

CIT 852:  
DATA COMMUNICATION AND NETWORK

---





**NATIONAL OPEN UNIVERSITY OF NIGERIA**

**FACULTY OF SCIENCE**

**COURSE CODE: CIT 852**

**COURSE TITLE:**

**DATA COMMUNICATION AND NETWORK**

# **COURSE GUIDE**

**CIT 852**

**DATA COMMUNICATION AND NETWORK**

**CREDIT UNIT: 3 CU**

Course Adapter

Afolorunso, A. A.

National Open University of  
Nigeria

Course Coordinator Afolorunso, A. A.

National Open University of Nigeria

**Course Reviewer**

**Prof. A.A. Obiniyi**

**Department of Computer  
Science**

**Ahmadu Bello University**

**Zaria, Kaduna State.**

**Nigeria**



**NATIONAL OPEN UNIVERSITY OF NIGERIA**

National Open University of Nigeria

Headquarters

14/16 Ahmadu Bello Way

Victoria Island

Lagos

Abuja Office

5, Dar Es Salaam Street

Off Aminu Kano Crescent Wuse II, Abuja Nigeria.

e-mail: [centralinfo@nou.edu.ng](mailto:centralinfo@nou.edu.ng)

URL: [www.nou.edu.ng](http://www.nou.edu.ng)

Published by

National Open University of Nigeria

Printed 2008

ISBN: 978-058-378-5

All Rights Reserved

**TABLE OF CONTENT**

**TABLE OF CONTENTS**

CIT 852 .....	3
DATA COMMUNICATION AND NETWORK .....	3

NATIONAL OPEN UNIVERSITY OF NIGERIA .....	4
TABLE OF CONTENT .....	4
LIST OF FIGURES .....	14
Introduction.....	19
What You Will Learn in this course .....	20
Course Aims.....	20
Course Objectives .....	20
Working through this Course.....	21
Course Materials .....	21
Study Units.....	21
Textbooks and References .....	22
Assignments File.....	22
Presentation Schedule .....	23
Assessment.....	23
Tutor Marked Assignment .....	23
Final Examination and Grading .....	24
Course Marking Scheme.....	25
Course Overview .....	25
How to Get the Best from this Course .....	26
Facilitators/Tutors and Tutorials.....	27
Summary .....	28
NATIONAL OPEN UNIVERSITY OF NIGERIA .....	29
NETWORK CONCEPTS .....	2
1.0 INTRODUCTION .....	3
2.0 OBJECTIVES .....	3
3.0 MAIN CONTENT .....	3
3.2 Network Goals and Motivations .....	5
3.3 Classification of Networks.....	6
3.3.1 Broadcast Networks .....	6
3.3.2 Point-to-Point or Switched Networks .....	8
SELF ASSESSMENT EXERCISE 1.....	10
3.4 Network Topology .....	10
3.4.1 Bus Topology.....	10
3.4.2 Star Topology.....	12
3.4.3 Ring Topology .....	12
3.4.4 Tree Topology.....	13
3.4.5 Mesh Topology .....	14
3.4.6 Cellular Topology .....	15

SELF ASSESSMENT EXERCISE 2.....	15
3.5 Applications of Network.....	16
3.6 Networking Model.....	17
3.6.1 OSI References Model.....	18
3.6.2 TCP/IP Reference Model.....	25
SELF ASSESSMENT EXERCISE 3.....	31
3.7 Network Architecture.....	31
1.8.1 Client/Server Architecture.....	31
3.7.2 Peer-to-Peer Architecture.....	33
3.8 Example Networks.....	33
3.8.1 Novell Netware.....	33
3.8.2 Arpanet.....	35
3.8.3 Internet.....	36
3.8.4 ATM Network.....	39
3.9 Types of Computer Networks.....	40
1.9.1 Metropolitan Area Network (MAN).....	40
3.9.2 Wide Area Network (WAN).....	41
3.9.3 Comparison between LAN, MAN, WAN and GAN.....	42
3.10 Advantages of Networks.....	42
4.0 CONCLUSION.....	43
5.0 SUMMARY.....	44
6.0 TUTOR MARKED ASSIGNMENT 1.....	44
7.0 REFERENCE/FURTHER READINGS.....	44
8.0 ANSWERS TO SELF-ASSESSMENT EXERCISES 1.....	44
ANSWERS TO SELF-ASSESSMENT EXERCISES 2.....	46
ANSWERS TO SELF-ASSESSMENT EXERCISES 3.....	48
9.0 ANSWERS TO TUTOR MARKED ASSIGNMENT 1.....	49
UNIT 2 DATA TRANSMISSION.....	51
1.0 INTRODUCTION.....	51
2.0 OBJECTIVES.....	52
3.1 Data Communication Terminology.....	52
3.1.1 Channel.....	52
3.1.2 Baud.....	53
3.1.3 Bandwidth.....	53
3.1.4 Frequency.....	53
3.2 Modes of Data Transmission.....	53
3.2.1 Serial and Parallel Communication.....	54
3.2.2 Asynchronous, Synchronous and Isochronous Communication.....	55

3.2.3 Simplex, Half Duplex and Full Duplex Communication.....	57
3.3 Analogue and Digital Data Transmission .....	60
3.4 Transmission Impairments .....	61
3.4.1 Attenuation.....	62
3.4.2 Delay Distortion.....	62
3.4.3 Noise .....	62
3.4.3 Concept of Delays .....	62
3.5 Transmission Media and its Characteristics.....	63
3.5.1 Magnetic Media .....	63
3.5.2 Twisted Pair .....	64
3.5.3 Baseband Coaxial Cable .....	65
3.5.4 Broadband Coaxial Cable .....	65
3.5.5 Optical Fibre .....	66
3.5.6 Comparison between Optical Fibre and Copper Wire.....	67
3.6 Wireless Transmission .....	68
3.6.1 Microwave Transmission.....	69
3.6.2 Radio Transmission .....	72
3.6.3 Infrared and Millimetre Waves .....	72
3.7 Wireless LAN .....	74
4.0 CONCLUSION.....	74
5.0 SUMMARY .....	74
6.0 TUTOR MARKED ASSIGNMENT 2 .....	75
7.0 REFERENCES/FURTHER READINGS .....	75
8.0 ANSWERS TO SELF-ASSESSMENT EXERCISES 4.....	75
9.0 ANSWERS TO SELF-ASSESSMENT EXERCISES 5.....	77
9.0 ANSWER TO TUTOR MARKED ASSIGNMENT 2.....	78
UNIT 3 DATA ENCODING AND COMMUNICATION TECHNIQUE ...	81
1.0 INTRODUCTION .....	81
2.0 OBJECTIVES .....	81
3.1 Encoding .....	82
3.2 Analogue- To-Analogue Modulation.....	82
3.3 Analogue to Digital Modulation .....	86
3.4 Digital to Analogue Modulation .....	88
3.5 Digital to Digital Encoding.....	93
4.0 CONCLUSION.....	97
5.0 SUMMARY .....	97
6.0 TUTOR MARKED ASSIGNMENT 3 .....	97
7.0 REFERENCES/FURTHER READINGS .....	98

8.0	ANSWERS TO SELF-ASSESSMENT 6 .....	98
9.0	ANSWERS TO TUTOR MARKED ASSIGNMENT 3 .....	100
	UNIT 4 MULTIPLEXING AND SWITCHING .....	105
1.0	INTRODUCTION .....	105
	106	
2.0	OBJECTIVES .....	106
3.1	Multiplexing.....	106
	3.1.1 Frequency Division Multiplexing .....	107
	3.1.2 Time Division Multiplexing .....	109
3.2	Digital Subscriber Lines .....	112
3.3	ADSL vs. Cable .....	113
3.4	Switching .....	114
	3.4.1 Circuit Switching .....	114
	3.4.2 Packet Switching.....	118
4.0	CONCLUSION.....	120
5.0	SUMMARY .....	120
6.0	TUTOR MARKED ASSIGNMENT 4 .....	120
7.0	REFERENCES/FURTHER READINGS .....	121
	MODULE 2: MEDIA ACCESS CONTROL AND DATA LINK LAYER.....	125
	UNIT 1 DATA LINK LAYER FUNDAMENTALS .....	125
1.0	INTRODUCTION .....	125
2.0	OBJECTIVES .....	126
3.1	Framing.....	126
	3.1.3 Bit Patterns.....	128
3.2	Basics of Error Detection.....	130
	3.2.1 Types of Error .....	130
	Lost Message (Frame).....	131
	3.2.2 Error Detection.....	131
	00000010 01010000 10101101.....	134
3.3	Forward Error Correction .....	134
3.4	Cyclic Redundancy Check Codes for Error Detection .....	136
3.5	Flow Control .....	139
	3.5.1 Slop and Wait.....	140
	3.5.2 Sliding Window Protocol.....	141
4.0	CONCLUSION.....	145
5.0	SUMMARY .....	145
6.0	TUTOR MARKED ASSIGNMENT 5 .....	145
7.0	REFERENCES/FURTHER READINGS .....	145



8.0	ANSWERS TO TUTOR MARKED ASSIGNMENTS 5.....	146
UNIT 2	RETRANSMISSION STRATEGIES .....	150
1.0	INTRODUCTION .....	150
	151	
2.0	OBJECTIVES .....	151
3.1	Stop & Wait ARQ.....	151
3.1.1	Normal Operation .....	152
3.1.1	When ACK is lost.....	152
3.1.3	When Frame is lost .....	153
3.1.4	When ACK time out occurs.....	153
3.2	Go-Back-N ARQ .....	155
3.3	Selective Repeat ARQ .....	155
3.4	Pipelining .....	156
3.5	Piggybacking.....	157
4.0	CONCLUSION.....	158
5.0	SUMMARY .....	158
6.0	TUTOR MARKED ASSIGNMENT 6 .....	159
7.0	REFERENCES/FURTHER READINGS.....	159
8.0	ANSWERS TO TUTOR MARKED ASSIGNMENT 6.....	159
UNIT 3	CONTENTION-BASED MEDIA ACCESS PROTOCOLS.....	161
1.0	INTRODUCTION .....	161
2.0	OBJECTIVES .....	162
3.1	Advantages of Multiple Access Sharing of Channel Resources.....	162
3.2	Pure ALOHA .....	163
3.3	Slotted ALOHA .....	165
3.4	Carrier Sense Multiple Access (CSMA).....	166
3.5	CSMA with Collision Detection (CSMA/CD) .....	167
3.6	Ethernet Frame Format (IEEE 802.3).....	169
4.0	CONCLUSION.....	171
5.0	SUMMARY .....	171
6.0	TUTOR MARKED ASSIGNMENT 7 .....	171
7.0	REFERENCES/FURTHER READINGS .....	171
8.0	ANSWERS TO TUTOR MARKED ASSIGNMENT 7 .....	172
UNIT 4	WIRELESS LAN AND DATA LINK LAYER SWITCHING.....	174
	CONTENTS.....	174
1.0	INTRODUCTION .....	174
2.0	OBJECTIVES .....	175
3.1	Introduction to Wireless LAN.....	175

3.2	Wireless LAN Architecture (IEEE 802.11)	175
3.3	Hidden Station and Exposed Station Problems	176
3.4	WIRELESS LAN PROTOCOLS: Multiple Access with Collision Avoidance (MACA) AND Media Access protocol for Wireless LANs (MACAW)	177
3.5	IEEE 802.11 Protocol Stack	179
3.5.1	The 802.11 Physical Layer	179
3.5.2	The 802.11 MAC Sub-layer Protocol	181
3.6	Switching at Data Link Layer	184
3.6.1	Operation of Bridges in Different LAN Environment	185
3.6.1	Transparent Bridges	187
3.6.2	Spanning Tree Bridges	188
3.6.3	Source Routing Bridges	188
4.0	CONCLUSION	189
5.0	SUMMARY	189
6.0	TUTOR MARKED ASSIGNMENT 8	189
7.0	REFERENCES/FURTHER READINGS	189
8.0	ANSWERS TO TUTOR MARKED ASSIGNMENT 8	190
MODULE 3 NETWORK LAYER		191
UNIT 1 INTRODUCTION TO LAYER FUNCTIONALITY AND DESIGN ISSUES		191
1.0	INTRODUCTION	192
2.0	OBJECTIVES	192
3.1	Connection Oriented vs. Connectionless Services	193
3.1.1	Connection-Oriented Services	193
3.1.2	Connection-less Services	194
3.2	Implementation of the Network Layer Services	195
3.2.1	Packet Switching	195
3.2.2	Implementation of Connection-oriented Services	196
3.2.3	Implementation of Connection-less Services	197
3.3	Comparison between Virtual Circuit and Datagram Subnet	199
SELF-ASSESSMENT EXERCISE 7		200
3.4	Addressing	200
3.4.1	Hierarchical vs. Flat Address	201
3.4.2	Static vs. Dynamic Address	202
3.4.3	IP Address	202
3.5	Concept of Congestion	203
3.6	Routing Concept	205

3.6.1 Main Issues in Routing .....	205
1.7.2 Classification of Routing Algorithm.....	207
4.0 CONCLUSION.....	207
5.0 SUMMARY .....	208
6.0 SELF ASSESSMENT EXERCISE 6.....	208
7.0 TUTOR MARKED ASSIGNMENT 9 .....	208
7.0 REFERENCES/FURTHER READINGS .....	208
8.0 ANSWERS TO SELF ASSESSMENT EXERCISE 6 .....	209
9.0 ANSWERS TO TUTOR MARKED ASSIGNMENT 9.....	209
UNIT 2 ROUTING ALGORITHMS.....	212
1.0 INTRODUCTION .....	212
2.0 OBJECTIVES .....	212
3.1 Flooding .....	213
SELF ASSESSMENT EXERCISE 7.....	214
3.2 Shortest Path Routing Algorithm .....	214
3.2.1: Dijkstra Algorithm.....	214
3.3 Distance Vector Routing.....	216
3.3.1 Comparison .....	218
3.3.2 The Count-to-Infinity Problem .....	219
3.4 Link State Routing .....	220
3.5 Hierarchical Routing .....	223
3.6 Broadcast Routing.....	225
3.7 Multicast Routing.....	227
4.0 CONCLUSION.....	229
5.0 SUMMARY .....	229
6.0 TUTOR MARKED ASSIGNMENT 10 .....	230
7.0 REFERENCES/FURTHER READINGS .....	230
8.0 ANSWERS TO TUTOR MARKED ASSIGNMENT 10.....	230
9.0 ANSWERS TO SELF-ASSESSMENT 7 .....	232
UNIT 3 CONGESTION CONTROL IN PUBLIC SWITCHED NETWORK	
232	
1.0 INTRODUCTION .....	233
233	
2.0 OBJECTIVES .....	233
3.1 Reasons for Congestion in the Network.....	233
3.2 Congestion Control Vs Flow Control .....	234
3.3 Congestion Prevention Mechanism .....	235
3.4 General Principles of Congestion Control .....	235

3.5	Open Loop Control .....	237
3.5.1	Admission Control .....	237
3.5.2	Traffic Policing and its Implementation .....	237
3.5.3	Traffic Shaping and its Implementation .....	238
3.5.4	Difference between Leaky Bucket Traffic Shaper and Token Bucket Traffic Shaper .....	240
3.6	Congestion Control in Packet-Switched Networks.....	240
4.0	CONCLUSION .....	241
5.0	SUMMARY .....	241
6.0	TUTOR MARKED ASSIGNMENT 11 .....	241
7.0	REFERENCES/FURTHER READINGS .....	242
8.0	ANSWER TO TUTOR MARKED ASSIGNMENT 11 .....	242
UNIT 4	INTERNETWORKING .....	244
1.0	INTRODUCTION .....	245
2.0	OBJECTIVES .....	245
3.1	Internetworking.....	245
3.1.2	Networks Connecting Mechanisms .....	246
3.1.3	Tunnelling and Encapsulation.....	248
3.2	Network Layer Protocols .....	248
3.2.1	IP Datagram Formats .....	249
3.2.2	Internet Control Message Protocol (ICMP) .....	259
3.2.3	OSPF: The Interior Gateway Routing Protocol .....	260
3.2.4	BGP: The Exterior Gateway Routing Protocol.....	261
	Internet Protocol Version 6 (IPv6).....	263
4.0	CONCLUSION .....	270
5.0	SUMMARY .....	270
6.0	TUTOR MARKED ASSIGNMENT 12 .....	270
7.0	REFERENCES/FURTHER READINGS .....	270
8.0	ANSWERS TO TUTOR MARKED ASSIGNMENT 12.....	271
MODULE 4	TRANSPORT LAYER AND APPLICATION LAYER SERVICES	273
UNIT 1	TRANSPORT SERVICES AND MECHANISM.....	273
1.0	INTRODUCTION .....	273
2.0	OBJECTIVES .....	274
3.1	Transport Services .....	274
3.1.1	Types of Services .....	275
3.1.2	Quality of Service .....	276
3.1.3	Data Transfer .....	277

3.1.4 Connection Management .....	278
3.1.5 Expedited Delivery .....	278
3.2 Elements of Transport Layer protocols.....	278
3.2.1 Addressing .....	278
3.2.2 Multiplexing.....	280
3.2.3 Flow Control and Buffering.....	281
3.2.4 Connection Establishment .....	284
3.1.5 Crash Recovery .....	285
4.0 CONCLUSION.....	285
5.0 SUMMARY .....	285
6.0 TUTOR MARKED ASSIGNMENT 13 .....	286
7.0 REFERENCES/FURTHER READINGS .....	286
8.0 ANSWERS TO TUTOR MARKED ASSIGNMENT 13 .....	286
UNIT 2 TCP/UDP.....	288
1.0 INTRODUCTION .....	288
288	
2.0 OBJECTIVES .....	288
3.1 Services Provided by Internet Transport Protocols .....	289
3.1.1 TCP Services.....	289
3.1.2 UDP Services .....	290
3.2 Introduction to UDP.....	290
3.3 Introduction to TCP .....	293
3.4 TCP Segment Header.....	293
3.5 TCP Connection Establishment .....	295
3.6 TCP Connection Termination .....	297
3.7 TCP Flow Control.....	298
3.8 TCP Congestion Control.....	301
3.9 Remote Procedure Call .....	304
4.0 CONCLUSION.....	306
5.0 SUMMARY .....	306
6.0 TUTOR MARKED ASSIGNMENT 14 .....	306
7.0 REFERENCES/FURTHER READINGS .....	307
8.0 TUTOR MARKED ASSIGNMENT 14 .....	307
1.0 INTRODUCTION .....	309
2.0 OBJECTIVES .....	310
3.1 Cryptography .....	310
3.2 Symmetric Key Cryptography .....	311
SELF ASSESSMENT EXERCISE 8.....	328

3.3	Public Key Cryptography .....	329
3.3.1	RSA Public Key Algorithm (Rivest-Shamir-Adelman Algorithm).....	333
3.3.2	Diffie-Hellman.....	335
3.3.3	Elliptic Curve Public Key Cryptosystems .....	336
3.3.4	DSA.....	338
3.4	Mathematical Background .....	341
3.4.1	Exclusive OR (XOR) .....	341
3.4.2	The Modulo Function .....	342
4.0	CONCLUSION.....	343
5.0	SUMMARY .....	343
6.0	TUTOR MARKED ASSIGNMENT 15 .....	344
7.0	REFERENCES/FURTHER READINGS .....	344
8.0	ANSWERS TO TUTOR MARKED ASSIGNMENT 15.....	344
8.0	ANSWERS TO SELF-ASSESSMENT EXERCISE 8.....	345
UNIT 4	NETWORK SECURITY-II .....	346
1.0	INTRODUCTION .....	346
2.0	OBJECTIVES .....	347
3.1	Digital Signatures.....	347
	Figure 11: Issuing of a digital certificate by the certifying authority Uses of Digital Signature .....	352
	SELF ASSESSMENT EXERCISE 9.....	353
3.3	Management of Public Keys .....	353
3.3	Communication Security .....	358
3.4	Web Security.....	368
4.0	CONCLUSION.....	371
5.0	SUMMARY .....	371
6.0	TUTOR MARKED ASSIGNMENT 16 .....	372
7.0	REFERENCES/FURTHER READINGS .....	372
8.0	ANSWERS TO SELF ASSESSMENT EXERCISE 9 .....	372
9.0	ANSWERS TO TUTOR-MARKED ASSIGNMENT 16.....	373

## **LIST OF FIGURES**

Figure 1.1: A computer-networked environment.....	4
---	---

Figure 1.2: Bus topology.....	11
Figure 1.3: Star topology .....	12
Figure 1.4: Ring Topology.....	12
Figure 1.5: Tree Topology .....	13
Figure 1.6: Mesh Topology.....	14
Figure 1.7: Cellular Topology.....	15
Figure 1.8: Layered network architecture .....	18
Figure 1.9: Layers or OSI Reference Model.....	19
Figure 1.10: Data package names in the OSI reference model.....	23
Figure 1.11: Working of OSI Reference Model .....	24
Figure 1.12: Layers of TCP/IP reference model.....	25
Figure 1.13: Comparison between OSI and TCP/IP reference model .....	29
Figure 1.14: Difference between OSI and TCP/IP reference model.....	30
Figure 1.15: Client/Server Architecture.....	31
Figure 1.16: Peer-to-peer architecture .....	33
Figure 1.17: The Novell NetWare reference model.....	35
Figure 1.18: Working of internet .....	38
Figure 1.19: Metropolitan Area network .....	40
Figure 1.20: Wide area network.....	41
Figure 1.21: Comparison between different types of networks.....	42
Figure 1.22: Serial Communication .....	54
Figure 1.23: Parallel Data Transmission.....	54
Figure 1.24: Simplex connection .....	58
Figure 1.25: Half duplex connection .....	58
Figure 1.26: Full duplex connection .....	59
Figure 1.27: Analogue signal .....	60
Figure 1.28: Digital Data Transmission.....	61
Figure 1.29: Twisted pair cable .....	64
Figure 1.30: Coaxial cable .....	65
Figure 1.31: Optical fibre.....	66
Figure 1.32: Frequency spectrum for Wireless Transmission .....	68
Figure 1.33: Microwave transmission station.....	69
Figure 1.34: Encoding/Conversion Techniques.....	81
Figure 1.35: Amplitude modulation.....	84
Figure 1.36: Frequency modulation .....	85
Figure 1.37: Phase Modulation .....	86
Figure 1.38 : Pulse Code Modulation .....	88
Figure 1.39; digital to analogue modulation techniques.....	89
Figure 1.40: Amplitude Shift Keying. ....	90
Figure 1.41: Frequency Shift Keying.....	91
Figure 1.42: 8 PSK.....	91
Figure 1.43: 8 PSK.....	92
Figure 1.44: 8-QAM and 8-QAM constellations .....	92
Figure 1.45: Unipolar encoding .....	93
Figure 1.46: NRZ -L and NRZ-I encoding .....	95
Figure 1.47: RZ encoding .....	95
Figure 1.48: Manchester and differential Manchester encoding.....	96
Figure 1.49: Bipola Encoding .....	96
Figure 1.50: Frequency division multiplexing.....	108
Figure 1.51: Analogue hierarchy .....	109
Figure 1.52: Time division multiplexing .....	109

Figure 1.53: Circuit Switching.....	115
Figure 1.54: Multistage Switch.....	116
Figure 1.55: Picket switching .....	118
Figure 2.1: Data link layer providing services to network layer.....	126
Figure 2.2: Frame format .....	127
Figure 2.3: Character count.....	127
Figure 2. 4: Problem in character count.....	127
Figure 2. 5: Character patterns (Character stuffing) .....	128
Figure 2.6a: Before stuffing .....	128
Figure 2.7 (a): Original' data ready to be sent .....	129
Figure 2.8: 1bit error .....	130
Figure 2.9: Burst error.....	130
Figure 2.10 : Error Detection .....	131
Figure 2.11: Forward Error Correction .....	135
Figure 2.12: Error Correction .....	136
Figure 2.13: Cyclic redundancy check .....	138
Figure 2.14: Cyclic redundancy check the receiver side .....	139
Figure 2.15: Stop and Wait .....	140
Figure 2.16: Normal now diagram of sliding.....	142
Figure 2.17: Sending Window in I Sliding Window .....	143
Figure 2.18: Receiving window in 1 sliding window .....	143
Figure 2.19: Function of a sliding window machine .....	144
Figure 2.20: Stop and wait protocol.....	152
Figure 2.21: Loss of ACK.....	153
Figure 2.22: Loss of a frame .....	153
Figure 2. 23: ACK lime out .....	154
Figure 2. 24: Piggybacking 1 .....	154
Figure 2. 25: Go-Back-N .....	155
Figure 2.26: Selective Repeat .....	156
Figure 2. 27: Pipelining in Go-Bank-N.....	157
Figure 2.28: Pipelining in selective repeat.....	157
Figure 2.29: Piggybacking .....	158
Figure 2. 30: Shared media .....	161
Figure 2. 31: Channel allocation technique .....	162
Figure 2.32: ALOHA .....	163
Figure 2.33: Vulnerable period .....	164
Figure 2.34: Throughput vs. load graph of pure ALOHA .....	165
Figure 2.35: Throughput vs. load graph of slotted ALOHA.....	166
Figure 2.36: Collision detection.....	168
Figure 2.37: Transmission states.....	168
Figure 2.38: Characteristics of Ethernet Cable .....	169
Figure 2.39: Ethernet Frame Format.....	170
Figure 2.40: Wireless LAN architecture .....	176
Figure 2.41: Hidden and exposed station problem .....	177
Figure 2.42: MACA Protocol .....	178
Figure 2.43: The MACAW protocol.....	178
Figure 2.44: Part of the 802.11 protocol tack .....	179
Figure 2.45: (a) The hidden station problem .....	181
Figure 2.46: The use of virtual channel sensing using CSMA/CA.....	182
Figure 2.47: A fragment burst.....	183



Figure 2.48: Multiple LANs connected by backbone to handle a total load higher than the capacity of single LAN .....	185
Figure 2.49: Three LANS and two bridges.....	188
Figure 3.1: A Packet switched network .....	195
Figure 3.2: Routing in a virtual subnet .....	197
Figure 3.3: Routing table for VC subnet.....	197
Figure 3.4: Routing in a datagram subnet.....	198
Table 3.5: Comparison between Virtual Circuit and Datagram Subnets (Source: Ref. [1]).....	200
Figure 3.6: MAC addresses, data-link addresses, and the IEEE Sub-layer, of the data link layer are all related.....	201
Figure 3.7: Hierarchical and flat address spaces differ in comparison operations.....	202
Figure 3.8: IP address .....	203
Figure 3.9: Congestion.....	203
Figure 3.10: interaction of routing and now control .....	206
Figure 3.11: Throughput vs. delay graph.....	206
Figure 3.12: Example a sub network .....	207
Figure 3.13: Broadcasting (Source: Ref [2J]) .....	214
Figure 3.14(a) Dijkstra Algorithm A .....	215
Figure 3.15: Public Switched Network.....	218
Figure 3.16: Link Cost (Ref. Source [3]).....	218
Figure 3.17(a): five node subnets.....	219
Figure 3.18: Link State Packet (LSP) .....	221
Figure 3.19: A subnet for link state routing.....	222
Figure 3.20: The link state packets (LSPs) for the subnet in figure .....	222
Figure 3.21: typical graph and routing table.....	224
Figure 3.22: Network graph.....	224
Figure 3.23: A's Routing table for Hierarchical! Routing.....	224
Figure 3.24: Hierarchical routing.....	225
Figure 3.25: Network containing two groups i.e., 1 and 2.....	227
Figure 3.26: Spanning tree for the leftmost router.....	228
Figure 3.27: A pruned spanning multicast tree for group 1 .....	228
Figure 3.28: A pruned spanning multicast tree for group 2 .....	229
Figure 3.29: Congestion in Network.....	233
Figure 3.30: Congestion Control vs. Flow Control.....	234
Table 3.31: Mechanism Affecting Congestion .....	235
Figure 3.32: Possible traffic patterns at the average rate of 30 Kbps .....	238
Figure 3.33: A leaky bucket traffic shaper.....	239
Figure 3.34: Token bucket traffic shaper .....	240
Figure 3.35: Leaky Bucket Traffic Shaper and Token Bucket Traffic Shaper .....	240
Figure 3.36: Different type of Networks.....	246
Figure 3.37: Network layer protocols .....	249
Figure 3.38 (a): IP datagram .....	249
Figure 3.39: IP address classes in dotted decimal formal with their range.....	253
Figure 3.40: Private Addresses Provided in RFC 1918 .....	257
Figure 3.41: Fragmentation Table.....	259
Figure 3.42: Working domain of OSPF .....	261
Figure 3.43: Solution to Count to infinity problems in BGP .....	262
Figure 4.1: Transport entity environment .....	274

Figure 4.2: Transport connections between a client and a server .....	279
Figure 4.3: Multiplexing .....	280
Figure 4.4: Flow control and buffering.....	284
Figure 4.5: UDP segment structure.....	292
Figure 4.6: TCP header format .....	294
Figure 4.7: Three-way handshake mechanism.....	297
Figure 4.8: Dynamics of TCP congestion window .....	303
Figure 4.9: Concept of local procedure call.....	305
Figure 4.10: Concept of remote procedure call .....	305
Figure 4.11: Secret Key Cryptography .....	311
Figure 4.12: Block cipher .....	312
Figure 4.13: Stream cipher linear feedback shift register (LFSR).....	312
Figure 4.14: Substitution.....	313
Figure 4.15: Transition.....	313
Figure 4.16: Feistel' Cipher .....	314
Figure 4.17: Cipher block chaining .....	315
Figure 4.18: Cipher feedback model.....	316
Figure 4.19: Output feedback block.....	316
Figure 4.20: DES; algorithm.....	318
Figure 4.21: Algorithm .....	323
Figure 4.22: Transmission Rounds (NV) in Rijndael .....	324
Table 4.23: Supported Variables.....	324
Figure 4.24: Shiftrows Transformation.....	325
Figure 4.25: 192-bit Cipher key.....	327
Figure 4.26: Digital Signature.....	330
Figure 4.27: Digital signature verification process.....	330
Figure 4.28: Encryption and decryption process .....	333
Figure 4.29: Elliptic Curve Cryptography .....	337
Figure 4.30: Relationship between ECC and RSA .....	338
Figure 4.31: Digital signature .....	347
Figure 4.32: Encryption and signing using public key cryptography .....	348
Figure 4.33: Explanation using an example.....	348
Figure 4.34: Ram's co-workers.....	348
Figure 4.35: Encryption of a message using public key of Ram .....	349
Figure 4.36: Hashing and Message Digest.....	349
Figure 4.37: Encryption of message digest using private key .....	350
Figure 4.38: Append the digital signature to the document.....	350
Figure 4.39: The decryption using private key .....	350
Figure 4.40: Creation of a digital certificate.....	351
Figure 4.41: Digital Certificate .....	352
Figure 4.42: Hierarchical model being followed in India.....	354
Figure 4.43: The CCITT-ITU/ISO X.509 certificate format .....	355
Figure 4.44: CRL format (version 2) .....	356
Figure 4.45: Kerberos .....	359
Figure 4.46: Services of PGP.....	360
Figure 4.47: Firewall inspects traffic, and encapsulates and encrypt traffic Secure Sockets Layer (SSL) .....	362
Figure 4.48: Secure socket layer (SSL). .....	362
Figure 4.49: Protocol redirector.....	365

## **Introduction**

CIT 852 -Data Communication and Networks is a three [3] credit unit course of 16 units. The main objective of the course is to deal with fundamental issues in Computer Networks. It starts with the philosophy of data communication covering different modulation and multiplexing techniques. Then, it proceeds to cover

MAC layer protocols, several routing techniques protocols, congestion techniques and several network layer protocol. The final module of the course takes up issues related to the transport layer mechanism, such as, addressing, connection, establishment, flow control and multiplexing issues. It also covers the transport layer protocol in details. The module ends with the security issue, which is an important topic today.

This Course Guide gives you a brief overview of the course content, course duration, and course materials.

## **What You Will Learn in this course**

The main purpose of this course is to deal with fundamental issues in Computer Networks. It makes available the steps and tools that will enable you to make proper and accurate decision about data transmission and computer systems connectivity whenever the need arises. This, we intend to achieve through the following:

### **Course Aims**

- i. Introduce the concepts data communication and computer networks;
- ii. Provide in-depth knowledge of Data Link Layer fundamental such as, error detection, correction, and flow techniques; as well as introduce data link layer switching concepts;
- iii. Discuss the concept of routing and congestion as well as highlight the different routing and congestion control algorithms; and
- iv. Introduce internetworking concepts and protocols;
- v. Discuss topics like network security which include symmetric key algorithm, public key algorithm, digital signature, etc. as well as topics like addressing, multiplexing, connection establishment, crash recovery and TCPIUDP Protocols.

### **Course Objectives**

Certain objectives have been set out to ensure that the course achieves its aims. Apart from the course objectives, every unit of this course has set objectives. In the course of the study, you will need to confirm, at the end of each unit, if you have met the objectives set at the beginning of each unit. By the end of this course you should be able to:

- i. describe the various components and data communication and computer networking;
- ii. differentiate between different types of computer networks; iii. compare the different network topologies;
- iv. describe the mechanism and techniques of encoding;
- v. describe a wireless LAN and Data Link Layer switching, and operations of bridges;

- vi. explain the Routing concept;
- vii. explain the basic principle of internetworking and its importance;
- viii. describe the whole concept/idea behind network security as well as the various network/data security algorithms

## Working through this Course

In order to have a thorough understanding of the course units, you will need to read and understand the contents, **practice** the steps by designing and implementing a mini LAN for your department, and be committed to learning and implementing your knowledge.

This course is designed to cover approximately eighteen weeks, and it will require your devoted attention. You should do the exercises in the Tutor-Marked Assignments and submit to your tutors.

## Course Materials

These include:

1. Course Guide
2. Study Units
3. Recommended Texts
4. A file for your assignments and for records to monitor your progress.

## Study Units

There are sixteen study units in this course:

### **Module 1                      Introduction to Data Communication and Computer Network Concepts**

- Unit 1                      Introduction to Computer Networks
- Unit 2                      Data Transmission
- Unit 3                      Data Encoding and Communication Technique
- Unit 4                      Multiplexing and Switching

### **Module 2                      Media Access Control and Data Link Layer**

- Unit 1                      Data Link Layer Fundamentals
- Unit 2                      Retransmission Strategies
- Unit 3                      Contention-Based Media Access Protocols
- Unit 4                      Wireless LAN and Datalink Layer Switching

### **Module 3                      Network Layer**

- Unit 1                      Introduction to Layer Functionality and Design Issues

Unit 2	Routing Algorithms
Unit 3	Congestion Control in Public Switched Network
Unit 4	Internetworking

**Module 4                      Transport Layer and Application Layer Services**

Unit 1	Transport Services and Mechanism
Unit 2	TCPIUDP
Unit 3	Network Security I
Unit 4	Network Security II

Make use of the course materials, do the exercises to enhance your learning.

**Textbooks and References**

*Computer Networks*, Andrew S. Tanenbaum, PHI, New Delhi.

*Data and Computer Communication*, William Stalling, PHI, New Delhi.

*Computer Communications and Networking Technologies*, by Michael A. Gallo and William M. Hancock, Thomson Asia, Second Reprint, 2002.

*Introduction to Data Communications and Networking*, by Behrouz Forouzan, Tata McGraw-Hill, 1999.

*Networks*, Tirothy S. Ramteke, Second Edition, Pearson Education, New Delhi.

*Communications Networks*, Leon Garcia, and Widjaja, Tata McGraw- Hill, 1999.

*Computer Networking*, J. F. Kurose & K. W. Ross, A Top Down Approach Featuring the Internet, Pearson Edition, 2003.

*Computer Networks*, Andrew S. Tanenbaum 4th Edition Prentice Hall of India, New Delhi. 2003.

*Communication Networks, Fundamental Concepts and Key Architectures*, Leon and Widjaja, 3rd Edition, Tata McGraw-Hill.

*Data Network*, Dmitri Bertsekas and Robert Gallager, Second Edition, Prentice Hall of India, 1997, New Delhi.

*Network Security Essential -Application and Standard*, William Stallings, Pearson Education, New Delhi.

**Assignments File**

These are of two types: the self-assessment exercises and the Tutor- Marked Assignments. The self-assessment exercises will enable you monitor your performance by yourself, while the Tutor-Marked Assignment is a supervised assignment. The assignments take a certain percentage of your total score in this course. The Tutor-Marked Assignments will be assessed by your tutor within a specified period. The examination at the end of this course will aim at determining the level of mastery of the subject matter. This course includes twelve Tutor-Marked Assignments and each must be done and submitted accordingly. Your best scores however, will be recorded for you. Be sure to send these assignments to your tutor before the deadline to avoid loss of marks.

## **Presentation Schedule**

The Presentation Schedule included in your course materials gives you the important dates for the completion of tutor marked assignments and attending tutorials. Remember, you are required to submit all your assignments by the due date. You should guard against lagging behind in your work.

## **Assessment**

There are two aspects to the assessment of the course. First are the tutor marked assignments; second, is a written examination.

In tackling the assignments, you are expected to apply information and knowledge acquired during this course. The assignments must be submitted to your tutor for formal assessment in accordance with the deadlines stated in the Assignment File. The work you submit to your tutor for assessment will count for 30% of your total course mark.

At the end of the course, you will need to sit for a final three-hour examination. This will also count for 70% of your total course mark.

## **Tutor Marked Assignment**

There are sixteen tutor marked assignments in this course. You need to submit all the assignments. The total marks for the best four (4) assignments will be 30% of your total course mark.

Assignment questions for the units in this course are contained in the Assignment File. You should be able to complete your assignments from the information and materials contained in your set textbooks, reading and study units. However, you may wish to use other references to broaden your viewpoint and provide a deeper understanding of the subject.

When you have completed each assignment, send it together with form to your tutor. Make sure that each assignment reaches your tutor on or before the deadline given. If, however, you cannot complete your work on time, contact your tutor before the assignment is due to discuss the possibility of an extension.

## **Final Examination and Grading**

The final examination for the course will carry 70% percentage of the total marks available for this course. The examination will cover every aspect of the course, so you are advised to revise all your corrected assignments before the examination.

This course endows you with the status of a teacher and that of a learner. This means that you teach yourself and that you learn, as your learning capabilities would allow. It also means that you are in a better position to determine and to ascertain the what, the how, and the when of your language learning. No teacher imposes any method of learning on you.

The course units are similarly designed with the introduction following the table of contents, then a set of objectives and then the dialogue and so on.

The objectives guide you as you go through the units to ascertain your knowledge of the required terms and expressions.



## Course Marking Scheme

This table shows the actual course marking is broken down.

Assessment	Marks
Assignment 1-4	Four Assignments, best three marks of the four count at 30% of course marks. .
Final examination	70% of overall course marks
Total	100% of course marks

Table 1: Course Marking Scheme

### Course Overview

Unit	Title of Work	Weeks Activity	Assignment (End of Unit)
	Course Guide	Week 1	
<b>Module 1</b>			
1	Introduction to computer Networks	Week 1	Assignment 1
2	Data Transmission	Week 2	Assignment 2
3	Data Encoding and Communication Technique	Week 3	Assignment 3
4	Multiplexing and Switching	Week 4	Assignment 4
<b>Module 2</b>			
1	Data Link Layer Fundamentals	Week 5	Assignment 5
2	Retransmission Strategies	Week 6	Assignment 6
3	Contention-Based Media Access Protocols	Week 7	Assignment 7
4	Wireless LAN and Datalink Layer Switching	Week 8	Assignment 8
<b>Module 3</b>			
1	Introduction to Layer Functionality and Design Issues	Week 9	Assignment 9
2	Routing Algorithms	Week 10	Assignment 10
3	Congestion Control in Public Switched Network	Week 11	Assignment 11
4	Internet work	Week 12	Assignment 12
<b>Module 4</b>			
1	Transport services and Mechanism	Week 13	Assignment 13
2	TCP/UDP	Week 14	Assignment 14
3	Network Security I	Week 15	Assignment 15
4	Network Security II	Week 16	Assignment 16
	Revision	Week 17	
	Examination	Week 18	
	<b>Total</b>	<b>Week 18</b>	

## How to Get the Best from this Course

In distance learning the study units replace the university lecturer. This is one of the great advantages of distance learning; you can read and work through specially designed study materials at your own pace, and at a time and place that suit you best. Think of it as reading the lecture instead of listening to a lecturer. In the same way that a lecturer might set you some reading to do, the study units tell you when to read your set books or other material. Just as a lecturer might give you an in-class exercise, your study units provide exercises for you to do at appropriate points.

Each of the study units follows a common format. The first item is an introduction to the subject matter of the unit and how a particular unit is integrated with the other units and the course as a whole. Next is a set of learning objectives. These objectives enable you know what you should be able to do by the time you have completed the unit. You should use these objectives to guide your study. When you have finished the units you must go back and check whether you have achieved the objectives. If you make a habit of doing this you will significantly improve your chances of passing the course.

Remember that your tutor's job is to assist you. When you need help, don't hesitate to call and ask your tutor to provide it.

1. Read this Course Guide thoroughly.
2. Organize a study schedule. Refer to the 'Course Overview' for more details. Note the time you are expected to spend on each unit and how the assignments relate to the units. Whatever method you chose to use, you should decide on it and write in your own dates for working on each unit.
3. Once you have created your own study schedule, do everything you can to stick to it. The major reason that students fail is that they lag behind in their course work.
4. Turn to Unit 1 and read the introduction and the objectives for the unit.
5. Assemble the study materials. Information about what you need for a unit is given in the 'Overview' at the beginning of each unit. You will almost always need both the study unit you are working on and one of your set of books on your desk at the same time.
6. Work through the unit. The content of the unit itself has been arranged to provide a sequence for you to follow. As you work through the unit you will be instructed to read sections from your set books or other articles. Use the unit to guide your reading.
7. Review the objectives for each study unit to confirm that you have achieved them. If you feel unsure about any of the objectives, review the study material or consult your tutor.

8. When you are confident that you have achieved a unit's objectives, you can then start on the next unit. Proceed unit by unit through the course and try to pace your study so that you keep yourself on schedule.
9. When you have submitted an assignment to your tutor for marking, do not wait for its return before starting on the next unit. Keep to your schedule. When the assignment is returned, pay particular attention to your tutor's comments, both on the tutor-marked assignment form and also written on the assignment. Consult your tutor as soon as possible if you have any questions or problems.
10. After completing the last unit, review the course and prepare yourself for the final examination. Check that you have achieved the unit objectives (listed at the beginning of each unit) and the course objectives (listed in this Course Guide).

## **Facilitators/Tutors and Tutorials**

There are 15 hours of tutorials provided in support of this course. You will be notified of the dates, times and location of these tutorials, together with the name and phone number of your tutor, as soon as you are allocated a tutorial group.

Your tutor will mark and comment on your assignments, keep a close watch on your progress and on any difficulties, you might encounter and provide assistance to you during the course. You must mail or submit your tutor-marked assignments to your tutor well before the due date (at **least** two working days are required). They will be marked by your tutor and returned to you as soon as possible.

Do not hesitate to contact your tutor by telephone, or e-mail if you need help. The following might be circumstances in which you would find help necessary. Contact your tutor if:

you do not understand any part of the study units or the assigned readings, you have difficulty with the self-tests or exercises, you have a question or problem with an assignment, with your tutor's comments on an assignment or with the grading of an assignment.

You should try your best to attend the tutorials. This is the only chance to have face to face contact with your tutor and to ask questions which are answered instantly. You can raise any problem encountered in the course of your study. To gain the maximum benefit from course tutorials, prepare a question list before attending them. You will learn a lot from participating in discussions actively.

## Summary

This is course, Data communication and Networks exposes you to basic knowledge and skills about data communication and computer networking you need to acquire as an information technology professional. The content of the course material was planned and written to build upon whatever knows you have acquired at undergraduate or post graduate diploma level and to ensure that you acquire the proper knowledge and skills for the appropriate situations. Real-life situations have been created to enable you identify with and create some of your own. The essence is to get you to acquire the necessary knowledge and competence, and by equipping you with the necessary tools, we hope to have achieved that.

I wish you success with the course and hope that you will find it both interesting and useful.

Course Code	CIT 852
Course Title	Data Communication and Network
Course Adapter	Afolorunso, A. A. National Open University of Nigeria
Course Coordinator	Afolorunso, A. A. National Open University of Nigeria

### Course Reviewer

Prof. A.A. Obinyi  
Department of Computer Science  
Ahmadu Bello University  
Zaria, Kaduna State.  
Nigeria



## NATIONAL OPEN UNIVERSITY OF NIGERIA

National Open University of Nigeria  
Headquarters  
14/16 Ahmadu Bello Way  
Victoria Island  
Lagos

Abuja Office  
5, Dar Es Salaam Street  
Off Aminu Kano Crescent Wuse II, Abuja Nigeria.

e-mail: [centralinfo@nou.edu.ng](mailto:centralinfo@nou.edu.ng) URL: [www.nou.edu.ng](http://www.nou.edu.ng)

Published by  
National Open University of Nigeria

Printed 2008  
**Second Print 2020**

ISBN: 978-058-378-5

All Rights Reserved

**MODULE 1                    INTRODUCTION TO DATA  
   COMMUNICATION AND COMPUTER  
   NETWORK CONCEPTS**

- Unit 1            Introduction to Computer Networks
- Unit 2            Data Transmission
- Unit 3            Data Encoding and Communication Technique
- Unit 4            Multiplexing and Switching

**UNIT 1            INTRODUCTION TO COMPUTER NETWORKS**

**CONTENT**

- 1.0            Introduction
- 2.0            Objectives
- 3.0            Main Content
  - 3.1            What is a Computer Network?
  - 3.2            Network Goals and Motivations
  - 3.3            Classification of Networks
    - 3.3.1 Broadcast Networks
    - 3.3.2 Point-to-Point or Switched Networks
  - 3.4            Network Topology
    - 3.4.1 Bus Topology
    - 3.4.2 Star Topology
    - 3.4.3 Ring Topology
    - 3.4.4 Tree Topology
    - 3.4.5 Mesh Topology
    - 3.4.6 Cellular Topology
  - 3.5            Applications of Network
  - 3.6            Networking Model
    - 3.6.1 OSI Reference Model
    - 3.6.2 TCP/IP Reference Model
  - 3.7            Network Architecture
    - 3.7.1 Client/Server Architecture
    - 3.7.2 Peer-to-Peer Architecture
  - 3.8            Example Networks
    - 3.8.1 Novell Netware
    - 3.8.2 ARPANET
    - 3.8.3 Internet
    - 3.8.4 ATM Network
  - 3.9            Types of Computer Networks
    - 3.9.1 Metropolitan Area Network (MAN)
    - 3.9.2 Wide Area Network (WAN)
    - 3.9.3 Comparison between LAN, MAN, WAN and GAN
  - 3.10          Advantages of Networks
- 4.0            Conclusion
  - 5.0            Summary
  - 6.0            Tutor-Marked Assignment
  - 7.0            References/Further Readings



## 1.0 INTRODUCTION

These days, practically every business, no matter how small uses computers to handle various transactions and as business grows, they often need several people to input and process data simultaneously and in order to achieve this, the earlier model of a single computer serving all the organisations computational needs has been replaced by a model in which a number of separate but interconnected computers do the job and this model is known as a Computer **Network**. By linking individual computers over a network their productivity has been increased enormously.

A most distinguishing characteristic of a general computer network is that data can enter or leave at any point and can be processed at any workstation. For example: A printer can be controlled from any word processor at any computer on the network. This is an introductory unit where, you will be learning about the basic concepts regarding Computer Networks. Here, you will learn about Networks, different types of Networks, their applications, Network topology, Network protocols, OSI Reference **Model**, TCP/IP Reference Model. We shall also examine some of the popular computer networks like Novell network, ARPANET, Internet, and ATM networks.

Towards **the** end of this unit, the concept of Delays in computer networks is also discussed.



## 2.0 OBJECTIVES

After going through this unit, you should be able to:

1. understand the concept of computer networks
2. differentiate between different types of computer networks
3. understand the different application of networks
4. compare the different network topologies
5. signify the importance of network protocols
6. know the importance of using networked system
7. understand the layered organisation and structuring of computer networks using OSI and TCPIIP reference model
8. have a broad idea about some of the popular networks like Novell network, ARPANET, INTERNET, ATM etc., and
9. understand the concept of delays.



## 3.0 MAIN CONTENT

### 3.1 What is a computer network?



**Figure 1.1:** A computer-networked environment

A Computer network consists of two or more autonomous computers that are linked (connected) together in order to:

1. Share resources (files, printers, modems, fax machines).
2. Share Application software like MS Office.
3. Allow Electronic communication.
4. Increase productivity (makes it easier to share data amongst users).

Figure 1 shows people working in a networked environment. The Computers on a network may be linked through Cables, telephones lines, radio waves, satellites etc.

A Computer network includes, the network operating system in the client and server machines, the cables, which connect different computers and all supporting hardware such as bridges, routers and switches. In wireless systems, antennas and towers are also part of the network.

Computer networks are generally classified according to their structure and the area they are localized in as:

- 1. Local Area Network (LAN):** The network that spans a relatively small area that is, in the single building or campus is known as LAN. It usually functions at 300m with to 100GPS data rate but can be upscaled to a few kms by employing Optical Fibre as a channel of sending signals. LAN is sometimes refers to as Ethernet. It is in most cases made use of networking in homes, offices, schools or school laboratories, network between two or few computers and WIFI in wireless LAN. Local Area Network (LAN): can be further divided into:
  - a. Personal Area Network (PAN)
  - b. Storage Area Network (SAN)
  - c. Enterprise Private Network (EPN)
  - d. Virtual Private Network (VPN)

### **Personal Area Network**

This can be wired or wireless depending on the devices that are used for the connection but centred on an individual person. It covers an area between 10 to 100m



in most cases at a few kbps to few Mbps data rates. Bluetooth, ZigBee, USB, firewire, WIFI-direct, near share (in windows 10) and part of IEEE802.15x standard are examples of PAN.

### **Storage Area Network (SAN)**

SAN as the name of the acronym implies is a local storage on different devices which works on disk blocks. Its pave way for a group of block-level storage. Most of the time, SAN path way to connect storage devices such as disk arrays and tape library from servers to enable machines manifest to the operating system as direct-attached storage. There is no direct access between SAN and LAN, however, SAN can be accessed by LAN through shared-disk file system constructed on top of SAN.

### **Enterprise Private Network (EPN)**

This is a network solely managed by one organization but may have diverse locations for example, production sites, shops and offices.

### **Virtual Private Network (VPN)**

This may be an extension of EPN across public network so that communication can be undertaken as if it is within a private network. It has the advantages of private network such as security and administration of the private network. Other types of LAN are peer-to-peer network and server-based network.

- 2. Metropolitan Area Network (MAN):** The type of computer network that is, designed for a city or town is known as MAN.
- 3. Wide Area Network (WAN):** A network that covers a large geographical area and covers different cities, states and sometimes even countries, is known as WAN. **All these networks can either be wired or wireless.**

The additional characteristics that are also used to categorise different types of networks are:

- 1. Topology:** Topology is the graphical arrangement of computer systems in a network. Common topologies include a bus, star, ring, and mesh.
- 2. Protocol:** The protocol defines a common set of rules which are used by computers on the network that communicate between hardware and software entities. One of the most popular protocols for LANs is the Ethernet. Another popular LAN protocol for PCs is the token-ring network.
- 3. Architecture:** Networks can be broadly classified as using either a peer-to-peer or client/server architecture.

## **3.2 Network Goals and Motivations**

Before designing a computer network we should see that the designed network fulfils the basic goals. We have seen that a computer network should satisfy a broad range of purposes and should meet various requirements. One of the main goals of a computer network is to enable its users to share resources, to provide low cost facilities and easy addition of new processing services. The computer network thus, creates a global environment for its users and computers.

Some of the basic goals that a Computer network should satisfy are:

1. Cost reduction by sharing hardware and software resources.
2. Provide high reliability by having multiple sources of supply.
3. Provide an efficient means of transport for large volumes of data among various locations (High throughput).
4. Provide inter-process communication among users and processors.
5. Increase productivity by making it easier to share data amongst users.
6. Repairs, upgrades, expansions, and changes to the network should be performed with minimal impact on the majority of network users.
7. Standards and protocols should be supported to allow many types of equipment from different vendors to share the network (interoperability).
8. Provide centralised/distributed management and allocation of network resources like host processors, transmission facilities etc.

### **3.3 Classification of Networks**

Depending on the transmission technology i.e., whether the network contains switching elements or not, we have two types of networks:

1. Broadcast networks.
2. Point-to-point or Switched networks.

#### **3.3.1 Broadcast Networks**

Broadcast networks have a single communication channel that is shared by all the machines on the network. In this type of network, short messages sent by any machine are received by all the machines on the network. The packet contains an address field, which specifies for whom the packet is intended. All the machines, upon receiving a packet check for the address field, if the packet is intended for itself, it processes it and if not, the packet is just ignored.

Using Broadcast networks, we can generally address a packet to all destinations (machines) by using a special code in the address field. Such packets are received and processed by all machines on the network. This mode of operation is known as “Broadcasting”. Some Broadcast networks also support transmission to a subset of machines and this is known as “Multicasting”. One possible way to achieve

Multicasting is to reserve one bit to indicate multicasting and the remaining (n-1) address bits contain group number. Each machine can subscribe to any or all of the groups.

Broadcast networks are easily configured for geographically localised networks. Broadcast networks may be Static or dynamic, depending on how the channel is allocated.

In Static allocation, time is divided into discrete intervals and using round robin method, each machine is allowed to broadcast only when its time slot comes up. This method is inefficient because the channel capacity is wasted when a machine has nothing to broadcast during its allocated slot.

Dynamic allocation may be centralised or decentralised. In centralised allocation method, there is a single entity, for example, a bus arbitration unit which determines who goes next and this is achieved by using some internal algorithm. In Decentralised channel allocation method, there is no central entity, here, each machine decides for itself whether or not to transmit.

The different types of Broadcast networks are:

1. Packet Radio Networks.
2. Satellite Networks.
3. Local Area Networks.

### **Packet Radio Networks**

These are diverse access mechanism networks in which it is not possible for all nodes to hear the transmission of the other nodes. The broadcasting differs from satellite networks broadcasting in several ways. In particular stations have limited range introducing the need for radio repeaters, which in turn affects the routing, and acknowledges schemes. Also, the propagation delay is much less than for satellite broadcasting.

### **Satellite Networks**

These are made up of unified hubs/switches and thousands of remote devices which sends and receives data, voice and information with the hubs/switches through satellites. In other words, it communicates with satellite dishes on earth by sending and receiving data, voice and information from the orbiting geostationary satellite thousands of kilometres above the equator. Satellite Networks made available cheap, resizable and lofty suitable relay of services that cover large area geographically.

### **LAN (Local Area Network)**

Local Area Network is a computer network that spans over a relatively small area. Most LANs are confined to a single building or group of buildings within a campus. However, one LAN can be connected to other LANs over any distance via telephone

lines and radio waves. A system of LANs connected in this way is called a wide-area network (WAN).

Most LANs connect workstations and personal computers. Each node (individual computer) in a LAN has its own CPU with which it executes programs, but it is also able to access data and devices anywhere on the LAN. This means that many users can share data as well as expensive devices, such as laser printers, fax machines etc. Users can also use the LAN to communicate with each other, by sending e-mail or engaging in chat sessions. There are many different types of LANs, Ethernets being the most common for PCs.

The following characteristics differentiate one LAN from another:

### **1. Topology**

The geometric arrangement of devices on the network. For example, devices can be arranged in a ring or in a straight line.

### **2. Protocols**

The rules and encoding specifications for sending data. The protocols also determine whether the network uses peer-to-peer or client/server architecture.

### **3. Media**

Devices can be connected by twisted-pair wire, coaxial cables, or fibre optic cables. Some networks communicate via radio waves hence, do not use any connecting media.

LANs are capable of transmitting data at very fast rates, much faster than data can be transmitted over a telephone line; but the distances are limited, and there is also a limit on the number of computers that can be attached to a single LAN.

The typical characteristics of a LAN are:

1. Confined to small areas i.e., it connects several devices over a distance of 5 to 10 km.
2. High speed.
3. Most inexpensive equipment.
4. Low error rates.
5. Data and hardware sharing between users owned by the user.
6. Operates at speeds ranging from 10 Mbps to 100 Mbps. Nowadays 1000 Mbps are available.

### **3.3.2 Point-to-Point or Switched Networks**

Point-to-point or switched, networks are those in which there are many connections between individual pairs of machines. In these networks, when a packet travels from source to destination it may have to first visit one or more intermediate machines.

Routing algorithms play an important role in Point-to-point or Switched networks because often multiple routes of different lengths are available.

An example of switched network is the international dial-up telephone system.

The different types of Point- to-point or Switched networks are:

1. Circuit Switched Networks.
2. Packet Switched Networks.

In Switched network, the temporary connection is established from one point to another for either the duration of the session (circuit switching) or for the transmission of one or more packets of data (packet switching).

### **Circuit Switched Networks**

Circuit Switched networks use a networking technology that provides a temporary, but dedicated connection between two stations no matter how many switching devices are used in the data transfer route. Circuit switching was originally developed for the analogue based telephone system in order to guarantee steady and consistent service for two people engaged in a phone conversation. Analogue circuit switching has given way to digital circuit switching, and the digital counterpart still maintains the connection until broken (one side hangs up). This means bandwidth is continuously reserved and “silence is transmitted” just the same as digital audio in voice conversation.

### **Packet Switched Networks**

Packet switched Networks use a networking technology that breaks up a message into smaller packets for transmission and switches them to their required destination. Unlike circuit switching, which requires a constant point-to-point circuit to be established, each packet in a packet- switched network contains a destination address. Thus, all packets in a single message do not have to travel the same path. They can be dynamically routed over the network as lines become available or unavailable. The destination computer reassembles the packets back into their proper sequence.

Packet switching efficiently handles messages of different lengths and priorities. By accounting for packets sent, a public network can charge customers for only the data they transmit. Packet switching has been widely used for data, but not for real-time voice and video. However, this is beginning to change. IP and **Asynchronous Transfer Mode (ATM)** technologies are expected to enable packet switching to be used for everything.

The first international standard for wide area packet switching networks was X.25, which was defined when all circuits were digitized and susceptible to noise. Subsequent technologies, such as frame relay and **Switch Multimegabit Data Service (SMDS)** were designed for today’s almost-error-free digital lines.

ATM uses a cell-switching technology that provides the bandwidth sharing efficiency of packet switching with the guaranteed bandwidth of circuit switching.

Higher-level protocols, such as TCPIP, IPX/SPX and NetBIOS, are also packet based and are designed to ride over packet-switched topologies.

Public packet switching networks may provide value added services, such as protocol conversion and electronic mail.



### **SELF ASSESSMENT EXERCISE 1**

1. Explain the difference between Client/Server and Peer-to-peer architecture?
2. List the important aspects that should be kept in mind while designing a network?
3. Write briefly about the areas where networks are used?
4. Differentiate between Broadcast and point-to-point networks.

## **3.4 Network Topology**

Topology refers to the shape of a network, or the network's layout. How different nodes in a network are connected to each other and how they communicate with each other is determined by the network's topology. Topologies are either physical or logical. **In other words, it is the physical and logical arrangement of network, that is, the physical and logical mapping of a network.**

Some of the most common network topologies are:

1. Bus topology
2. Ring topology
3. Star topology
4. Mesh topology
5. Tree topology and
6. Cellular topology

The parameters that are to be considered while selecting a physical topology are:

1. Ease of installation.
2. Ease of reconfiguration.
3. Ease of troubleshooting.

### **3.4.1 Bus Topology**

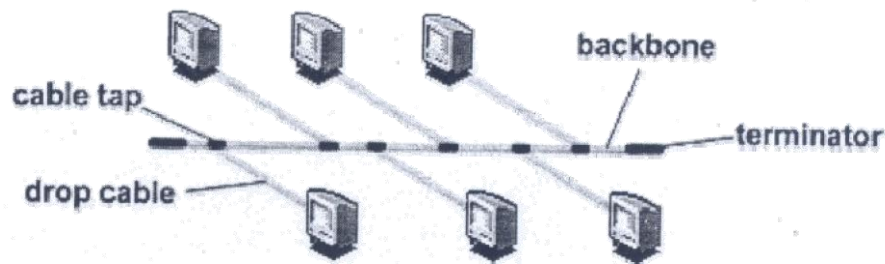

Figure 1.2: Bus topology

In Bus topology, all devices are connected to a central cable, called the bus or backbone. The bus topology connects workstations using a single cable. Each workstation is connected to the next workstation in a point-to-point fashion. All workstations connect to the same cable. Figure 1.2 shows computers connected using Bus Topology.

In this type of topology, if one workstation goes faulty all workstations may be affected as all workstations share the same cable for the sending and receiving of information. The cabling cost of bus systems is the least of all the different topologies. Each end of the cable is terminated using a special terminator.

The common implementation of this topology is Ethernet. Here, message transmitted by one workstation is heard by all the other workstations.

### Advantages of Bus Topology

1. Installation is easy and cheap when compared to other topologies
2. Connections are simple and this topology is easy to use.
3. Less cabling is required.
4. The breakdown of one computer in the network does not affect the other computer

### Disadvantages of Bus Topology

1. Used only in comparatively small networks.
2. The breakdown of the backbone cable can cause the breakdown of the whole system
3. As all computers share the same bus, the performance of the network deteriorates when we increase the number of computers beyond a certain limit.
4. Fault identification is difficult.
5. Improper termination of the backbone can cause the system not to function well.
6. A single fault in the cable stops all transmission.

### 3.4.2 Star Topology

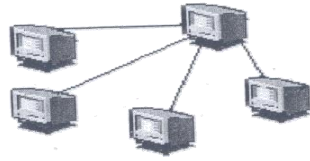

Figure 1.3: Star topology

Star topology uses a central hub through which, all components are connected. In a Star topology, the central hub is the host computer, and at the end of each connection is a terminal as shown in Figure 1.3.

Nodes communicate across the network by passing data through the hub. A star network uses a significant amount of cable as each terminal is wired back to the central hub, even if two terminals are side by side but several hundred meters away from the host. The central hub makes all routing decisions, and all other workstations can be simple.

An advantage of the star topology is, that failure, in one of the terminals does not affect any other terminal; however, failure of the central hub affects all terminals. This type of topology is frequently used to connect terminals to a large time-sharing host computer.

#### Advantages of Star Topology

1. Installation and configuration of network is easy.
2. Less expensive when compared to mesh topology.
3. Faults in the network can be easily traced.
4. Expansion and modification of star network is easy.
5. Single computer failure does not affect the network.
6. Supports multiple cable types like shielded twisted pair cable, unshielded twisted pair cable, ordinary telephone cable etc.

#### Disadvantages of Star Topology

1. Failure in the central hub brings the entire network to a halt.
2. More cabling is required in comparison to tree or bus topology because each node is connected to the central hub.
3. **The cost of installation is high due to the cost of the hub**

### 3.4.3 Ring Topology

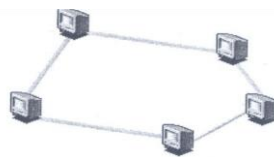

Figure 1.4: Ring Topology



In Ring Topology all devices are connected to one another in the shape of a closed loop, so that each device is connected directly to two other devices, one on either side of it, i.e., the ring topology connects workstations in a closed loop, which is depicted in **Figure 1.4**. Each terminal is connected to two other terminals (the next and the previous), with the last terminal being connected to the first. Data is transmitted around the ring in one direction only; each station passing on the data to the next station till it reaches its destination.

Information travels around the ring from one workstation to the next. Each packet of data sent on the ring is prefixed by the address of the station to which it is being sent. When a packet of data arrives, the workstation checks to see if the packet address is the same as its own, if it is, it grabs the data in the packet. If the packet does not belong to it, it sends the packet to the next workstation in the ring.

Faulty workstations can be isolated from the ring. When the workstation is powered on, it connects itself to the ring. When power is off, it disconnects itself from the ring and allows the information to bypass the workstation.

The common implementation of this topology is token ring. A break in the ring causes the entire network to fail. Individual workstations can be isolated from the ring.

### **Advantages of Ring Topology**

1. Easy to install and modify the network.
2. Fault isolation is simplified.
3. Unlike Bus topology, there is no signal loss in Ring topology because the tokens are data packets that are re-generated at each node.

### **Disadvantages of Ring Topology**

1. Adding or removing computers disrupts the entire network.
2. break in the ring can stop the transmission in the entire network.
3. Finding fault is difficult.
4. Expensive when compared to other topologies.

### **3.4.4 Tree Topology**

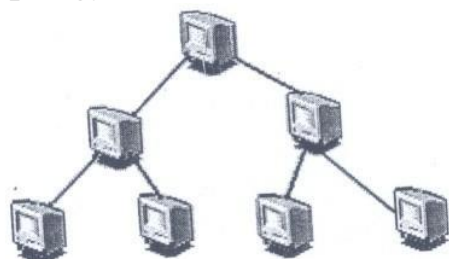

**Figure 1.5:** Tree Topology

Tree topology is a LAN topology in which only one route exists between any two nodes on the network. The pattern of connection resembles a tree in which all

branches spring from one root. **Figure 1.5** shows computers connected using Tree Topology. **This type of topology is also called hierarchical topology.**

Tree topology is a hybrid topology, it is similar to the star topology but the nodes are connected to the secondary hub **or switch**, which in turn is connected to the central hub **or switch**. In this topology groups of star-configured networks are connected to a linear bus backbone.

### Advantages of Tree Topology

1. Installation and configuration of network is easy.
2. Less expensive when compared to mesh topology.
3. Faults in the network can be detected traced.
4. The addition of the secondary hub allows more devices to be attached to the central hub.
5. Supports multiple cable types like shielded twisted pair cable, unshielded twisted pair cable, ordinary telephone cable etc.

### Disadvantages of Tree Topology

1. Failure in the central hub brings the entire network to a halt.
2. More cabling is required when compared to bus topology because each node is connected to the central hub.

### 3.4.5 Mesh Topology

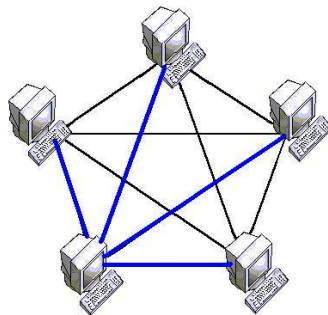

**Figure 1.6:** Mesh Topology

Devices are connected with many redundant interconnections between network nodes. In a well-connected topology, every node has a connection to every other node in the network. The cable requirements are high, but there are redundant paths built in. Failure in one of the computers does not cause the network to break down, as they have alternative paths to other computers.

Mesh topologies are used in critical connection of host computers (typically telephone exchanges). Alternate paths allow each computer to balance the load to other computer systems in the network by using more than one of the connection paths available. A fully connected mesh **topology with n devices has  $n(n-1)$  simplex links and  $n(n-1)/2$  duplex links. The total number of inputs/outputs in n devices is  $(n-1)$ .**

### Advantages of Mesh Topology

1. Use of dedicated links eliminates traffic problems.
2. Failure in one of the computers does not affect the entire network.
3. Point-to-point link makes fault isolation easy.
4. It is robust.
5. Privacy between computers is maintained as messages travel along dedicated path.

### Disadvantages of Mesh Topology

1. The amount of cabling required is high.
2. A large number of I/O (input/output) ports are required.

### 3.4.6 Cellular Topology

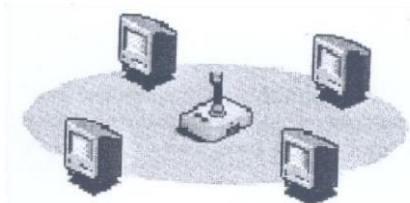

Figure 1.7: Cellular Topology

Cellular topology, divides the area being serviced into cells. In wireless media each point transmits in a certain geographical area called a cell, each cell represents a portion of the total network area. Figure 1.7 shows computers using Cellular Topology. Devices that are present within the cell, communicate through a central hub/switches. Hubs/switches in different cells are interconnected and hubs/switches are responsible for routing data across the network. They provide a complete network infrastructure. Cellular topology is applicable only in case of wireless media that does not require cable connection.

### Advantages of Cellular Topology

1. If the hubs maintain a point-to-point link with devices, trouble shooting is easy.
2. Hub-to-hub fault tracking is more complicated, but allows simple fault isolation.

### Disadvantages of Cellular Topology

When a hub/switch fails, all devices serviced by the hub/switch lose service (are affected).



### SELF ASSESSMENT EXERCISE 2

1. List the importance of using computer networks in Airline and Railway reservation systems?

2. What are the various types of networks??
3. Compare Tree topology with Star topology.
4. Suppose we have~ to add new nodes to the network, then which is the best suited topology and why?

### **3.5 Applications of Network**

Computer networks are used as a highly reliable medium for exchange of information. Using a computer network, we can do virtually everything that a Mainframe or a Minicomputer can do, but at a much lower cost.

There are numerous applications of computer networks, some of them are:

1. Share resources and information.
2. Access to remote information.
3. Person-to-person communication.
4. Interactive entertainment.

#### **3.5.1 Share Resources and Information**

Using a Computer network, we can share expensive resources such as laser printers, CD-ROM Drives, Fax machines etc. We can share information and many persons can work together on projects and tasks that require co-ordination and communication, even though these users may not be physically close.

#### **3.5.2 Access to Remote Information**

Access to remote information involves interaction between a person and a remote database. Financial Institutions allow access to their information so that people can pay their bills, handle their investments and manage their bank accounts electronically. Online shopping also allows people, access to product information before purchasing the product.

These days, many newspapers and digital libraries are available online and allow users to access news and information which is of interest to them. Another application is the World Wide Web, which contains information about a wide variety of subjects like health, sports, science, recreation, history, government etc.

#### **Person-to-person Communication**

Person-to-person communication is mostly carried out using e-mail (Electronic mail) Electronic mail is a simple, yet potent facility. E-mail is more valuable and useful than the telephone because by using e-mail we can convey information that is difficult or impossible to read over the telephone, like reports, tables, charts, images etc. Using a computer network, it is also possible to **organise** virtual meeting among people who are far away from each other and this is called video conferencing.

Virtual meetings have other applications such as in Distance education, getting medical opinions from distant specialists (remote diagnosis) etc. Multimedia communication can also be used for tele training. **COVID-19 has made virtual reality (such as video conferencing, teleconferencing and telepresence) a new normal for almost all activities of men.**

### **Interactive Entertainment**

Computer Networks such as Internet offer a wide variety of entertainment, there are many companies online, which offer video-on-demand. A large variety of multi-person real-time simulation games, like hide-and seek in a virtual dungeon and flight simulators with the players in one team trying to shoot down the players in the opposite team and many such games are available on-line.

### **3.6 Networking Model**

Most of the networks today are **organised** as a series of stacked layers with each layer stacked over another layer below it. This is done in order to divide the workload and to simplify the systems design. The architecture is considered scalable if it is able to accommodate a number of layers in either large or small scales. For example, a computer that runs an Internet application may require all of the layers that were defined for the architectural model. Similarly, a computer that acts as a router may not need all these layers. Systems design is furthermore simplified because with a layered architecture, the design has to only concern the layer in question and not worry about the architecture in a macro sense.

The depth and functionality of this stack differs from network to network. However, regardless of the differences among all networks, the purpose of each layer is to provide certain services (job responsibilities) to the layer above it, shielding the upper layers from the intricate details of how the services offered are implemented.

Every computer in a network possesses within it a generic stack. A logical communication may exist between any two computers through the layers of the same “level”. Layer-n on one computer may converse with layer-n on another computer **as shown in Figure 1.8**. There are rules and conventions used in the communication at any given layers, which are known collectively as the layer-n *protocol* for the nth layer.

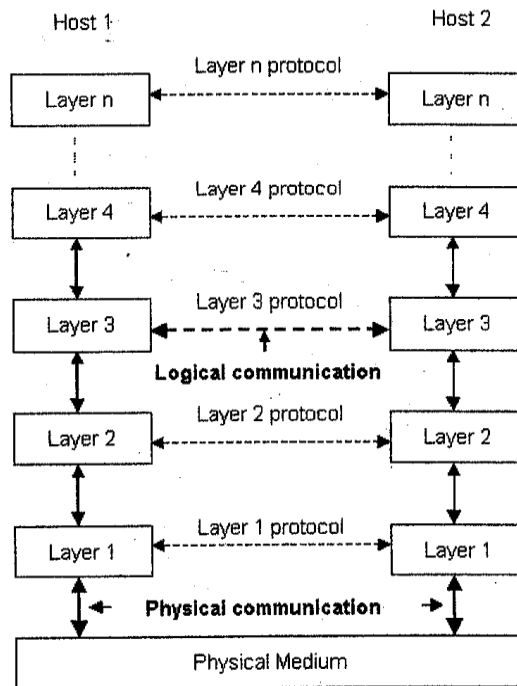

**Figure 1.8:** Layered network architecture

Data are not directly transferred from layer-n on one computer to layer-n on another computer. Rather, each layer passes data and control information to the layer directly below until the lowest layer is reached. Below layer-1 (the bottom layer), is the physical medium (the hardware) through which the actual transaction takes place. In **Figure 1.8** logical communication is shown by a broken-line arrow and physical communication by a solid-line arrow.

Between every pair of adjacent layers is an interface. The interface is a specification that determines how the data should be passed between the layers. **It** defines what primitive operations and services the lower layer should offer to the upper layer. One of the most important considerations when designing a network is to design clean-cut interfaces between the layers. To create such an interface between the layers would require each layer to perform a specific collection of well-understood functions. A clean-cut interface makes it easier to replace the implementation of one layer with another implementation because all that is required of the new implementation is that, it offers, exactly the same set of services to its neighbouring layer above as the old implementation did.

### 3.6.1 OSI References Model

7	APPLICATION LAYER 18
---	-------------------------

6	PRESENTATION LAYER
5	SESSION LAYER
4	TRANSPORT LAYER
3	NETWORK LAYER
2	DATA LINK LAYER
1	PHYSICAL LAYER

**Figure 1.9:** Layers of OSI Reference Model

The Open System Interconnection (OSI) model is a set of protocols that attempt to define and **standardise** the data communications process; we can say that it is a concept that describes how data communications should take place.

The OSI model was set by the International Standards Organisation (ISO) in 1984, and it is now considered the primary architectural model for inter-computer communications. The OSI model has the support of most major computer and network vendors, many large customers, and most governments in different countries.

The Open Systems Interconnection (OSI) reference model describes how information from a software application in one computer moves through a network medium to a software application in another computer. The OSI reference model is a conceptual model composed of seven layers as shown in Figure 9 each specifying particular network functions and into these layers are fitted the protocol standards developed by the ISO and other standards bodies. The OSI model divides the tasks involved with moving information between networked computers into seven smaller, more manageable task groups. A task or group of tasks is then assigned to each of the seven OSI layers. Each layer is reasonably self-contained so that the tasks assigned to each layer can be implemented independently. This enables the solutions offered by one layer to be updated without affecting the other layers.

The OSI model is modular. Each successive layer of the OSI model works with the one above and below it.

Although, each layer of the OSI model provides its own set of functions, it is possible to group the layers into two distinct categories. The first four layers i.e., physical, data link, network, and transport layer provide the end-to-end services necessary for the transfer of data between two systems. These layers **provide** the protocols associated with the communications network used to link two computers together. Together, these are communication oriented.

The top three layers i.e., the application, presentation, and session layers provide the application services required for the exchange of information. That is, they

allow two applications, each running on a different node of the network to interact with each other through the services provided by their respective operating systems. Together, these are data processing oriented.

The following are the seven layers of the Open System Interconnection (OSI) reference model:

Layer 7 -Application layer

Layer 6 -Presentation layer

Layer 5 -Session layer

Layer 4 -Transport layer

Layer 3 -Network layer

Layer 2 -Data Link layer

Layer I -Physical layer

### **Application Layer (Layer 7)**

The Application layer is probably the most easily misunderstood layer of the model. This top layer defines the language and syntax that programs use to communicate with other programs. The application layer represents the purpose of communicating in the first place. For example, a program in a client workstation uses commands to request data from a program in the server. Common functions at this layer are opening, closing, reading and writing files, transferring files and e-mail messages, executing remote jobs and obtaining directory information about network resources etc.

### **Presentation Layer (Layer 6)**

The Presentation layer performs code conversion and data reformatting (syntax translation). It is the translator of the network; it makes sure the data is in the correct form for the receiving application.

When data are transmitted between different types of computer systems, the presentation layer negotiates and manages the way data are represented and encoded. For example, it provides a common denominator between ASCII and EBCDIC machines as well as between different floating point and binary formats. Sun's XDR and OSI's ASN. 1 are two protocols used for this purpose. This layer is also used for encryption and decryption. It also provides security features through encryption and decryption.

### **Session Layer (Layer 5)**



The Session layer decides when to turn communication on and off between two computers. It provides the mechanism that controls the data-exchange process and coordinates the interaction (communication) between them in an orderly manner.

It sets up and clears communication channels between two communicating components. It determines one-way or two-way communications and manages the dialogue between both parties; for example, making sure that the previous request has been fulfilled before the next one is sent. It also marks significant parts of the transmitted data with checkpoints to allow for fast recovery in the event of a connection failure.

#### **Transport Layer (Layer 4)**

The transport layer is responsible for overall end-to-end validity and integrity of the transmission i.e., it ensures that data is successfully sent and received between two computers. The lower data link layer (layer 2) is only responsible for delivering packets from one node to another.

Thus, if a packet gets lost in a router somewhere in the enterprise Internet, the transport layer will detect that. It ensures that if a 12MB file is sent, the full 12MB is received.

If data is sent incorrectly, this layer has the responsibility of asking for retransmission of the data. Specifically, it provides a network-independent, reliable message-independent, reliable message-interchange service to the top three application-oriented layers. This layer acts as an interface between the bottom and top three layers. By providing the session layer (layer 5) with a reliable message transfer service, it hides the detailed operation of the underlying network from the session layer.

#### **Network Layer (Layer 3)**

The network layer establishes the route between the sending and receiving stations. The unit of data at the network layer is called a packet. It provides network routing and flow and congestion functions across computer-network interface.

It makes a decision as to where to route the packet based on information and calculations from other routers, or according to static entries in the routing table. It examines network addresses in the data instead of physical addresses seen in the Data Link layer.

The Network layer establishes, maintains, and terminates logical and/or physical connections.

The network layer is responsible for translating logical addresses, or names, into physical addresses.

The main device found at the Network layer is a router.

#### **Data link Layer (Layer 2)**

The data link layer groups the bits that we see on the Physical layer into Frames. It is primarily responsible for error-free delivery of data on a hop. The Data link layer is split into two sub-layers i.e., the Logical Link Control (LLC) and Media Access Control (MAC).

The Data-Link layer handles the physical transfer, framing (the assembly of data into a single unit or block), flow control and error- Control functions (and retransmission in the event of an error) over a single transmission link; it is responsible for getting the data packaged and onto the network cable. The data link layer provides the network layer (layer 3) reliable information-transfer capabilities.

The main network device found at the Datalink layer is a bridge. This device works at a higher layer than the repeater and therefore is a more complex device. It has some understanding of the data it receives and can make a decision based on the frames it receives as to whether it needs to let the information pass, or can remove the information from the network. This means that the amount of traffic on the medium can be reduced and therefore, the usable bandwidth can be increased.

### **Physical Layer (Layer 1)**

The data units on this layer are called bits. This layer defines the mechanical and electrical definition of the network medium (cable) and network hardware. This includes how data is impressed onto the cable and retrieved from it.

The physical layer is responsible for passing bits onto and receiving them from the connecting medium. This layer gives the data-link layer (layer 2) its ability to transport a stream of serial data bits between two communicating systems; it conveys the bits that moves along the cable. It is responsible for ensuring that the raw bits get from one place to another, no matter what shape they are in, and deals with the mechanical and electrical characteristics of the cable.

This layer has no understanding of the meaning of the bits, but deals with the electrical and mechanical characteristics of the signals and signalling methods.

The main network device found in the Physical layer is a **repeater**. The purpose of a repeater (as the name suggests) is simply to receive the digital signal, reform it, and retransmit the signal. This has the effect of increasing the maximum length of a network, which would not be possible due to signal deterioration if, a repeater were not available. The repeater, simply regenerates cleaner digital signal so it doesn't have to understand anything about the information it is transmitting, and processing on the repeater.

An example of the Physical layer is RS-232.

Each layer, with the exception of the physical layer, adds information to the data as it travels from the Application layer down to the physical layer. This extra information is called a header. The physical layer does not append a header to information because it is concerned with sending and receiving information on the individual bit level.

We see that the data for each layer consists of the header and data of the next higher layer. Because the data format is different at each layer, different terms are commonly used to name the data package at each level. **Figure 1.10 summarises** these terms layer by layer.

LAYER	DATA PACKAGE NAME
Application Layer	Application Protocol Data Unit
Presentation Layer	Presentation Protocol Data Unit. Generic name is Protocol Data Unit (PDU). For example, at session layer it is S-PDU.
Session Layer	Session Protocol Data Unit
Transport Layer	Segment, Transport Protocol Data Unit (TPDU)
Network Layer	Datagram, packet
Data link Layer	Frame
Physical Layer	Bit

**Figure 1.10:** Data package names in the OSI reference model

## OSI Protocols

The OSI model provides a conceptual framework for communication between computers, but the model itself is not a method of communication. Actual communication is made possible by using communication protocols. In the context of data networking, a *protocol* is a formal set of rules and conventions that governs how computers exchange information over a network medium. A protocol implements the functions of one or more of the OSI layers. A wide variety of communication protocols exist, but all tend to fall into one of the following groups: *LAN protocols*, *WAN protocols*, *network protocols*, and *routing protocols*. *LAN protocols* operate at the network and data link layers of the OSI model and define communication over the various LAN media. *WAN protocols* operate at the lowest three layers of the OSI model and define communication over the various wide-area media. *Routing protocols* are network-layer protocols that are responsible for path determination and traffic switching. Finally, *network protocols* are the various upper-layer protocols that exist in a given protocol suite.

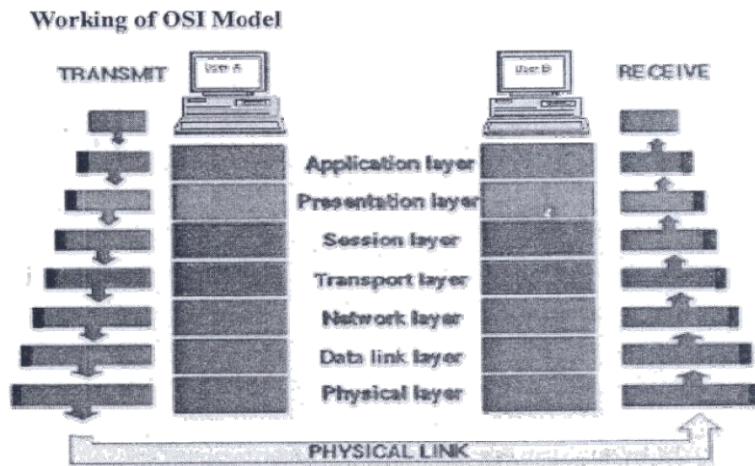

Figure 1.11: Working of OSI Reference Model

Information being transferred from a software application in one computer system to software application in another must pass through each of the OSI layers. Each layer communicates with three other OSI layers i.e., the layer directly above it, the layer directly below it, and its peer layer in other networked systems. If, for example, in Figure 1.11, a software application in System A has information to transmit to a software application in System B, the application program in System A will pass its information to the application layer (Layer 7) of System A. The application layer then passes the information to the presentation layer (Layer 6); the presentation layer reformats the data if required such that B can understand it. The formatted data is passed to the session layer (Layer 5), which in turn requests for connection establishment between session layers of A and B, it then passes the data to the transport layer. The transport layer breaks the data into smaller units called segments and sends them to the Network layer. The Network layer selects the route for transmission and if, required breaks the data packets further. These data packets are then sent to the Data link layer that is responsible for encapsulating the data packets into data frames. The Data link layer also adds source and destination addresses with error checks to each frame, for the hop.

The data frames are finally transmitted to the physical layer. In the physical layer, the data is in the form of a stream of bits and this is placed on the physical network medium and is sent across the medium to System B.

B receives the bits at its physical layer and passes them on to the Data link layer, which verifies that no error has occurred. The Network layer ensures that the route selected for transmission is reliable, and passes the data to the Transport layer. The function of the Transport layer is to reassemble the data packets into the file being transferred and then, pass it on to the session layer. The session layer confirms that the transfer is complete, and if so, the session is terminated.

The data is then passed to the Presentation layer, which may or may not reformat it to suit the environment of B and sends it to the Application layer. Finally, the Application layer of System B passes the information to the recipient Application program to complete the communication process.

## Interaction between different layers of OSI model

A given layer in the OSI layers generally communicates with three other OSI layers: the layer directly above it, the layer directly below it, and its Peer layer in another networked computer system. The data link layer in System A, for example, communicates with the network layer of System A, the physical layer of System A, and the data link layer in System B.

## Services provided by OSI layers

One OSI layer communicates with another layer to make use of the services provided by the second layer. The services provided by adjacent layers help a given OSI layer communicate with its peer layer in other computer systems. Three basic elements are involved in layer services: the service user, the service provider, and the service access point (SAP).

In this context, the service user is the OSI layer that requests services from an adjacent OSI layer. The service *provider* is the OSI layer that provides services to service users. OSI layers can provide services to multiple service users. The *SAP* is a conceptual location at which one OSI layer can request the services of another OSI layer.

## OSI Model Layers and Information Exchange

The seven OSI layers use various forms of control information to communicate with their peer layers in other computer systems. This control information consists of specific requests and instructions that are exchanged between peer OSI layers.

Control information typically takes one of two forms: headers and trailers. Headers are prepended to data that has been passed down from upper layers. Trailers are appended to data that has been passed down from upper layers.

Headers, trailers, and data are relative concepts, depending on the layer that analyses the information unit. At the network layer, an information unit, for example, consists of a Layer 3 header and data. At the data link layer, however, all the information passed down by the network layer (the Layer 3 header and the data) is treated as data. In other words, the data portion of an information unit at a given OSI layer potentially can contain headers, trailers, and data from all the higher layers. This is known as encapsulation.

### 3.6.2 TCP/IP Reference Model

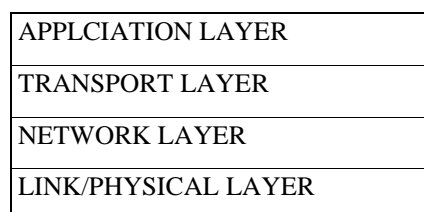

Figure 1.12: Layers of TCP/IP reference model

TCP/IP stands for Transmission Control Protocol/Internet Protocol. It is a protocol suite used by most communications' software. TCP/IP is a robust and proven technology that was first tested in the early 1980s on ARPA Net, the U.S. military's Advanced Research Projects Agency network, and the world's first packet-switched network. TCP/IP was designed as an open protocol that would enable all types of computers to transmit data to each other via a common communications language.

TCP/IP is a layered protocol similar to the ones used in all the other major networking architectures, including IBM's SNA, Windows' NetBIOS, Apple's AppleTalk, Novell's NetWare and Digital's DECnet. The different layers of the TCP/IP reference model are shown in [Figure 1.12](#). Layering means that after an application initiates the communications, the message (data) to be transmitted is passed through a number of stages or layers until it actually moves out onto the wire. The data are packaged with a different header at each layer. At the receiving end, the corresponding programs at each protocol layer unpack the data, moving it "back up the stack" to the receiving application.

TCP/IP is composed of two major parts: TCP (Transmission Control Protocol) at the transport layer and IP (Internet Protocol) at the network layer. TCP is a connection-oriented protocol that passes its data to IP, which is a connectionless one. TCP sets up a connection at both ends and guarantees reliable delivery of the full message sent. TCP tests for errors and requests retransmission if necessary, because IP does not.

An alternative protocol to TCP within the TCP/IP suite is UDP (User Datagram Protocol), which does not guarantee delivery. Like IP, it is also connectionless, but very useful for real-time voice and video, where it doesn't matter if a few packets get lost.

## **Layers of TCP/IP reference model**

### **Application Layer (Layer 4)**

The top layer of the protocol stack is the application layer. It refers to the programs that initiate communication in the first place. TCP/IP includes several application layer protocols for mail, file transfer, remote access, authentication and name resolution.

These protocols are embodied in programs that operate at the top layer just as any custom-made or packaged client/server application would.

There are many Application Layer protocols and new protocols are always being developed.

The most widely known Application Layer protocols are those used for the exchange of user information, some of them are:

**The Hypertext Transfer Protocol (HTTP)** is used to transfer files that make up the Web pages of the World Wide Web.

**The File Transfer Protocol (FTP)** is used for interactive file transfer.

**The Simple Mail Transfer Protocol (SMTP)** is used for the transfer of mail messages and attachments.

The post office protocol 3 (POP3) is used to retrieve email from remote email server to local server to a local email client through port 110. SMTP is the protocol used in sending the email to the POP3.

**Telnet**, is a terminal emulation protocol, and, is used for remote login to network hosts.

Other Application Layer protocols that help in the management of TCP/IP networks are:

**The Domain Name System (DNS)**, which, is used to resolve a host name to an IP address.

**The Simple Network Management Protocol (SNMP)** which is used between network management consoles and network devices (routers, bridges, and intelligent hubs/switches) to collect and exchange network management information.

Examples of Application Layer interfaces for TCP/IP applications are Windows Sockets and NetBIOS. Windows Sockets provides a standard application-programming interface (API) under the Microsoft Windows operating system. NetBIOS is an industry standard interface for accessing protocol services such as sessions, datagrams, and name resolution.

### **Transport Layer (Layer 3)**

The Transport Layer (also known as the Host-to-Host Transport Layer) is responsible for providing the Application Layer with session and datagram communication services.

TCP/IP does not contain Presentation and Session layers, the services are performed if required, but they are not part of the formal TCP/IP stack. For example, Layer 6 (Presentation Layer) is where data conversion (ASCII to EBCDIC, floating point to binary, etc.) and encryption/decryption is performed, Layer 5 is the Session Layer, which is performed in layer 4 in TCP/IP, Thus, we jump from layer 7 of OS I down to layer 4 of TCP/IP.

From Application to Transport Layer, the application delivers its data to the communications system by passing a Stream of data bytes to the transport layer along with the socket of the destination machine.

The core protocols of the Transport Layer are TCP and the User Datagram Protocol (UDP).

**TCP:** TCP provides a one-to-one, connection-oriented, reliable communications service. TCP is responsible for the establishment of a TCP



connection, the sequencing and acknowledgment of packets sent, and the recovery of packets lost during transmission.

**UDP:** UDP provides a one-to-one or one-to-many, connectionless, unreliable communications service. UDP is used when the amount of data to be transferred is small (such as the data that would fit into a single packet), when the overhead of establishing a TCP connection is not desired, or when the applications or upper layer protocols provide reliable delivery.

The transport Layer encompasses the responsibilities of the OSI Transport Layer and some of the responsibilities of the OSI Session Layer.

## **Internet Layer (Layer 2)**

The internet layer handles the transfer of information across multiple networks through the use of gateways and routers. The internet layer corresponds to the part of the **OSI** network layer that is concerned with the transfer of packets between machines that are connected to different networks. It deals with the routing of packets across these networks as well as with the control of congestion. A key aspect of the internet layer is the definition of globally unique addresses for machines that are attached to the Internet.

The Internet layer provides a single service namely, best-effort connectionless packet transfer. IP packets are exchanged between routers without a connection setup; the packets are 'touted independently and so they may traverse different paths. For this reason, IP packets are also called datagrams. The connectionless approach makes the system robust; that is, if failures occur in the network, the packets are routed around the points of failure; hence, there is no need to set up connections. The gateways that interconnect the intermediate networks may discard packets when congestion occurs. The responsibility for recovery from these losses is **based** on to the Transport Layer. The core protocols of the Internet Layer are IP, ARP, ICMP, and IGMP.

**The Internet Protocol (IP)** is a routable protocol responsible for IP addressing and the fragmentation and reassembly of packets.

**The Address Resolution Protocol (ARP)** is responsible for the resolution of the Internet Layer address to the Network Interface Layer address, such as a hardware address.

**The Internet Control Message Protocol (ICMP)** is responsible for providing diagnostic functions and reporting errors or conditions regarding the delivery of IP packets.

**The Internet Group Management Protocol (IGMP)** is responsible for the management of IP multicast groups.

The Internet Layer is analogueous to the Network layer of the OSI model.

## **Link/Physical Layer (Layer I)**



The Link/Physical Layer (also called the Network Access Layer) is responsible for placing TCP/IP packets on the network medium and receiving TCP/IP packets of the network medium. TCP/IP was designed to be independent of the network access method, frame format, and medium. In this way, TCP/IP can be used to connect differing network types. This includes LAN technologies such as Ethernet or Token Ring and WAN technologies such as X.25 or Frame Relay. Independence from any specific network technology gives TCP/IP the ability to be adapted to new technologies such as Asynchronous Transfer Mode (ATM).

The Network Interface Layer encompasses the Data Link and Physical layers of the OSI Model. Note, that the Internet Layer does not take advantage of sequencing and acknowledgement services that may be present in the Data Link Layer. An unreliable Network Interface Layer is assumed, and reliable communications through session establishment and the sequencing and acknowledgement of packets is the responsibility of the Transport Layer.

### Comparison between OSI and TCP/IP reference model

OSI Reference Model		TCP/IP Protocol Suite				
Layer	Function	Protocol				
1	Application	Telnet	FTP	TFTP	SMTP	DNS
2	Presentation					Others
3	Session	TCP		UDP		
4	Transport					
5	Network	IP	ICMP		ARP	RARP
6	Datalink	Ethernet		TokenRing	Other	
7	Physical					

Figure 1.13: Comparison between OSI and TCP/IP reference model

Both OSI and TCP/IP reference models are based on the concept of a stack of protocols. The functionality of the layers is almost similar. In both models, the layers are there to provide an end-to-end network-independent transport service to processes wishing to communicate with each other.

The Two models have many differences. An obvious difference between the two models is the number of layers: the OSI model has seven layers and the TCP/IP has

four layers. Both have (inter) network, transport, and application layers, but the other layers are different. OSI uses strict layering, resulting in vertical layers whereas TCP/IP uses loose layering resulting in horizontal layers. The OSI model supports both connection less and connection-oriented communication in the network layer, but only connection-oriented communication at the transport layer. The TCP/IP model has only one mode in network layer (connectionless), but supports both modes in the transport layer. With the TCP/IP model, replacing IP by a substantially different protocol would be virtually impossible, thus, defeating one of the main purposes of having layered protocols in the first place.

The OSI reference model was devised before the OSI protocols were designed. The OSI model was not biased toward one particular set of protocols, which made it quite general. The drawback of this ordering is that the designers did not have much experience with the subject, and did not have a good idea of the type of functionality to put in a layer. With TCP/IP the reverse was true: the protocols came first and the model was really just a description of the existing protocols. There was no problem with the protocols fitting the model. The only drawback was that the model did not fit any other protocol stacks.

Figure 1.14 summarizes the basic differences between OSI and TCP/IP reference models.

OSI MODEL	TCP/IP MODEL
Contains 7 Layers	Contains 4 Layers
Uses Strict Layering resulting in vertical layers.	Uses Loose Layering resulting in horizontal layers.
Supports both connectionless & connection-oriented communication in the Network layer, but only connection-oriented communication in Transport Layer	Supports only connectionless communication in the Network layer, but both connectionless & connection-oriented communication in Transport Layer
It distinguishes between Service, Interface and Protocol.	Does not clearly distinguish between Service, Interface and Protocol.
Protocols are better hidden and can be replaced relatively easily as technology changes (No transparency)	Protocols are not hidden and thus cannot be replaced easily. (Transparency) Replacing IP by a substantially different protocol would be virtually impossible
OSI reference model was devised before the corresponding protocols were designed.	The protocols came first and the model was a description of the existing protocols

Figure 1.14: Difference between OSI and TCP/IP reference model

Some of the drawbacks of OS I reference model are:

All layers are not roughly, of equal size and complexity. In practice, the session layer and presentation layer are absent from many existing architectures.

Some functions like addressing, flow control, retransmission **is** duplicated at each layer, resulting in deteriorated performance.

The initial specification of the OSI model ignored the connectionless model, thus, leaving much of the LANs behind.

### Some of the drawbacks of TCP/IP model are:

TCP/IP model does not clearly distinguish between the concepts of service, interface, and protocol.

TCP/IP model is not a general model and therefore it cannot be used to describe any protocol other than TCP/IP.

TCP/IP model does not distinguish or even mention the Physical or the Data link layer. A proper model should include both these layers as separate.



### SELF ASSESSMENT EXERCISE 3

1. Give two reasons for using layered protocols.
2. Explain the OSI reference model in detail.
3. Explain the TCP/IP reference **model** in detail.
4. Bring out the differences between TCP and UDP.

## 3.7 Network Architecture

Depending on the architecture used Networks can be classified as Client/Server or Peer-to-Peer Networks.

### 1.8.1 Client/Server Architecture

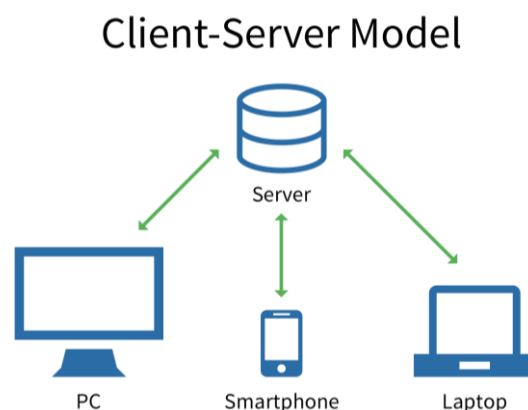

Figure 1.15: Client/Server Architecture

Client/Server Architecture is one in which the client (personal computer or workstation) is the requesting machine and the server is the supplying machine, both

of which are connected via a local area network (LAN) or wide area network (WAN). Since the early 1990s, client/server has been the buzzword for building applications on LANs in contrast to **centralised** minis and mainframes with dedicated terminals. A client/server network is called **Centralised** or Server based network. **Figure 1.15** shows the arrangement of computers in the client/server environment.

The client contains the user interface and may perform some or all of the application processing. Servers can be high-speed microcomputers, minicomputers or even mainframes. A database server maintains the databases and processes requests from the client to extract data from or update the database. An application server provides additional business processing for the clients.

The term client/server is sometimes used to contrast a peer-to-peer network, in which any client can also act as a server. In that case, a client/server entails having a dedicated server.

However, client/server architecture means more than dedicated servers. Simply downloading files from or sharing programs and databases on a server is not true client/server either. True client/server implies that the application was originally designed to run on a network and that the network infrastructure provides the same quality of service as traditional mini and mainframe information systems. **Figure 1.15** shows the arrangement of computers in the Client/Server system.

The network operating system (NOS) together with the database management system (DBMS) and transaction monitor (TP monitor) are responsible for integrity and security of these types of networks. Some of these products have gone through many client/server versions by now and have finally reached industrial strength.

### **Non-client/server**

In non-client/server architecture, the server is nothing more than a remote disk drive. The user's machine does all the processing. If, many users routinely perform lengthy searches, this can bog down the network, because each client has to pass the entire database over the net. At 1,000 bytes per record, a 10,000 record database requires 10MB of data be transmitted.

### **Two-tier client/server**

Two-tier client/server is really the foundation of client/server. The database processing is done in the server. An SQL request is generated in the client and transmitted to the server. The DBMS searches locally and returns only matching records. If 50 records met the criteria only 50K would be transmitted. This reduces traffic in the LAN.

### **Three-tier client/server**

Many applications lend themselves to **centralised** processing. If, they contain proprietary algorithms, security is improved. Upgrading is also simpler. Sometimes, programs are just too demanding to be placed into every client PC. In three-tier client/server, application processing is performed in one or more servers.

### 3.7.2 Peer-to-Peer Architecture

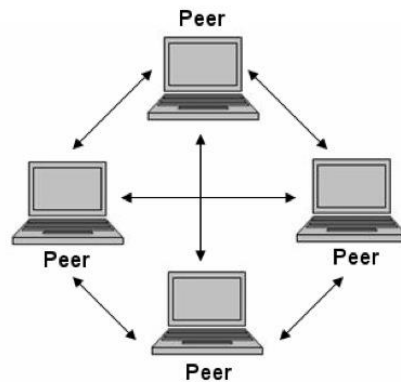

Figure 1.16: Peer-to-peer architecture

A type of network in which each workstation as equal capabilities and responsibilities is called peer-to-peer network. Figure 1.16 shows the arrangement of computers in a peer-to-peer environment. Here each workstation acts as both a client and a server. There is no central repository for information and there is no central server to maintain. Data and resources are distributed throughout the network, and each user is responsible for sharing data and resources connected to their system. This differs from client/server architectures, in which some computers are dedicated to serving the others. Peer-to-peer networks are generally simpler and less expensive, but they usually do not offer the same performance under heavy loads. A peer-to-peer network is also known as a Distributed network.

## 3.8 Example Networks

Nowadays, as computers are extensively used in almost every field, we have many different types of networks. Some of them are public networks, research networks, and co-operative networks, commercial or corporate networks. We can distinguish between different networks on the basis of their history, administration, facilities offered, technical design and the people who use them/user communities). Here we shall discuss some of the popular networks, such as, Novell NetWare, ARPANET, Internet, ATM network etc.

### 3.8.1 Novell Netware

Novell NetWare is the most popular network system in the PC world. Novell NetWare contains the protocols that are necessary to allow communication between different types of PC's and devices. There are several versions of NetWare. The earlier versions NetWare 286 version 2.X was written to run on 286 machines. NetWare 386 versions 3.X were written to run on 386 and 486 machines. The most recent version NetWare 4.X can probably run on almost any type of machine.

Novell Networks are based on the client/server model in which at least one computer functions as a network file server, which runs all of the NetWare protocols and maintains the networks shared data on one or more disk drives. File servers generally allow users on other PC's to access application software or data files i.e., it provides services to other network computers called clients.

There are two types of file servers:

1. Dedicated file servers.
2. Non-dedicated file servers.

### **Dedicated File Servers**

Dedicated file server runs only NetWare and do not run any other software, such as Windows application. Dedicated file servers are mostly used in large networks, because, in large networks, one extra client is less significant and a dedicated server can handle a larger number of requests more efficiently. In large networks, security is one of the major concerns as providing a clear distinction between client and server hardware provides greater security.

### **Non-dedicated File Server**

Non-dedicated file server can run both applications and NetWare. It is useful in small networks because it allows the server to also act as a client and thus, increase the number of clients in the network by one.

There are many other servers within a Novell NetWare such as, Print server, Message server, and Database server.

#### **Print server**

Most of the applications that uses NCP or IPX are legacy packages. However, Microsoft and Novell assist IPX/SPX to communicate as intranet via a firewall through proxy server/industrial standard architecture (ISA) server and boarder manager correspondingly. This gives room for devices using client to have passage to the Internet without installation of TCP/IP locally.

The job of the Print server is to allow users to access shared printers. A Print server manages both requests and printers.

Message server: The job of the Message server is to transfer email messages between a client's PC and a user's mailbox.

Database server: A database server manages database files i.e., it adds, deletes and modifies records in the database; queries the database and generates the result required by the client; and transmits the results back to the client.

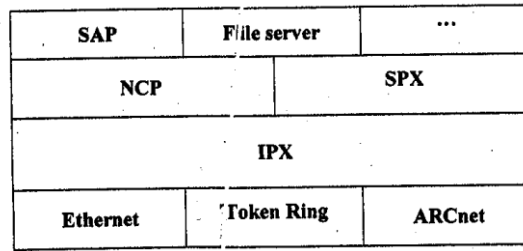

Figure 1.17: The Novell NetWare reference model

NetWare uses a proprietary protocol stack as shown in Figure 1.17. This model is based on the old Xerox Network System, XNS™ but with a lot of modifications.

The Physical and Data link layers can be chosen from various standards that are available, such as, the Ethernet, IBM Token ring, ARCnet.

The Network layer runs an unreliable connectionless internet work protocol called Internet Packet eXchange (IPX). The IPX passes packets transparently from the source to the destination, even if the source and destination are on different networks. The functioning of IPX is similar to IP, except that IPX uses 12-byte addresses instead of 4-byte addresses.

The Transport layer contains a connection-oriented transport protocol called NCP (Network Core Protocol). NCP is the heart of Net-Ware and provides various other services besides user data transport. It defines the type of requests that can be made and how the server responds to the request it eventually receives. The other protocol that is available in the transport layer is SPX (Sequenced Packet eXchange); which provides only transport. TCP is another option. Applications can choose anyone of them, for example, Lotus notes use SPX and File systems uses NCP.

Here, the Session and Presentation layers do not exist. The Application layer contains various application protocols like SAP, File server etc.

### 3.8.2 Arpanet

ARPANET stands for Advanced Research Projects Agency (ARPA) Network. The network was developed in 1969 by ARPA and funded by the Department of Defence (DoD). In the mid-1960s at the height of the cold war, the DoD wanted a command and control network, which could survive the nuclear war. The traditional circuit switched telephone networks were considered too vulnerable, since the loss of one line would certainly terminate all conversations using them and might even partition the network.

The network (ARPANET) was chiefly experimental, and was used to research, develop and test networking technologies. The original network connected four host computers at four separate universities throughout the United States, enabling users to share resources and information. By 1972, there were 37 host computers connected to ARPANET. Also, in that year, ARPA's name was changed to DARPA (Defence Advanced Research Projects Agency). In 1973, ARPANET went beyond the boundaries of the United States by making its first international connection to



England and Norway. One goal of ARPANET was to devise a network that would still be operational, even if, part of the network failed. The research in this area resulted in a set of networking rules or protocols, called TCP/IP (Transmission Control Protocol/Internet Protocol).

TCP/IP is a set of protocols that govern how data is transmitted across networks. It also enables different types of computer operating systems such as DOS and UNIX to share data across a network.

ARPANET functioned as a “backbone” network allowing smaller local networks to connect to the backbone.

Once these smaller networks were connected to the backbone, they were in effect connected to each other.

In 1983, DARPA decided that TCP/IP would be the standard set of protocols used by computers connecting to ARPANET. This meant that any smaller networks (for example, a university network) that wanted to connect to ARPANET also had to use TCP/IP. TCP/IP was available for free and was increasingly used by networks. The spread of TCP/IP helped create the Internet, as we know it today, which is the network of networks that either use the TCP/IP protocols, or can interact with TCP/IP networks.

ARPANET continued to grow, encompassing many networks from universities and government institutions. To help manage this rapidly growing “network of networks”, ARPANET was split into two networks in 1983:

ARPANET continued to be a research and development network.

MILNET an unclassified network reserved only for military sites. MILNET continues to serve this function.

In 1986, a faster backbone network called the NSFNET (National Science Foundation Network) was created. By 1989, there were over 10,000 host computers connected to the Internet.

Because of the success of the NSFNET, plans were made to phase out ARPANET. Many of the sites connected to ARPANET were absorbed by the NSFNET and in 1990 ARPANET was officially dissolved.

### **3.8.3 Internet**

When ARPANET and NSFNET were interconnected the number of networks, machines and users grew exponentially, many regional networks joined up and connections were made across many countries.

The Internet is said to have been “officially” born around 1982 when the different networks (**Because It’s Time Network**(BITNET), **European Academic and Research Network**(EARN), etc.) agreed on using the TCP/IP protocol as a standard for their interconnections making it a network of networks and overcoming some of the previous cacophony of standards, protocols and increasing its coverage.



The word Internet was coined from the word's "interconnection" and "network", Now Internet is the world's largest computer network. It is considered to be the network of networks, and is scattered all over the world. The computers connected to the Internet may communicate with each other using fibre optic cables, telephone lines, satellite links and other media.

The development of Internet is coordinated by a non-profit organisation called the Internet Society (ISOC). Its aim is to spread the use of Internet, keep statistics of its use, helpless developed countries in building their infrastructure and Internet-technology. The Internet Architecture Board (IAB), plans long term trends and keeps a record of the RFC (Request for Comments) documents on various technical solutions and protocols used in Internet. The development is also steered by the IETF (Internet Engineering Task Force), which has several sub- groups for handling various problems and planning new standards etc.

The rapid growth of Internet may also be due to several important factors:

1. Easy-to-use software -graphical browsers
2. Improved telecommunications connections
3. Rapid spread of automatic data processing, including electronic mail, bank transfers, etc.
4. The Information Superhighway projects.

The Internet Society maintains a list of Internet service providers providing connections all over the world. There is one "universal" aspect of all computers connect to the Internet i.e., they all run the TCP/IP family of protocols.

The Internet Protocol (IP) gives the physical 32-bit address, which uniquely identifies an individual computer connected to the Internet, while Transmission Control Protocol (TCP) is a connection-oriented protocol, which takes care of the delivery and order of the packages. TCP also provides the port numbers for individual services within a computer.

The major information services provided by the Internet are (with the protocol in parentheses): electronic mail (SMTP), remote file copying (FTP), remote login, terminal connections (TELNET), menu-based file access (GOPHER), Wide Area Information Servers (WAIS, Z39.50), the World Wide Web (HITP), and the Packet Internet Groper (PING).

There are three major ways to connect your computer to the Internet:

1. dial up modem access to a computer connected to Internet,
2. dial-up networking, and
3. leased lines (usually from a local telephone company).

### **Switched Dial-Up Lines**

The most common circuit provided by public communication carriers are dial-up telephone circuits. Subscribers send routing information i.e., the **dialled** number to

the network, which connects them to the receiver, then follow this with the information (speech).

Switched circuits are not permanent. They exist only for the duration of the connection and are switched by the public network (it connects the circuits). Switched dial-up lines are not generally suited to data transmission, but are used heavily for some types of services (e.g., Bulletin Boards). Using a modem, a user can use their phone line to dial up a network provider via the phone line and connect to the Internet. At present speeds up to 56Kbps are possible over standard dial up telephone circuits.

### Leased Lines

A leased line is a permanent non-switched end-to-end connection. Data is sent from one end to the other. It is not required to send routing information along with the data. Leased lines provide an instant guaranteed method of delivery. They are suited to high volume, high speed data requirements. The cost of the line (which is leased per month), is offset against that of toll or other rental charges. In addition, the leased line offers a significantly higher data transmission rate than the **dial-up circuit**. Very high speeds can be achieved on leased lines. The cost varies, and goes up according to the capacity (speed in bits per second) that the customer requires.

### Working of the Web

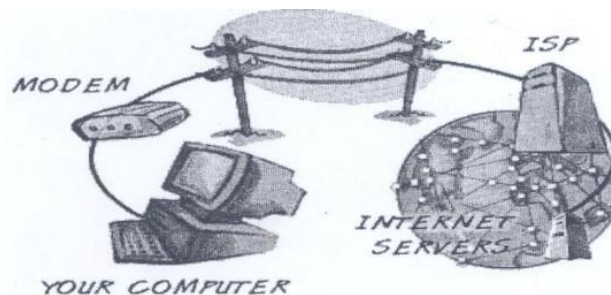

Figure 1.18: Working of internet

The Web physically consists of your personal computer, web browser software, a connection to an Internet service provider, computers called servers that host digital data and routers and switches to direct the flow of information.

The Web is known as a client-server system. Here, the Users computer is the client, and the remote computer that stores electronic files is the server.

The working of the Web **is shown in figure 1.18 and** can be explained by the following example:

Let's say you want to pay a visit to the **NOU's** website. First, you enter the address or URL of the website in your web browser (more about this in a while). Then your browser requests the web page from the web server. The **NOU's** server sends the data over the Internet to your computer. Your web browser interprets the data and displays it on your computer screen.

The glue that holds the Web together is called hypertext and hyperlinks. This feature allows electronic files on the Web to be linked so that you can easily jump between them. On the Web you can navigate through pages of information based on what interests you at that particular moment. This is commonly known as browsing or surfing the Net.

To access the Web you need software such as Netscape Navigator, **Google Chrome**, **Mozilla Firefox**, **Opera** or Microsoft Internet Explorer. These are known as web browsers. Web pages are written in a computer language called HTML, which stands for Hypertext Markup Language.

### 3.8.4 ATM Network

Asynchronous Transfer Mode (ATM) is a network technology adopted by the telecommunication sector. It is a high-performance, cell-oriented switching and multiplexing technology that utilises fixed-length packets to carry different types of traffic. The data transfer takes place in the form of cells or packets of a fixed size (53 bytes). The cell used with ATM is relatively small compared to units used with older technologies. The small constant cell size allows ATM equipment to transmit video, audio, and computer data over the same network, and assures that no single type of data hogs the line.

ATM technology is used for both local and wide area networks (LANs and WANs) that support real-time voice and video as well as data. The topology uses switches that establish a logical circuit from end to end, which guarantees quality of service (QoS). However, unlike telephone switches that dedicate circuits end-to-end, unused bandwidth in ATM's logical circuits can be utilised when needed. For example, idle bandwidth in a video conference circuit can be used to transfer data.

ATM is widely used as a backbone technology in carrier networks and large enterprises, but never became popular as a local network (LAN) topology. ATM is highly scalable and supports transmission speeds of 1.5, 25, 100, 155, 622, 2488 and 9953 Mbps. ATM is also running as slow as 9.6 Kbps between ships at sea. An ATM switch can be added into the middle of a switch fabric to enhance total capacity, and the new switch is automatically updated using ATM's **Private Network-to Network interface (PNNI)** routing protocol.

One of the important features of ATM is its ability to specify Quality of Service (QoS), allowing video and voice to be transmitted smoothly. It provides the following levels of service:

1. Constant Bit Rate (CBR) guarantees bandwidth for real-time voice and video.
2. Realtime variable Bit Rate (rt-VBR) supports interactive multimedia that requires minimal delays.
3. Non-Realtime variable-bit-rate (nrt- VBR) is used for busy transaction traffic.
4. Available Bit Rate (ABR) adjusts bandwidth according to congestion levels for LAN traffic.

5. Unspecified Bit Rate (UBR) provides the best effort for non- critical data such as file transfers.

### **Advantages of ATM**

1. Flexible bandwidth allocation.
2. Simple routing due to connection-oriented technology.
3. High bandwidth utilisation due to statistical multiplexing.
4. Potential QoS (Quality of Service) guarantees.

### **Disadvantages of ATM**

1. Overhead of cell header (5 bytes per cell).
2. Complex mechanisms for achieving Quality of Service.
3. Congestion may cause cell losses.
4. It is costly compared to IP.

## **3.9 Types of Computer Networks**

Computer Networks are mostly classified on the basis of the geographical area that the network covers, the topology used, the transmission media used and the computing model used.

Based on the geographical area covered the networks may be LAN, MAN, WAN.  
**Local Area Network was discussed in unit 1.**

### **1.9.1 Metropolitan Area Network (MAN)**

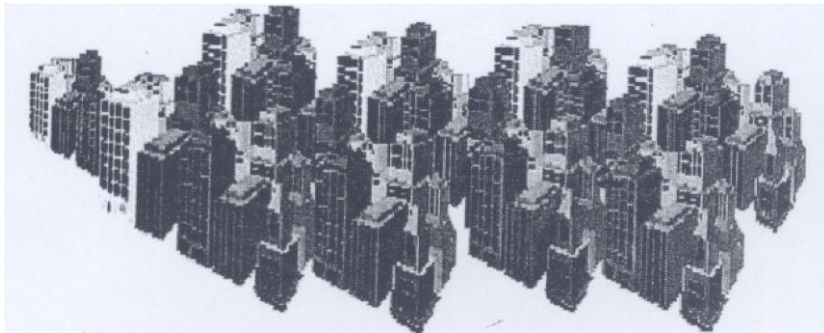

**Figure 1.19:** Metropolitan Area network

### **MAN (Metropolitan Area Network)**

Metropolitan Area Network is a Computer network designed for a town or city as shown in Figure 1.19. In terms of geographic area MAN's are larger than local-area networks (LANs), but smaller than wide-area networks (WANs). MAN's are usually characterised by very high-speed connections using fibre optical cable or other digital media.

The Typical Characteristics of a MAN are:

1. Confined to a larger area than a LAN and can range from 10km to a few 100km in length.
2. Slower than a LAN but faster than a WAN.
3. Operates at a speed of 1.5 to 150 Mbps.
4. Expensive equipment.
5. Moderate error rates.

### 3.9.2 Wide Area Network (WAN)

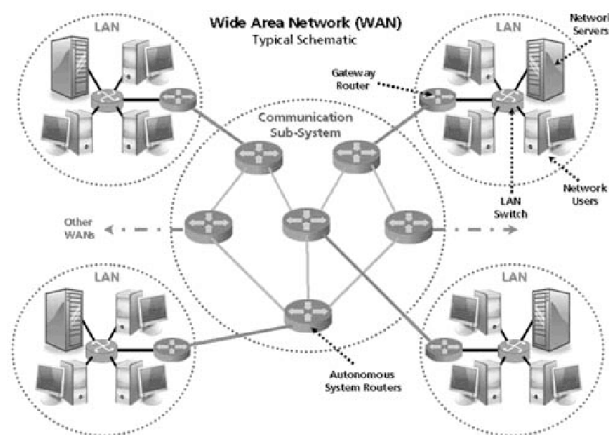

Figure 1.20: Wide area network

#### WAN (Wide Area Network)

Wide Area Network is a computer network that spans a relatively large geographical area. Typically, a WAN consists of two or more local-area networks (LANs), which are depicted, in Figure 20. They can connect networks across cities, states or even countries.

Computers connected to a wide-area network are often connected through public networks, such as the telephone system. They can also be connected through leased lines or satellites.

#### The Typical characteristics of a WAN are:

1. A WAN can range from 100km to 1000 km and the speed between cities can vary from 1.5 Mbps to 2.4 Gbps. WAN supports large number of computers and multiple host machines.
2. Various segments of network are interconnected using sophisticated support devices like routers and gateways.
3. Usually the speed is much slower than LAN speed.

4. Highest possible error rate compared to LAN & MAN.

### 3.9.3 Comparison between LAN, MAN, WAN and GAN

NETWORK	SIZE	TRANSMISSION MEDIA	MAXIMUM DISTANCE
Local Area Network	Confined to building or campus	Cable used	Covers up to 10km
Metropolitan Area Network	Network confined to city or town	Different hardware & transmission media are used	Covers the area of a city or town
Wide Area Network	Larger than MAN	Telephone lines, radio waves, leased lines or satellites.	Covers a number of cities or countries

Figure 1.21: Comparison between different types of networks.

### 3.10 Advantages of Networks

Computers in a networked environment provide numerous advantages when compared to computers in a standalone environment. The immense benefits that the computer networks provide are in the form of excellent sharing of computational resources, computational load, increased level of reliability, economy and efficient person-to-person communication.

Following are some of the major advantages of using computer networks.

#### 1. Resource Sharing

The main aim of a computer network is to make all programs, equipment, and data available to anyone on the network without regard to the physical location of the resource and the user. Users need to share resources other than files, as well. A

common example being printers. Printers are utilised only a small percentage of the time; therefore, companies don't want to invest in a printer for each computer. Networks can be used in this situation to allow all the users to have access to any of the available printers.

## **2. High Reliability**

Computer networks provide high reliability by having alternative sources of supply. For example, all files could be replicated on two or three machines, so, if one of them is unavailable (due to hardware failure), the other copies could be used. In addition, the presence of multiple CPUs means that if one goes down, the others may be able to take over its work, although at reduced performance. For military, banking, air traffic control, nuclear reactor safety, and many other applications, the ability to continue operating in the face of hardware problems is of utmost importance.

## **3. Saving Money**

Small computers have a much better price/performance ratio than larger ones. Mainframes are roughly a factor of ten faster than personal computers but they cost much more. This imbalance has caused many systems designers to build systems consisting of personal computers, one per user, with data kept on one or more shared file server machines. In this model, the users are called clients, and the whole arrangement is called the client-server model.

## **4. Scalability**

The ability to increase the system performance gradually as the workload grows just by adding more processors. With centralized mainframes, when a system is full, it must be replaced by a larger one, usually at great expense and even greater disruption to the users. With client-server model, new clients and new servers can be added when needed.

## **5. Communication Medium**

A computer network can provide a powerful communication medium among widely separated users. Using a computer network it is easy for two or more people who are working on the same project and who live far apart to write a report together. When one worker, makes a change to an on-line document, the others can see the change immediately, instead of waiting several days for a letter. Such a speedup makes cooperation among far-flung groups of people easy whereas previously it was impossible.

## **6. Increased Productivity**

Networks increase productivity as several people can enter data at the same time, but they can also evaluate and process the shared data. So, one person can handle accounts receivable, and someone else processes the profit-and-loss statements.



## **4.0 CONCLUSION**



In this introductory unit, you have learnt about the basic concepts of Computer Networks. You have not only learnt about Networks, but also about the different types of Networks, their applications, Network Topology, Network protocols, OSI reference mode and the TCP/IP reference model which is the most commonly used on the Internet today. Also, the importance of the network protocols and the importance of using networked system have been extensively discussed.



## 5.0 SUMMARY

In this unit we have learnt about the basic concepts of Networking. Here we discussed the different types of networks and the difference between them. Computer networks are basically classified as LAN, MAN, WAN depending on the geographical distance covered and depending on the various ways of interconnecting computers in a network (network topology) like Star, Bus, Ring, Tree, Mesh and cellular topologies.

We have seen the immense benefits that the computer networks provide in the form of excellent sharing of computational resources, computational load, increased level of reliability, economy and efficient person-to-person communication. Here we have briefly explained some of the network protocols which define a common set of rules and signals that computers on the network use to communicate with each other.

Standard network architecture is required for meaningful communication between end systems. We have discussed the two most widely used reference models i.e., the OSI reference model and the TCP/IP reference model. Nowadays, we come across different types of networks like Public networks, Research networks, Co-operative networks, Commercial networks etc. and we have learnt about some of the popular networks such as Novell NetWare, ARPANET, Internet, ATM network. Towards the end of this unit the concept of delays was also introduced.



## 6.0 TUTOR MARKED ASSIGNMENT 1

1. Briefly describe NCP and IPX of Novell NetWare reference model.
2. List the basic components (equipment) **needed** to connect a computer to the Internet.
3. What are advantages of having small fixed size cells in ATM?



## 7.0 REFERENCE/FURTHER READINGS

Andrew S. Tenenbaum, *Computer Networks*, PHI, New Delhi.

William Stalling, *Data and Computer Communication*, PHI, New Delhi

## 8.0 ANSWERS TO SELF-ASSESSMENT EXERCISES 1

### Question 1



Explain the difference between Client/ server and peer-to-peer architecture

**Solution**

The difference between client/server and peer-to-peer architecture are illustrated in the table 1.1.

Table 1.1: *The difference between client/server and peer-to-peer architecture*

S/N	Client/server architecture	Peer-to-peer architecture
a.	This involves dedicated server and specific clients	Here, nodes act as servers and at the same time act as clients
b.	Here, services are provided to the clients	In this architecture, each peer has the ability to give services and receive services.
c.	Each age of information is more important here	In this case, connection between peers is more vital
d.	The storage of data is centralised	Each peer stores its own data
e.	There are room for bottleneck since the server is centralized	There are no room for bottleneck since the server is a distributed system
f.	This is more expensive to administer	This is less scalable and stable

**Question 2**

List the important aspect that should be kept in mind while designing a network

**Solution**

The important factors that should be noted while building a network are;

- a. It is pertinent to have a thorough knowledge of what the network will be used for to avoid confusion during the network installation
- b. You should have a very good budget for an IT network, manage he budget properly and reserve capital for IT essentials.
- c. Giving of adequate installation in the form of training, providing good safety system and making sure the network has the ability to respond to future increase demand of the system is very important in the design of a good network.
- d. Having adequate plan to keep the IT system in good condition is very vital to the sustainability of the network. In other words, there should be good strategies for maintaining the system.
- e. Create room for redundancy in the case of sudden breakthrough of the network.
- f. Write briefly about the areas where networks are used.

### **Question 3**

Write briefly about the areas where networks are used.

### **Solution**

A network is the linking of individuals and devices together. These networks are used in virtually every aspect of lives, ranging from offices where you share printers, world Wide Web (WWW) you exchange information, digital video share among friends through social media and e-mail address and sharing of applications and storage servers

### **Question 4**

Differentiate between broadcast and point-to-point networks.

### **Solution**

Broadcast is a method of sending message from individual person or devices to multiple person or devices. In other words, it is a method of connection between one node and many networking nodes.

While point-to-point is a method of sending message from one individual or devices to another individual or devices. In other words, it is a method of having direct connection between two entities or networking nodes.

## **ANSWERS TO SELF-ASSESSMENT EXERCISES 2**

### **Question 1**

List the importance of using computer networks in Airline and Railway reservation systems.

### **Solution**

The importance of using Computer networks in Airline and Railway Reservation Systems:

- a. Computer devices are used for booking and reservations
- b. They are used for maintaining time-table
- c. They are used for scheduling crews
- d. They are used for managing the movement of Airline and control of Railways reservation System, most especially, the underground railways.

### **Question 2**

What are the various types of networks

### **Solution**

The various types of networks are

- a. Personal Area Network (PAN)
- b. Local Area Network (LAN)
- c. Wireless Local Area Network (WLAN)
- d. Campus Area Network (CAN)
- e. Metropolitan Area Network (MAN)
- f. Wide Area Network (WAN)
- g. Storage Area Network (SAN)
- h. System Area Network (SAN)
- i. Passive Optical Local Area Network (POLAN)
- j. Enterprise Private Network (EPN)
- k. Virtual Private Network (VPN)

### **Question 3**

Compare tree topology with Star topology

### **Solution**

Table 1.2: Difference between Tree topology ad Star topology

S/N	Tree topology	Star topology
1.	The nodes are linked to the central hub, switch or router.	The nodes are arranged in the form of a tree
2.	Exchange of information between nodes are performed through branching cable without loops	Exchange of information that are between nodes are performed via central nodes, switch or hub
3.	The structure is complex	The structure is simple
4.	The cost of setting it up is high due to the density of the wiring system	The cost of setting it uo is cheaper than the tree topology.
5.	The topology is hierarchical in nature, so, it is also called hierarchical topology	The topology is called star topology
6.	This is mostly used in WAN	This is mostly used in LAN since the setup and modification is not too difficult.

### **Question 4**

Suppose we are to add new nodes to the network, then which is the best suited topology and why?

### **Solution**

It is important to note that all the different types of networks have their own advantages and disadvantages. However, since we are adding node to the network, Star topology will be the best.

This is because Star topology is good for a small network, most especially, if it is with a few nodes. It is important also, to make sure that the central node is in good order

and always functioning. The switches, routers or hubs should be well secured since they are the heart of the system.

### **ANSWERS TO SELF-ASSESSMENT EXERCISES 3**

#### **Question 1**

Give two reasons for using layered protocols

#### **Solution**

Layered protocols are used to make:

1. Simple, the design process, hence, give proper definition of the functions of each layer and the interaction between them.
2. The network pliable so that it can be easy to modify and develop.

#### **Question 2**

Explain OSI reference model in detail.

#### **Solution**

The student is referred to section 3.6.1, pages 19-27

#### **Question 3**

Explain the TCP/IP reference model in detail

#### **Solution**

The student is referred to section 3.6.2, pages 27-31

#### **Question 4**

Bring out the difference between TCP and UDP

Table 1.3: difference between TCP and UDP

S/N	TCP	UDP
1.	Connection oriented protocols i.e., link the sender and receiver before sending data	Connection oriented protocol i.e., does not link sender and receiver before sending data
2.	It is reliable. Data sent are sure to be delivered to the receiver. If there is failure along the way, it resends the data. It also checks for error in the packet so that it is not lost or	It is unreliable. There is no assurance of delivering the datagram packet. The datagram packet may be lost or corrupted along the way.

	corrupted.	
3.	There exists flow control which make sure the sender does not overpower the receiver by sending too many packets at the same time.	It does not give room for flow control. Packet are received in ceaseless manner or dropped.
4.	The setup and arrangement of packet is to make sure it is delivered in the manner it was sent.	The packet can be sent in any order.
5.	The speed is slow because of lots of process are involved i.e, confirm link check error and make sure the files were received in the sequence they were sent.	The speed is fast because there are no much process involved.
6.	It is very good for applications that need reliability but less time e.g., World Wide Web (HTTP, HTTPS), secure sell (SSH), File Transfer protocol (FTP), Email (SMTP, IMAP/POP)	It is very good for applications that require speed and efficiency with less reliability e.g., VPN tunnelling, streaming videos, online games, live broadcast, Domain Name System (DNS), Voice Over Internet Protocol (VOIP), trivial File Transfer Protocol

## 9.0 ANSWERS TO TUTOR MARKED ASSIGNMENT 1

### Question 1

Briefly describe NCP and IPX of Novell Netware reference model

#### **Solution**

Netware core Protocol (NCP) is employed in some of the Novell, incorporated products. It is in most cases connected with Novell Netware client-server operating system. This initially gave reinforce MSDOS client stations and subsequently reinforce Microsoft windows, classic MAC OS Linux windows NT, MAC OS X and diverse spices of Unix. You can have access to file print, remote command execution and many network services functions through NCP.

IPX/SPX on the other hand was executed on the Novell Netware dais but is now out of date.

### Question 2

List the basic components (equipment) needed to connect a computer to the Internet

#### **Solution**

The basic components (equipment) needed to connect a computer to the Internet are:

- a. Digital subscriber line modem

- b. Digital subscriber line/broadband filter
- c. Firewall and NAT router
- d. Computer firewalls
- e. ICS Internet connection sharing
- f. Network hubs, bridges and switches
- g. Wireless Access point
- h. Power over Internet (ROE) injector
- i. Routers
- j. WIFI range
- k. Extend/Repeater
- l. MIFI Broadband WIFI Hub
- m. Home Plug Adapter
- n. Unshielded twisted Pair (UTP) cables etc.

### **Question 3**

What are the advantages of having small fixed size cells in ATM?

### **Solution**

The advantages are:

- a. The usage of small cells may distract the orderliness of the queue for a high-priority cell because the queue is slowdown if it comes in a little bit later behind a lower priority cell that have started using the resources (for example a transmitter).
- b. There is an opportunity to switch more efficiently. Fixed-size cells which is very vital to high data rate of ATM.

## **UNIT 2      DATA TRANSMISSION**

### **CONTENTS**

- 1.0 Introduction
- 2.0 Objectives
- 3.0 Main Content
  - 3.1 Data Communication Terminology
    - 3.1.1 Channel
    - 3.1.2 Baud
    - 3.1.3 Bandwidth
    - 3.1.4 Frequency
  - 3.2 Modes of Data Transmission
    - 3.2.1 Serial and Parallel Communication
    - 3.2.2 Synchronous, Asynchronous and Isochronous Communication
    - 3.2.3 Simplex, Half Duplex and Full Duplex Communication
  - 3.3 Analogue and Digital Data Transmission
  - 3.4 Transmission Impairments
    - 3.4.1 Attenuation
    - 3.4.2 Delay Distortion
    - 3.4.3 Noise
    - 3.4.4 Concept of Delays
  - 3.5 Transmission Media and its Characteristics
    - 3.5.1 Magnetic media
    - 3.5.2 Twisted Pair
    - 3.5.3 Baseband Coaxial Cable
    - 3.5.4 Broadband Coaxial Cable
    - 3.5.5 Optical Fibre
    - 3.5.6 Comparison between Optical Fibre and Copper wire
  - 3.6 Wireless Transmission
    - 3.6.2 Microwave Transmission
    - 3.6.2 Radio Transmission
    - 3.6.3 Infrared and Millimetre Waves
  - 3.7 Wireless LAN
- 4.0 Conclusion
- 5.0 Summary
- 6.0 Tutor-Marked Assignment
- 7.0 References/Further Readings



### **1.0 INTRODUCTION**

Communication from a source to a destination, that is, from one computer to another or from one device to another, involves the transfer of information from the sender to

the receiver. The transfer of data from one machine to another machine such that, the sender and the receiver both interpret the data correctly is known as Data Communication.

All communication between devices requires that the devices agree on the format of the data. The set of rules defining a format is known as a protocol. At the very least, a communications protocol must define the following:

1. Transmission media used.
2. Rate of transmission (in baud or bps).
3. Whether transmission is to be synchronous or asynchronous.
4. Whether data is to be transmitted in half-duplex or full-duplex mode.

In order to understand this, we need to learn about some of the basic concepts and terminologies related to data transmission, which we will be **explained** in this unit.



## 2.0 OBJECTIVES

After going through this unit, you should be able to:

1. understand the concept of Transmission terminology
2. differentiate between Serial and Parallel communication
3. differentiate between Analogue and Digital Data Transmission
4. have a broad idea about the different Transmission Impairments
5. compare the different Transmission Media and their characteristics
6. understand Wireless Transmission and realise its importance.



## 3.0 MAIN CONTENT

### 3.1 Data Communication Terminology

The transfer of data from one machine to another machine such that, the sender and the receiver both interpret the data correctly is known as Data Communication.

#### 3.1.1 Channel

In communications, the term channel refers to a path of communications between two computers or devices. A communication channel provides everything that is needed for the transfer of electronic information from one location to another. It may refer to the physical medium, such as coaxial cable, or to a specific carrier frequency (sub-channel) within a larger channel or a wireless medium.

The channel capacity of a transmission system is the maximum rate at which information can be transferred reliably over a given period of time. Two basic types of channels that are used in voice and data communication are Analogue and Digital.

The Analogue type of channel transmits signals generally using sinusoidal waves as shown in Figure 1.22. Non-sinusoidal waves can also be used for transmission. The commercial radio station and Public telephone system are examples of this type. The



Digital type of channel transmits pulsed wave signals, such as, those shown in **Figure 1.23**.

### **3.1.2 Baud**

Pronounced bawd, Baud is the number of signalling elements that occur each second. The term is named after **J.M.E. Baudot**, the inventor of the Baudot telegraph code.

At slow speeds, only one bit of information (signalling element) is encoded in each electrical change. The baud, therefore, indicates the number of bits per second that are transmitted. For example, 300 baud means that 300 bits are transmitted each second (abbreviated 300 bps). Assuming asynchronous communication, which requires 10 bits per character, this translates in to 30 characters per second (cps). For slow rates (below 1,200 baud), you can divide the baud by 10 to see how many characters per second are sent.

At higher speeds, it is possible to encode more than one bit in each electrical change. 4,800 baud may allow 9,600 bits to be sent each second. At high data transfer speeds; therefore, data transmission rates are usually expressed in bits per second (bps) rather than baud. For example, a 9,600bps modem may operate at only 2,400 baud.

### **3.1.3 Bandwidth**

The amount of data or signals that the transmission media can carry in a fixed amount of time is called Bandwidth. The Bandwidth depends upon the length, media and signalling technique used. A high bandwidth allows increased throughput and better performance. A medium that has a high capacity has a high bandwidth. A medium that has limited capacity has a low bandwidth. It is calculated using the difference between the highest and the lowest frequencies that the medium can carry. For digital devices, the bandwidth is usually expressed in bits per second (bps) or bytes per second. For analogue devices, the bandwidth is expressed in cycles per second, or Hertz (Hz).

Bandwidth is particularly important for I/O devices. For example, a fast disk drive can be hampered by a bus with a low bandwidth.

### **3.1.4 Frequency**

Frequency is the number of cycles or periods a signal completes within one second. The unit of measuring frequency is called Hertz named after a German mathematician **Heinrich Hertz**. One Hz is one cycle/second. We use one Kilohertz or one kHz to mean 1000Hz and one Megahertz or one MHz to mean 1000 kHz or 1000000Hz.

## **3.2 Modes of Data Transmission**

Data can be transmitted from Source to Destination in a number of ways. The different modes of data transmission will be outlined as follows:

1. Parallel and Serial Communication.
2. Asynchronous, Synchronous and Isochronous Communication.
3. Simplex, Half duplex and Full duplex Communication.

### 3.2.1 Serial and Parallel Communication

There is always a need to exchange commands, data and other control information between two communicating devices. There are mainly two options for transmitting data, commands and other control information from the sender to the receiver. These are:

1. Serial communication.
2. Parallel communication.

#### Serial Communication

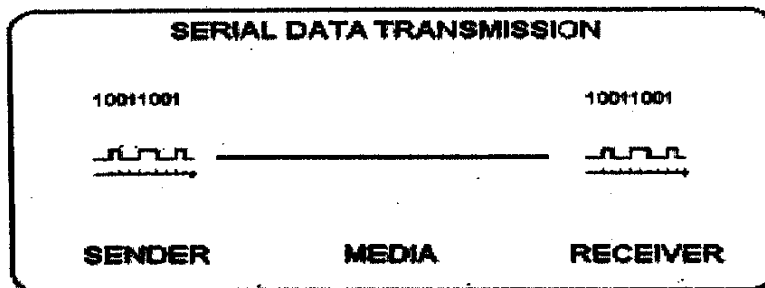

Figure 1.22: Serial Communication

In Serial data transmission, bits are transmitted serially, one after the other, as shown in Figure 1.22. The least significant bit (LSB) is usually transmitted first. While sending data serially, characters or bytes have to be separated and sent bit by bit. Thus, some hardware is required to convert the data from parallel to serial. At the destination, all the bits are collected, measured and put together as bytes in the memory of the destination. This requires conversion from serial to parallel.

As compared to parallel transmission, serial transmission requires only one circuit interconnecting the two devices. Therefore, serial transmission is suitable for transmission over long distances.

#### Parallel Communication

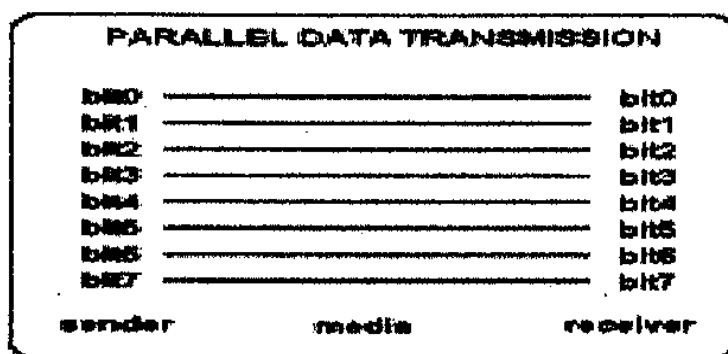

Figure 1.23: Parallel Data Transmission

In Parallel transmission, all the bits of a byte are transmitted simultaneously on separate wires as shown in the Figure 1.23. Here, multiple connections between the

two devices are therefore, required. This is a very fast method of transmitting data from one place to another.

The disadvantage of Parallel transmission is that it is very expensive, as it requires several wires for both sending, as well as receiving equipment. Secondly, it demands extraordinary accuracy that cannot be guaranteed over long distances.

### 3.2.2 Asynchronous, Synchronous and Isochronous Communication

One of the major difficulties in data transmission is that of synchronising the receiver (destination) with the sender (source). This is the main problem with serial communication. The receiver must be able to detect the beginning of each new character in the bit stream, that is, being presented to it and if it is not able to achieve this, it will not be able to interpret the incoming bit stream correctly.

The three mechanisms used for synchronisation are:

1. Asynchronous Communication
2. Synchronous Communication
3. Isochronous Communication

#### Asynchronous Communication

Asynchronous communication sends individual characters one at a time framed by a start bit and 1 or 2 stop bits. Each frame begins with a start bit that enables the receiving device to adjust to the timing of the transmitted signal. The message can begin at any time. Here, messages are kept as short as possible because, the sending and receiving devices should not drift out of synchronisation, when the message is being transferred. Asynchronous communication is most frequently used to transmit character data and is ideally suited for characters that are transmitted at irregular intervals, such as, when users are typing in character data from the keyboard.

A typical frame used to transmit a character data has four components:

1. **A start bit:** Signals the starting a frame and enables the receiving device to synchronise itself with the message.
2. **Data Bits:** Consists of 7 or 8 bits when character data is being transmitted.
3. **Parity Bits:** Optionally used as a crude method for detecting transmission errors.
4. **A stop bit or bits:** Signals the end of the data frame.

Error detection in asynchronous transmission makes use of the parity bit Parity techniques can detect errors that affect only one bit and if two or more bits are affected by errors, the parity techniques may not be able to detect them.

#### Advantages of Asynchronous Communication

1. Asynchronous transmission is simple, inexpensive and is ideally suited for transmitting small frames at irregular intervals (e.g., Data entry from a keyboard).
2. As each individual character is complete in itself, if a character is corrupted during transmission, its successor and predecessor will not be affected.

### **Disadvantages of Asynchronous Communication**

1. As start, stop and parity bits must be added to each character that is to be transmitted, this adds a high overhead to transmission. This wastes the bandwidth; as a result, asynchronous transmission is undesirable for transmitting large amounts of data.
2. Successful transmission inevitably depends on the recognition of the start bits, hence, as these bits can be easily missed or occasionally spurious, as start bits can be generated by line interference, the transmission may be unsuccessful.
3. Due to the effects of distortion the speed of asynchronous transmission is limited.

### **Synchronous Communication**

In synchronous communication the whole block of data bits is transferred at once, instead of one character at a time. Here, transmission begins at a predetermined regular time instant. A sync signal is used to tell the receiving station that a new frame is arriving and to **synchronise** the receiving station.

Sync signals, generally **utilise** a bit pattern that cannot appear elsewhere in the messages, ensuring that they will always be distinct and easy for the receiver to **recognise**. As the transmitter and receiver remain in **synchronisation** for the duration of the transmission, frames can be of longer length.

As frames are longer, the parity method of error detection is not suitable because, if multiple bits are affected, then, the parity technique will not report error accurately. Hence, the technique used with synchronous transmission is the Cyclic Redundancy Check (CRC).

The transmitter uses an algorithm to calculate a CRC value that **summarises** the entire value of data bits. This CRC value is appended to the data frame. The receiver uses the same algorithm, recalculates the CRC and compares the CRC in the frame to the value that it has calculated. If these values match then, it is sure that the frame was transmitted without error.

An end bit pattern indicates the end of the frame. Like sync the bit pattern for end is such that, it will not appear elsewhere in the messages, ensuring that they will always be distinct and easy for the receiver to **recognise** at the end of the frame.

Serial synchronous transmission is used for high-speed communication between computers. It is used when high **volumes** of data are to be transmitted.

### **Advantages of Synchronous Communication**

1. Synchronous transmission is more efficient because, only 4 additional bytes (for start and end frames) are required to transmit up to 64 k bits.
2. Synchronous transmission is not really prone to distortion, as a result, it can be used at high-speeds.

### **Disadvantages of Synchronous Communication**

1. Synchronous transmission is expensive as complex circuitry is required and it is difficult to implement.
2. If an error occurs during transmission, rather than just a single character the whole block of data is lost.
3. The sender cannot transmit characters simply, as they occur, but has to store them until it has built up a block. Thus, this is not suitable where characters are generated at irregular intervals.

### **Isochronous Communication**

This method combines the approaches of asynchronous and synchronous communications. As in the asynchronous method, each character has both the start and stop bits. The idle period (where no transmission takes place) between the two characters is not random but an exact multiple of one-character time interval. If, the time to transmit a character (including its parity, start, stop bits) is  $t$ , the time interval between characters cannot be random as in the asynchronous method. It is also not 0 as in the synchronous method. It has to be  $t, 2t, 3t, \dots, nt$  where  $n$  is any positive integer. Here, the signal is expected to be received within certain delay bounds say  $T_{min}$  to  $T_{max}$ .

### **Advantages of Isochronous Communication**

1. Isochronous transmission guarantees transmission rates, and it is almost deterministic.
2. It has low overheads.
3. It has high speed.

### **Disadvantages of Isochronous Communication**

1. In isochronous transmission it is necessary to ensure that the clocking device is fault tolerant.

### **3.2.3 Simplex, Half Duplex and Full Duplex Communication**

This classification of data transmission is based on the question of, communication can send data and at what point of time.

The three basic ways in which this can be done are:

2. Simplex.
3. Half Duplex
4. Full Duplex, sometimes called Duplex.

### Simplex

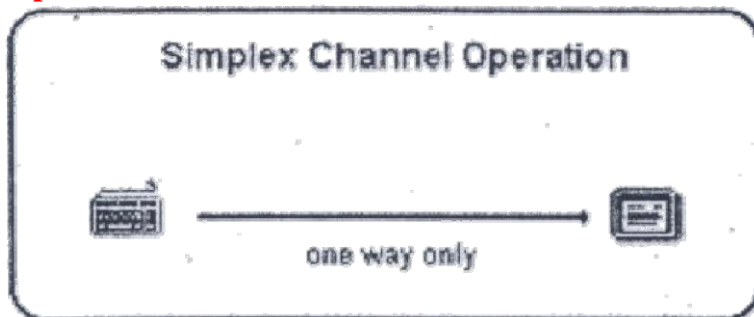

Figure 1.24: Simplex connection

The simplest signal flow technique is the simplex configuration. In Simplex transmission, one of the communicating devices can only send data, whereas the other can only receive it. Here, communication is only in one direction (unidirectional) where one party is the transmitter and the other is the receiver as shown in the *Figure 1.24*. Examples of simplex communication are the simple radio, and Public broadcast television where, you can receive data from stations but can't transmit data back. The television station sends out electromagnetic signals. The station does not expect and does not monitor for a return signal from the television set. This type of channel design is easy and inexpensive to set up.

### Half Duplex

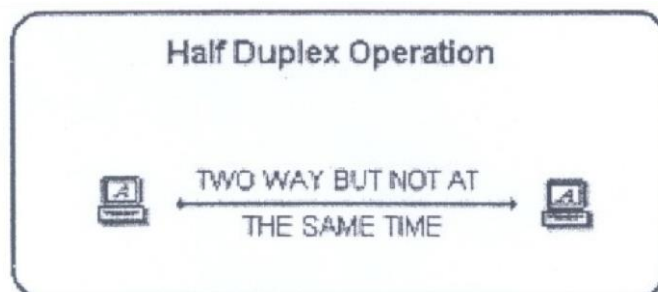

Figure 1.25: Half duplex connection

Half duplex refers to two-way communication where, only one party can transmit data at a time. Unlike, the Simplex mode here, both devices can transmit data though, not at the same time, that is Half duplex provides Simplex communication in both directions in a single channel as shown in *Figure 1.25* When one device is sending

data, the other device must only receive it and vice versa. Thus, both sides take turns at sending data. This requires a definite turn around time during which, the device changes from the receiving mode to the transmitting mode. Due to this delay, half duplex communication is slower than simplex communication. However, it is more convenient than simplex communication as both the devices can send and receive data.

Note, the difference between simplex and half-duplex. Half-duplex refers to two-way communication where, only one party can transmit data at a time. Simplex refers to one-way communication where, one party is the transmitter and the other is the receiver. For example, a walkie-talkie is a half-duplex device because only one party can talk at a time.

Most modems contain a switch that lets you select between half-duplex and full-duplex modes. The correct choice depends on which program you are using to transmit data through the modem.

### Full Duplex

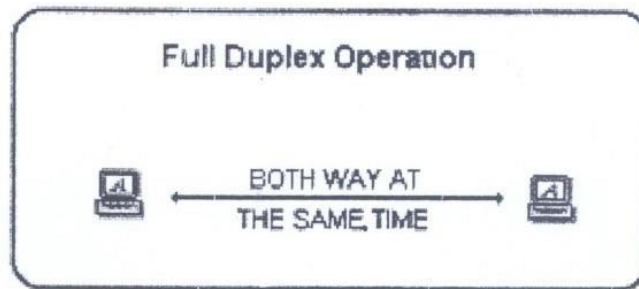

Figure 1.26: Full duplex connection

Full duplex refers to the transmission of data in two directions simultaneously. Here, both the devices are capable of sending as well as receiving data at the same time as shown in Figure 1.26. As you can see from Figure 1.26, that simultaneously bi-directional communication is possible, as a result, this configuration requires full and independent transmitting and receiving capabilities at both ends of the communication channel. Sharing the same channel and moving signals in both directions increases the channel throughput without increasing its bandwidth. For example, a telephone is a full-duplex device because both parties can talk to each other simultaneously. In contrast, a walkie-talkie is a half-duplex device because only one party can transmit at a time.

Most modems have a switch that lets you choose between full-duplex and half-duplex modes. The choice depends on which communications program you are running.



#### SELF ASSESSMENT EXERCISE 4

1. What is Data Communication?
2. Explain the term bandwidth. Why is bandwidth useful?

3. Compare Parallel and Serial transmission methods and **describe** the situation where Parallel transmission is a better choice as compared to serial transmission.
4. Give reasons as to why Full duplex is more challenging **than** simplex and half duplex transmission.
5. Bring out the difference between Synchronous, Asynchronous and Isochronous transmission.

### 3.3 Analogue and Digital Data Transmission

We know that the two major types of signals are Analogue and Digital. The manner in which these two types of signals can be transmitted from source to destination is of the same two types that is:

1. Analogue data transmission.
2. Digital data transmission.

#### Analogue Signal

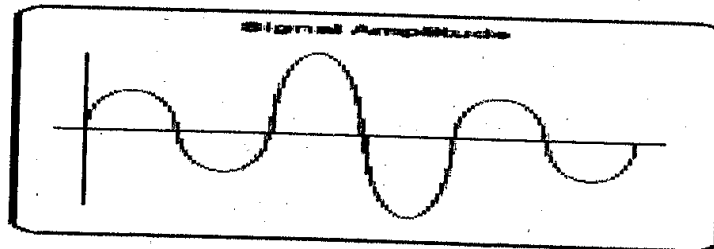

Figure 1.27: Analogue signal

Analogue signals vary constantly in one or more values; these changes in values can be used to represent data. An analogue signal is continuous and can be represented by using sine waves. Human voice, video and music are all examples of analogue signals, which vary in amplitude (volume) and frequency (pitch). Human voice generates an analogue (continuously varying) signal containing multiple frequencies that is transmitted as an analogue signal over the medium. Amplifiers are used to overcome the attenuation that the signal suffers on its way. The drawback is that amplifiers amplify noise along with the original signal and hence, if the signal gets distorted, it cannot be reconstructed and it is a permanent loss. Due to this reason, this type of transmission is not used where a high level of accuracy is needed. This is used in telephony where a slight distortion in human communication does not matter.

The ability to capture the subtle nature of the real world is the single advantage of analogue techniques. However, once captured, modern electronic equipment, no matter how advanced, cannot copy analogue signals perfectly. Third and fourth generations of audio and video recordings show marked deterioration.

By converting analogue signals into digital, the original audio or video data can be preserved indefinitely within the specified error bounds and copied over and over without deterioration. Once continuously varying analogue signals are measured and



converted into digital form, they can be stored and transmitted without loss of integrity due to the accuracy of digital methods.

### Digital Data Transmission

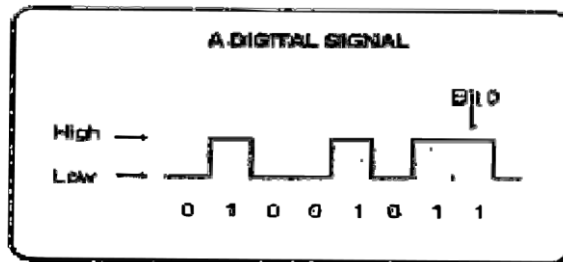

Figure 1.28: Digital Data Transmission

Digital data transmission describes any system based on discontinuous data or events. Computers are digital machines because at their most basic level they can distinguish between just two values, 0 and 1, or off and on. There is no simple way to represent all the values in between, such as 0.25. All data that a computer processes must be encoded digitally, as a series of zeroes and ones.

Information coming out of the computer is in the form of digital signals. The bandwidth of a digital signal is infinite as compared to any medium, which has a limited bandwidth. Therefore, as the signal is generated and enters the medium, at that point of entry, only limited frequencies are permissible on the medium and this depends upon the bandwidth. As the signal traverses over the medium it gets distorted and beyond a certain distance, the signal becomes unrecognisable from the original one. A hardware device called Repeater is used to regenerate the digital signal.

The repeater measures the signal values at regular intervals to recognise the 0's and 1's in the signal and regenerates them. Hence, there is no loss of information. The number of repeaters to be used depends on the distance between the source and the destination. Any line with repeaters placed at appropriate distance is called a digital line.

When information, music, voice and video are turned into binary digital form, they can be electronically manipulated, preserved and regenerated perfectly at high speed. The millionth copy of a computer file is exactly the same as the original. This is, nevertheless, a major advantage of digital processing.

### 3.4 Transmission Impairments

When data is transmitted from a transmitter to receiver, there is scope for transmission errors. If, transmission media were perfect, the receiver would receive exactly the same signal that the transmitter sent. Unfortunately, media are not perfect, so the received signal may sometimes not be the same as the transmitted signal.

Transmission lines suffer from three major problems:

1. Attenuation.
2. Delay distortion.
3. Noise.

### **3.4.1 Attenuation**

Attenuation is the loss of energy as the signal propagates outwards. On guided media (e.g., wires and optical fibres), the signal falls off logarithmically with the distance. Attenuation is very small at short distances; therefore, the original signal can be recognised without too much distortion. Attenuation increases with distance as, some of the signal energy is absorbed by the medium. The loss is expressed in decibels per kilometre (db/km). The amount of energy lost depends on the frequency. Attenuation is also higher at higher frequencies.

If the attenuation is high, the receiver may not be able to detect the signal at all, or the signal may fall below the noise level. In many cases, the attenuation properties of a medium are known, so amplifiers can be put in place to try to compensate for the frequency-dependent attenuation. This approach helps but can never restore the signal exactly back to its original shape.

### **3.4.2 Delay Distortion**

Delay distortion is caused by the fact that the signals of varying frequencies travel at different speeds along the medium. Any complex signal can be decomposed into different sinusoidal signals of different frequencies, resulting, in a frequency bandwidth for every signal.

One property of signal propagation is that the speed of travel of the frequency is the highest at the centre of this bandwidth, and lowest at both ends. Therefore, at the receiving end, signals with different frequencies in a given bandwidth will arrive at different times. If, the signals received are measured at a specific time, they will not be exactly like the original signal resulting in its misinterpretation.

For digital data, fast components from one bit may catch up and overtake low components from the bit ahead, mixing the two bits and increasing the probability of incorrect reception.

### **3.4.3 Noise**

Noise is unwanted energy from sources other than the transmitter. Thermal noise is caused by the random motion of the electrons in a wire and is unavoidable. Cross talk is caused by inductive coupling between two wires that are close to each other. Sometimes when talking on the telephone, you can hear another conversation in the background. That is crosstalk. Finally, there is impulse noise, caused by spikes on the power line or other causes. For digital data, impulse noise can wipe out one or more bits.

### **3.4.3 Concept of Delays**

The average delay required to deliver a packet from source (origin) to destination has a large impact on the performance of a data network. Delay considerations strongly influence the choice and performance of network algorithms, such as routing and flow control. Because of these reasons, it is very important to understand the nature

and mechanism of network delay, and the manner in which it depends on the characteristics of the network.

A large delay is disastrous for data transfer. The total delay can be categorised into two types. The first type is fixed delay. This is the total delay which is always present due to buffering, link capacity etc. The second type is variable delay. This is the delay component which is caused by packets queuing in the routers, congestions etc. Among the different types of delays, here, we shall discuss Transmission delay and Propagation delay.

### **Transmission delay**

Transmission delay is the delay, which is present due to link capacities. When resource reservation methods are supported in routers, transmission delays can probably be kept low enough to satisfy the overall delay constraint of 200 ms.

When data is transmitted, there is always a minimal amount of delay, due to the capacity of the links along which the data travels. But the most significant part of the delay of transmission is usually due to queuing of packets inside routers. This delay is highly variable and depends both on the number of routers along the path and the load of the routers.

### **Propagation delay**

Satellite microwave systems can reach remote places on the earth and can also communicate with mobile devices. As the signal travels a long distance (around 36,000 km), there is a delay of about 5 ms between, the transmission and the reception of the signal. This delay is known as the propagation delay. Such delays occur in all communication channels, however, small they may be.

Propagation delay is the time between the last bit transmitted at the head node of the link and the time the last bit is received at the tail node. This is proportional to the physical distance between the transmitter and the receiver; it can be relatively substantial, particularly for a satellite link or a very high-speed link.

The propagation delay depends on the physical characteristics of the link and is independent of the traffic carried by the link.

## **3.5 Transmission Media and its Characteristics**

Various physical media can be used for the actual transmission of information from one place to another. Each one has its own niche in terms of bandwidth, delay, cost, ease of installation and maintenance. Transmission media are roughly grouped into guided media, such as copper wire and fibre optics, and unguided media, such as radio and lasers.

### **3.5.1 Magnetic Media**

One of the most common ways to transport data from one computer to another is to write them onto magnetic tape or floppy disks, physically transport the tape or disks

to the destination machine, and read them back in again. While, this method is not as sophisticated as using a geosynchronous communication satellite, it is often much more cost effective, especially for applications in which high bandwidth or cost per bit transported is the key factor.

### 3.5.2 Twisted Pair

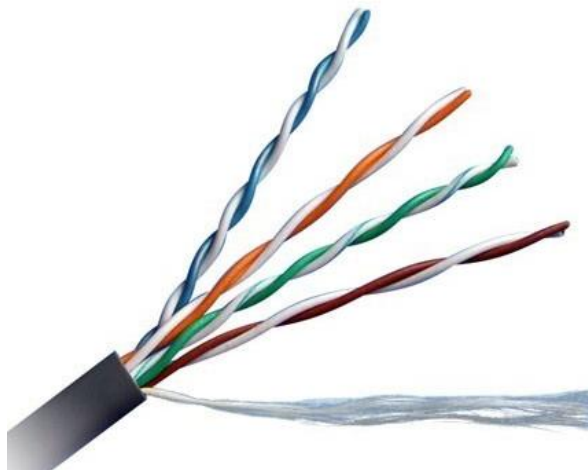

Figure 1.29: Twisted pair cable

Although, the bandwidth characteristics of magnetic tape are excellent, the delay characteristics are poor. Transmission time is measured in minutes or hours, not milliseconds. For many applications, an on-line connection is needed. The oldest and still most common transmission medium is the twisted pair. A twisted pair as shown in figure 1.29 consists of two insulated copper wires, typically about 1 mm thick. The purpose of twisting the wires is to reduce electrical interference from similar pairs that may be close by.

The most common application of the twisted pair is in the telephone system. Nearly all telephones are connected to the telephone company office by a twisted pair. Twisted pairs can run several kilometres without amplification, but for longer distances, repeaters are needed. When many twisted pairs run in parallels for a substantial distance, such as, all the wires coming from an apartment building to the telephone company office, they are bundled together and encased in a protective sheath. The pairs in these bundles would interfere with one another if, it were not twisted.

Twisted pairs can be used for either analogue or digital transmission. The bandwidth depends on the thickness of the wire and the distance travelled, but several megabits/sec can be achieved for a few kilometres in many cases.

Twisted pair cable has the following advantages:

Adequate performance and lowest cost per meter as compared to other cable types as these are inexpensive to install, makes twisted pairs popular and hence, they are widely used and are likely to remain so for years to come.

### 3.5.3 Baseband Coaxial Cable

Another common transmission medium is the coaxial cable (also known as “coax”). It has better shielding than twisted pairs, so it can span longer distances at higher speeds. A coaxial cable consists of a stiff copper wire as the core, surrounded by an insulating material. The insulator is encased by a cylindrical conductor, often, as a closely woven braided mesh. The outer conductor is covered with a protective plastic sheath. A cutaway view of a coaxial cable is shown in [Figure 1.30](#).

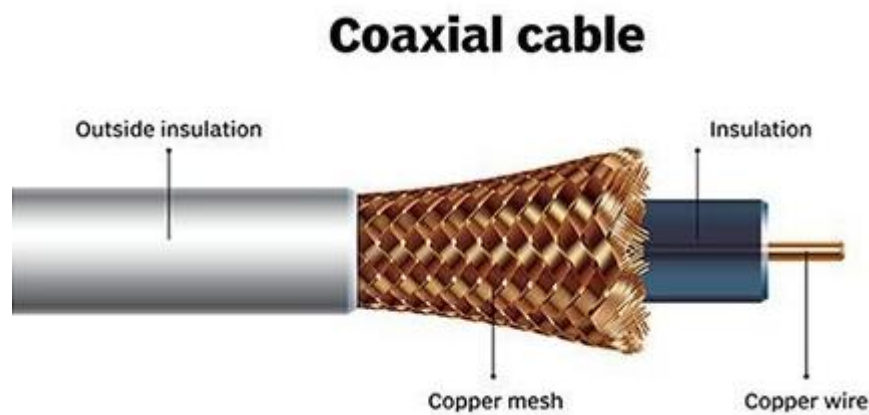

[Figure 1.30](#): Coaxial cable

The construction and shielding of the coaxial cable gives it a good combination of high bandwidth and excellent noise immunity. The bandwidth possible depends on the cable length. For I-kin cables, a data rate of 1 to 2 Gbps is feasible. Longer cables can also be used, but only at lower data rates or with periodic amplifiers. Coaxial cables used to be widely used within the telephone system but, have now largely been replaced by fibre optics on long-haul routes. Coax is still widely used for cable television and some local area networks.

### 3.5.4 Broadband Coaxial Cable

The other kind of coaxial cable system uses analogue transmission on standard cable television cabling. It is called broadband. Although the term “broadband” comes from the telephone world, where it refers to anything wider than 1 MHz, in the computer networking world “broadband cable” means any cable network using analogue transmission.

Since, broadband networks use standard cable television technology, the cables can be used up to 300 MHz (and often up to 450 MHz) and can run for nearly 100 km due to the analogue signalling, which is much less critical than digital signalling. To transmit digital signals on an analogue network, each interface must contain electronics to, convert the outgoing bit stream to an analogue signal, and the incoming analogue signal to a bit stream. Depending on the type of electronics, 1 bps may occupy roughly, 1 Hz of bandwidth. At higher frequencies, many bits per Hz are possible using advanced modulation techniques.

### 3.5.5 Optical Fibre



Figure 1.31: Optical fibre

Fibre optic cable as shown in Figure 1.31 is made of fine strands of silicon glass fibre (thinner than a human hair), and is coated with a refractive surface. The signals are converted to light pulses before being sent. When light (provided by a laser or LED) is shown into the strand, it travels along the fibre strand (the refractive layer prevents it from escaping). Each fibre optic strand can support thousands of speech channels and multiple TV channels simultaneously. It is used for long haul telecommunications links, for providing high-speed data communications links for computers, and information services to homes (e.g., PAY TV).

Advantages of Fibre optic cable are:

1. high capacity (large bandwidth),
2. immune to interference (electromagnetic), and
3. can go long distances (low attenuation).

Its disadvantages are:

1. costly,
2. difficult to join, and
3. expensive to install and greater skill is required.

An Optical fibre transmission system has three components: the light source, the transmission medium, and the detector. Conventionally, a pulse of light indicates a 1 bit and the absence of light indicates a zero bit. The transmission medium is an ultra-thin fibre of glass. The detector is a photo-divider that generates an electrical pulse when light falls on it. By attaching a light source to one end of an optical fibre and a detector to the other, we have a unidirectional data transmission system that accepts an electrical signal, converts and transmits it by light pulses, and then reconverts the output to an electrical signal at the receiving end. Fibres can be connected in three different ways. First, they can terminate in connectors and be plugged into fibre sockets. Connectors lose about 10 to 20 percent of the light, but they make it easy to reconfigure systems.

Second, they can be spliced mechanically. Mechanical splices just place the two carefully cut ends next to each other in a special sleeve and clamp them together. The alignment can be improved by passing light through the junction and then making small adjustments to **maximise** the signal. Trained personnel can do mechanical splicing in 5 minutes, and show result in a 10 percent light loss.

Third, two pieces of fibre can be fused (melted) to form a solid connection. A fusion splice is almost as good as a single drawn fibre, but even here, a small amount of attenuation occurs. For all three kinds of splices, reflections can occur at the point of the splice, and the reflected energy can interfere with the signal.

### **3.5.6 Comparison between Optical Fibre and Copper Wire**

Optical fibre has many advantages over copper wire. The advantages are:

1. Optical fibre can handle much higher bandwidths than copper wire. Due to the low attenuation, repeaters are needed only about every 30 km on long lines, whereas, copper wires require repeaters every 5 km, which, is substantial sayings in cost. Optical fibre also has the advantage of not being affected by power surges, electromagnetic interference, or power failures. Neither, is it affected by corrosive chemicals in the air, making it ideal for harsh factory environments.
2. Optical fibre is lighter than copper. One thousand twisted pairs 1 km long weigh 8000 kg. Two fibres have more capacity and weigh only 100 kg, which greatly reduces the need for expensive mechanical support systems that must be maintained. For new routes, the installation cost of optical fibre is much lower than that for copper wire.

Finally, optical fibres do not leak light and are quite difficult to tap. This gives them excellent security against potential wire trappers.

The reason that optical fibre is better than copper wire is inherent in underlying physics. When electrons move in a wire, they affect one another and are themselves affected by electrons outside the wire. Photons in a fibre do not affect one another (they have no electric charge) and are not affected by stray photons outside the fibre.

**The disadvantages of optical fibre are:**

It is a complex technology requiring skills that most engineers do not possess. Since optical transmission is inherently unidirectional, two-way communication requires either two fibres or two frequency bands on one fibre. Fibre interfaces cost more than electrical interfaces.



### SELF ASSESSMENT EXERCISE 5

1. What is Analogue data transmission?
2. Explain the use of repeaters with respect to data transmission.
3. Describe the three categories of distortion.
4. List out the significance of delays in data transmission.

### 3.6 Wireless Transmission

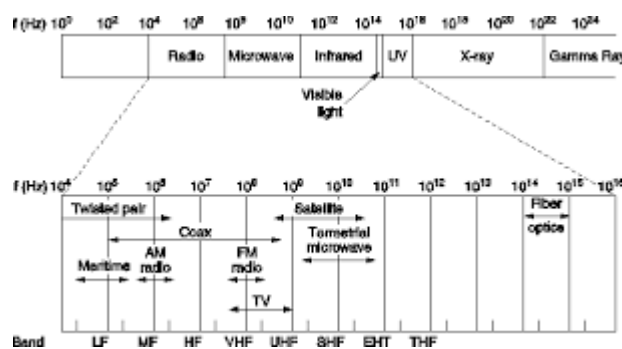

Figure 1.32: Frequency spectrum for Wireless Transmission

Wireless transmission is also called unbounded media. Here, there are no physical connectors between the two communicating devices. Usually the transmission is sent through the atmosphere, but sometimes it can be just across a room. Wireless media is used when a physical obstruction or distance blocks the use of normal cable media. The frequency spectrum for wireless transmission is shown in figure 1.32.

The three main types of Wireless Media are:

2. Radio wave,
3. Microwave, and
4. Infrared.

However, wireless also has advantages for fixed devices in some circumstances. For example, if running a fibre to a building is difficult due to the terrain (mountains, jungles, swamps, etc.) wireless may be preferable. It is noteworthy that modem



wireless digital communication began in the Hawaiian Islands, where large chunks of Pacific Ocean separated the users and the telephone system was inadequate.

### 3.6.1 Microwave Transmission



Figure 1.33: Microwave transmission station

Microwave is a radio system, which uses very high frequencies to send and receive data. Because of the high frequencies involved, microwave stations are located about 30 kilometres apart and in line of sight (visible to each other). An example of microwave transmission station is displayed in figure 1.33.

Microwave systems have sufficient bandwidth capacity to support a large number of voice channels and one or two TV channels.

Above 100 MHz, the waves travel in straight lines and can therefore, be narrowly focused upon. Concentrating all the energy into a small beam, using a parabolic antenna (like the familiar satellite TV dish) gives a much higher signal to noise ratio, but the transmitting and receiving antennas must be accurately aligned with each other. In addition, this directionality allows, multiple transmitters lined up in a row to communicate with multiple receivers in a row without interference. Before fibre optics, microwaves formed the heart of long-distance telephone transmission system.

Since, microwaves travel in straight lines, if, the towers are too far apart, the earth will get in the way. Consequently, repeaters are needed periodically. The higher the towers are, the further apart they can be. The distance between repeaters increases roughly, with the square root of the tower height. For 100-m high towers, repeaters can be spaced 80 km apart.

Unlike, radio waves at lower frequencies, microwaves do not pass through buildings **wall**. In addition, even though the beam may be well focused at the transmitter, there is still some divergence in space. Some waves may be refracted off low-lying atmospheric layers and may take slightly longer to arrive than, direct waves. The delayed waves may arrive out of phase with the direct wave and thus cancel the signal. This effect is called multipath fading and is often a serious problem. It is weather and frequency dependent. Some operators keep 10 percent of their channels idle as spares to switch on to when, multi path fading affects some frequency band temporarily.

In summary, microwave communication is so widely used for long- distance telephone communication, cellular telephones, television distribution, and other uses, that a severe shortage of spectrum has developed.

Microwave systems have the advantage of:

1. medium capacity,
2. medium cost, and
3. can go long distances.

Its disadvantages are:

1. noise interference,
2. geographical problems due to line of sight requirements, and
3. becoming outdated.

### **Comparison between Microwave and Optical Fibre**

The microwave has several significant advantages over optical fibre cable. The main one is that no right of way is needed, and by buying a small plot of ground every 50 km and putting a microwave tower on it, one can bypass the telephone system and communicate directly.

Microwave is also relatively inexpensive. Putting up two simple towers (may be just big poles with four guy wires) and putting antennas on each one may be cheaper than burying 50 km of fibre through a congested urban area or up over a mountain, and it may also be cheaper than leasing optical fibre from a telephone company.

### **Terrestrial Microwave**

Terrestrial Microwave employs Earth-based transmitters and receivers. The frequencies used are in the low-gigahertz range, hence, limiting all communication to line of sight.

Microwave transmissions are carried out using a parabolic antenna that produces an “arrow, highly directional signal. At the receiving site a similar antenna, which is sensitive to signals, only within a narrow focus, is placed. As both the transmitter and receiver are highly focused, they must be carefully adjusted so that, the transmitted signal is aligned with the receiver.

Microwave is frequently used as a means of transmitting signals where it would be impractical to run cables.

Terrestrial microwave systems operate in the low-giga hertz range, typically at 2-6GHz and 21-23GHz

Attenuation characteristics are determined by transmitter power, frequency and antenna size. Properly designed systems are not affected by attenuation under normal operational conditions. Rain and fog, however, can cause attenuation at higher frequencies.

Microwave systems might be vulnerable to electronic eavesdropping and signals transmitted through microwave are frequently encrypted.

### **Satellite Microwave**

Satellite Microwave systems relay transmission through communication satellites that operate in geosynchronous orbits (36,000 -40,000 km) above the Earth.

In order to communicate with satellites, the Earth stations use parabolic antennas. Satellites can retransmit signals in broad or in narrow beams depending on the locations that are to receive the signals. When the destination is on the opposite side of the earth, the first satellite must relay the signal through another satellite, as it cannot directly transmit to the receiver.

Satellite Microwave communication is possible with most remote sites and with mobile devices as no cables are required. Ships at sea and motor vehicles also use Satellite Microwave communication.

As all signals must travel 36,000 miles to the satellite and 36,000 miles when returning to the receiver, the time required to transmit a signal is independent of the distance. The time required for the signal to arrive at its destination is called

propagation delay. The delay encountered with satellite transmissions is about 0.5 seconds.

Satellite Microwave communication is extremely expensive, as a result of which, organisations share the cost or they purchase services from a commercial provider.

Satellite links operate in the low-giga hertz range, typically at 4-6 GHz. Attenuation depends on transmitter power, frequency and atmospheric conditions. Rain and atmospheric conditions may cause attenuation at higher frequencies.

Signals transmitted through Satellite Microwave are usually encrypted.

### **3.6.2 Radio Transmission**

The radio portion of the electromagnetic spectrum extends from 10KHz to 1GHz. Within this range there are numerous bands or ranges of frequencies that are designated for specific purposes. Some of the familiar frequency bands are:

Short wave, VHF (Very High Frequency) used for television and FM radio, and UHF (Ultra High Frequency) used for television.

Radio waves are easy to generate, can travel long distances, and penetrate buildings easily, so they are widely used for communication, both indoors and outdoors. Radio waves also are omni directional, meaning that they travel in all directions from the source, so that the transmitter and receiver do not have to be carefully aligned physically and that the signal can be received by all the radios within the broadcast area.

The properties of radio waves are frequency dependent. At low frequencies, radio waves pass through obstacles well, but the power falls off sharply with distance from the source, roughly as  $1/r^3$  in air. At high frequencies, radio waves tend to travel in straight lines and bounce off obstacles. They are also absorbed by rain. At all frequencies, radio waves are subject to interference from motors and other electrical-equipment.

### **3.6.3 Infrared and Millimetre Waves**

Unguided infrared and millimetre waves are widely used for short-range communication. The remote controls used on televisions, **Video Cassette Recorder (VCR's)**, and stereos all use infrared communication. The remote control transmits pulses of infrared light that carry coded instructions to the receiver on the TV. They are relatively directional, cheap, and easy to build, but they have a major drawback, that is, they do not pass through solid objects (try standing between your remote control and your television and see if it still works). In general, as we go from long-wave radio toward visible light, the waves behave more and more like light and less and less like radio.

Infrared waves do not pass through solid walls well, as a result of which, an Infrared system in one room of a building, will not interfere with a similar system in adjacent rooms, which is a great advantage. Due to this nature, security of infrared systems against eavesdropping is better than that of radio systems. Because of these reasons,

no government license is needed to operate an infrared system, in contrast to radio systems, which must be licensed.

These properties have made infrared suitable for indoor wireless LANs. For example, the computers and offices in a building can be equipped with relatively unfocused (i.e., somewhat omni directional), infrared transmitters and receivers. In this way, portable computers with infrared capability can be on the local LAN without having to physically connect to it. During a meeting where several people use their portables, they can just sit down in the conference room and be fully connected, without having to plug in. Infrared communication cannot be used outdoors because the sun shines as brightly in the infrared as in the visible spectrum.

Two methods of infrared networking that are in use are:

1. Point-to-point and Broadcast Infrared
2. Point-to-point

The **Point-to-point networks** operate by relaying infrared signals from one device to the next. Hence, transmissions are focused on a narrow beam, and the transmitter and receiver must be aligned carefully. Point-to-point infrared is not suitable for use with devices that move frequently because, here, the devices must be carefully aligned and setup.

High power laser transmitters can be used in order to transmit data for several thousand yards when the line of sight communication is possible.

The cost of **Point-to-point infrared** equipment is higher than the cost for a comparable cabled network. When systems use transmitters that are based on LED technology and hardware cost is moderate, but, when long distance systems use high powered laser transmitters then the cost is very high.

Infrared devices are insensitive to radio frequency interference, but, the reception can be degraded by bright light. As the transmitters are tightly focused, they are fairly immune to electronic eavesdropping.

### **Broadcast Infrared**

Broadcast infrared disperses transmissions so that, they are visible to several receivers. The two possible approaches to broadcast infrared networking are:

1. The active transmitter can be located at a high point so that, it can transmit to all devices.
2. A reflective material can be placed on the ceiling. Devices transmit toward the ceiling, from where, the light signals are dispersed to other devices in the room.

Installation is simple as device alignment is not critical. Hence, it is essential that each device has clear transmission and reception pathways. As all devices are sensitive to light interference, during installation, the control of ambient light is very important.

### 3.7 Wireless LAN

Wireless LAN's are systems of portable computers that communicate using radio transmission. Wireless LAN's make use of the omni directional wireless communication.

The main objective of wireless LAN is to provide high-speed communication among computers that are located in relatively close proximity.

Wireless LAN's are usually configured in an office building with the base stations strategically placed around the building. Optical fibre cable can be used to cable all base stations together. If the transmission power of the base stations and portables is adjusted to a range of 3 or 4 meters, then, each room acts as a single cell, and the entire building acts as a large cellular system. Here unlike the cellular telephone system, each cell has only one channel that covers the entire bandwidth, which is available. Typically, its bandwidth is 1 to 2 Mbps.

The disadvantages of using Radio transmitters are:

When the receiver is within the range of two active transmitters, the resulting signal will usually be grabbed and hence, useless.

In indoor wireless LAN's, the presence of walls between the stations have great impact on the effective range of each station.



## 4.0 CONCLUSION

In this unit you have learned about the concept of transmission terminology as well as the different types of data transmission. Also, you have learned about the various types of transmission media and their particular characteristics. It is believed that by how you should be able to choose a suitable transmission media for your particular network.



## 5.0 SUMMARY

In this unit, we have studied, the basic concepts of Data Transmission. To start with, we discussed the basic terms that are frequently used in Data transmission like Bandwidth, frequency, channel, baud etc. Bandwidth is the amount of data or signals that a transmission media can carry in a fixed amount of time and its unit of measurement is bits per second (bps) for digital signal and Hertz (Hz) for analogue signals. Frequency is the number of cycles or periods that a signal completes within one second and its unit of measurement is Hertz (Hz). Channel refers to the communication path between the source and destination.

As it is essential to know how data can be transmitted from the source to the destination, the different modes of data transmission were outlined as follows:

1. Parallel and Serial communication.
2. Asynchronous, Synchronous and Isochronous communication.

### 3. Simplex, Half duplex and Full duplex communication.

We also discussed the two major types of signals that is Analogue and Digital and, the manner in which these two types of signals can be transmitted from the source to the destination.

When, data is transmitted from the source to the destination, there is, always a scope for transmission errors and the data may not reach in exactly the same form as it was sent. We have seen that these transmission errors are classified into three main categories that is Delay distortion, Attenuation and Noise. Delay distortion is caused because, signals at different frequencies, travel at different speeds along the transmission medium. As the signal travels along the transmission medium, its strength decreases over distance, this is known as Attenuation. Usually, some unwanted electromagnetic energy gets inserted during the course of transmission and this is called Noise. The concept of Delays and how to reduce them were also discussed.

We have seen that transmission media can be classified in to two categories, that are, guided media and unguided media. The guided media uses physical cable for data transmission. Twisted pair, co-axial cable and optical fibre are the three main types of guided media; they differ in their physical characteristics as well as transmission capacities. In case of unguided media, the transmission medium is air. Unguided media can be Radio, Microwave or Infrared. Security is a major concern when using unguided media for transmission.

Towards the end, Wireless LAN's were also discussed. Here, we saw that Wireless LAN's make use of Radio transmission and their main objective is to provide high speed communication among computers that are located in relatively close proximity. In the next unit, we will be studying, the different Data encoding and communication techniques.



## 6.0 TUTOR MARKED ASSIGNMENT 2

1. Discuss the twisted pair cable.
2. Describe co-axial cable and its uses.
3. Describe the structure of optical fibre and list its advantages and disadvantages.
4. Explain how Radio communication differs from Satellite communication.
5. Explain the working of Wireless LAN's.



## 7.0 REFERENCES/FURTHER READINGS

Andrew. S. Tannenbaum, *Computer Networks*, PHI, New Delhi.

William Stalling, *Data and Computer Communication*, PHI, New Delhi.

## 8.0 ANSWERS TO SELF-ASSESSMENT EXERCISES 4



### **Question 1**

What is data communication?

### **Solution**

This is the processing of transferring of data from sender to receiver through transmission media such as a cable irrespective of the geographical location.

### **Question 2**

Explain the term bandwidth. Why is bandwidth useful?

### **Solution**

Bandwidth is the highest rate of transfer of data through a channel. It is the difference between the lower band and the upper band of a channel.

It is very useful to determine how quick a web page loads on a browser.

### **Question 3**

Table 1.4: Compares of parallel and serial transmission method

S/N	Serial Transmission	Parallel Transmission
1.	Data flows in both directions	Data flows through many lines
2.	It is cost effective	It is not cost effective
3.	One bit of data is sent at the rate of one per clock pulse	Eight bit of data are sent at the rate of one per clock pulse
4.	Slower than parallel transmission	Faster than serial transmission
5.	Used in most cases to transfer data over a long distance	Used to transfer data over short distance
6.	Used simplex circuit to transmit data	Used complex circuit to transmit data

### **Question 4**

Give reasons as to why full duplex is more challenging than simplex and half duplex transmission

### **Solution**

Full duplex is more challenging than simplex and half duplex transmission because it allows two ways traffic simultaneously which gives it double utilization of the bandwidth. This however, leads to better performance of the full duplex transmission.

### **Question 5**

Bring out the difference between synchronous, Asynchronous and Isochronous transmission.



## **Solution**

Synchronous system transmits data continuously without start and stop bits between the successive data items. Asynchronous system transmits data with some delay emanating from the start and stop bit between any two successive data items. While Isochronous system ensure transmission of data at a fast speed without the rigidity of synchronous system with a stable gap in the midst of sending consecutive data items.

## **9.0 ANSWERS TO SELF-ASSESSMENT EXERCISES 5**

### **Question 1**

What is analogue data transmission?

### **Solution**

This is a method of sending information with the use of a continuous signal which changes in amplitude, phase or other attributes in consonance to that information

### **Question 2**

Explain the use of repeaters with respect to data transmission

### **Solution**

A repeater is a device us to boosting signal in transmission to guide against attenuation. The amplification of the signal with the help of repeater alters the signal to travel a long distance without signal degradation.

### **Question 3**

Describe the three categories of distortion

### **Solution**

the three categories of distortion are:

1. Attenuation
2. Delay distortion
3. Noise

**Attenuation** is the loss of energy as the signal travel along a channel.

**Amplifiers** are used to boost the signal to come back to its original strength.

**Delay** is distortion is a process whereby signal of different frequencies travel with diverse speed along the channel. This implies that all signals will get to the destination at the same time. Thus, leading to distortion of the signal.

### **Question 4**

List out the significance of the delay in data transmission

### **Solution**

The significance of delay in data transmission are:

- a. It has a list of impact in determining the selection and rendition of network algorithms such as routing and flow control.
- b. A substantial delay is catastrophic to data transfer.

## **9.0 ANSWER TO TUTOR MARKED ASSIGNMENT 2**

### **Question 1**

Discuss the twisted pair cable.

### **Solution**

Twisted pair cable is a copper wire that links diverse nodes such as linking computers in the home to those of the business offices. Twisted pair may be shielded (i.e shielded twisted pair) with the acronym STP or not shielded (unshielded twisted pair) with the acronym UTP. STP is common with the installation of the old telephone networks to guide against crosstalk and reduce electromagnetic radiation. Twisted pair are twisted to guide against signal interference. The bandwidth hinge on the thickness of the wire and the distance it goes. They are less costly and easy to install.

### **Question 2**

Describe co-axial cable and its uses.

### **Solution**

Coaxial cable is made up of a tube of electronically conveying substances encircling a central conductor clench in place by insulator. It is used for transmission of signal such as telegraph, telephone, television and Internet signals.

### **Question 3**

Describe the structure of optical fibre and list its advantages and disadvantages

### **Solution**

Optical fibre is cable used to send data via fibres (threads) or plastic (glass). This comprises pack of glass fibre which sends regulated messages over light waves. They advantages are:

- a. It has higher bandwidth than the copper cables
- b. It gives room for transmission of data for a longer kilometre coverage at less loss.
- c. The optical cable hinders electromagnetic blockages.
- d. Fibre cable is better than copper wire 4.5 times in size.
- e. Fibre cable fill less area when liken to copper wires and they are lighter and thinner.

- f. The installation is easy due to less weight.
- g. The security is high when conveying data and are very difficult to tap since they don't give rise to electromagnetic energy.

The disadvantages are:

- a. It is difficult join optical fibre cables since the beam could be lost while scattering.
- b. Unique equipment are often needed for the installation
- c. Fibre optic cable is delicate when fitting it since the cable are compact
- d. Copper wires are not delicate as fibre optic cables
- e. Expertise and unique devices are needed to maintain and check the transmission of fibre cables.

#### **Question 4**

Explain how Radio communication differs from satellite communication

#### **Solution**

Satellite communication is the use of artificial satellite to connect varied places of the earth for the purpose of communication. There are more than 2,000 analogues of digital satellite moving along the earth orbit conveying voice, video and data from one place to the other globally.

Radio communication on the other hand is the conveying of signal and connecting one place to the other using radio waves. Radio wave consist of electromagnetic waves which has frequency ranging from 30hertz (Hz) and 300gigahertz (GHz).

The differences between radio communication and satellite communication are that the:

- a. Frequency used by satellite is higher and more powerful than the radio wave. It gives contraction of all obtainable power into a narrow beam. This reduces bandwidth and gives more bandwidth for transmission.
- b. Narrow beam are well focused and point t one direction. That is, it points at the exact location of the antenna while radio station broadcast in all directions.

#### **Question 5**

Explain the working of wireless LAN

#### **Solution.**

Wireless LAN (WAN) is a mechanism that gives room for wireless communication. WLAN links one place to the other via Wifi instead of Ethernet devices. It sends data over the air with the assistance of one of the 802.11 protocols of IEEE while LAN sends data over physical cables in a sequence of Ethernet packets.



## UNIT 3 DATA ENCODING AND COMMUNICATION TECHNIQUE

### CONTENTS

- 1.0 Introduction
- 2.0 Objectives
- 3.0 Main Content
  - 3.1 Encoding
  - 3.2 Analogue to Analogue Modulation
  - 3.3 Analogue to Digital Modulation
  - 3.4 Digital to Analogue Modulation
  - 3.5 Digital to Digital Encoding
- 4.0 Conclusion
- 5.0 Summary
- 6.0 Tutor-Marked Assignment
- 7.0 References/Further Readings



### 1.0 INTRODUCTION

You might be aware from the description in the previous blocks, how data is transmitted through a channel (wired or wireless) in the form of an analogue or digital signal. In this unit, we will elaborate on the techniques to produce these types of signals from analogue or digital data. We will look at, in brief, on the following encoding techniques [Figure 1]:

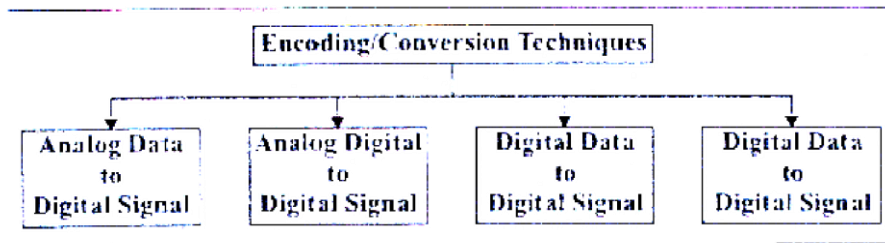

Figure 1.34: Encoding/Conversion Techniques

1. Analogue data as an analogue signal
2. Analogue data as a digital signal
3. Digital data as an analogue signal
4. Digital data as a digital signal

We will confine ourselves to a treatment of the most useful and common techniques only, and will skip over the many other kinds of encoding of data that can be performed.



### 2.0 OBJECTIVES

After going through this unit, you should be able to describe:

1. what encoding means
2. why encoding is needed
3. some different types of encoding
4. mechanisms and techniques used for encoding
5. when each type of encoding is used with examples.

There are several other types of encoding as well as encoding techniques that will not be discussed in this unit.



## 3.0 MAIN CONTENT

### 3.1 Encoding

Sleekly, we cannot lend a signal containing information directly over a transmission medium, at least not for long distances. For example, the sound of our voice can only travel a few hundred meters. If we want to send our voice to the next city, we have to be able to transform our voice, to, aft electrical signal that can then, be sent that long distance. Then, we would also need to perform the reverse conversion at the other end.

So, we see that, to send a signal over a physical medium, we need to encode or transform the signal in some way so that the transmission medium can transmit it. The sender and the receiver must agree on what kind of transformation has been done so that it can be reversed at the other end and the actual signal or information can be recovered. The information content in a signal is based upon having some changes in it. For example, if we just send a pure sine wave, where the voltage varies with time as a sine function, then, we cannot convey much information apart from the fact that there is some entity at the other end that **is** doing the transmitting.

The information content of a signal is dependent on the variation in the signal. After sending one cycle of a sine wave there is no point in sending another cycle because we will not be able to convey anything more than what we have already done. What is needed is to modify the sine wave in some way to carry the information we want to convey. This is called modulation.

You know that there are two kinds of signals: analogue and digital. Likewise, there are two types of information that we may want to transmit, again analogue and digital. So, we get four basic combinations of encoding that we may need to perform, depending on the signal type as well as the information type. We shall look at each of these four types briefly in this unit and will also study the ways in which the actual encoding can be done.

### 3.2 Analogue- To-Analogue Modulation

Let us first look at a situation where our signal and information are both of the analogue type. The act of charging or encoding the information in the signal is known as modulation. A good example of such encoding is radio broadcasting. Here we primarily want to send sound in some form over the atmosphere to the receiving radio gets. The sound is converted into an analogue electrical signal at the source and

is used to encode the signal which is the base frequency at which the transmission is being done. The reverse process is performed at the radio set to recover the information in electrical form, which is then converted back to sound so that, we hear what was being said at the radio station.

Let us, formulate another definition of modulation. When a low frequency information signal is encoded over a higher frequency signal, it is called modulation [Ref.3]. The encoding can be done by varying amplitude (strength of a signal), period (amount of time, in seconds, a signal needs to complete a cycle) and frequency (number of cycles per second) and phase (position of waveform relative to zero).

Notice the simulations of the word modulation to the word modifying. For instance, an audio signal (one that is audible to human ear) can be used to modify an RF (Radio Frequency) carrier, when the amplitude of the RF is varied according to the changes in the amplitude of the audio, it is called amplitude modulation (AM), and when the frequency is varied, it is called FM (frequency modulation).

Although, it can be dangerous to use analogues as they can be carried too far, we can understand this process with an example. Suppose we want to send a piece of paper with something written on it to a person a hundred meters away. We will not be able to throw the paper that far. So, we can wrap it around a small stone and then throw the stone towards the person. He can then unwrap the paper and read the message. Here, the stone is the signal and the piece of paper is the information that is used to change the stone. Just as sending the stone alone would not have conveyed much to our friend, similarly sending only the base signal (also called carrier signal) will not convey much information to the recipient.

Therefore, there are three different ways in which this encoding of the analogue signal with analogue information is performed. These methods are:

**Amplitude modulation (AM)**, where the amplitude of the signal is changed depending on the information to be sent (Figure 1.35)

**Frequency modulation**, where the frequency of the signal is changed depending on the information to be sent (Figure 1.36)

**Phase modulation**, where it is the phase of the signal that is changed according to the information to be sent (figure 1.37).

## **Amplitude Modulation**

Now, let us go into the details. In this type of modulation, the frequency and phase of the carrier or base signal are not altered. Only the amplitude changes and we can see that the information is contained in the envelope of the carrier signal. It can be proud/demonstrated that, the bandwidth of the composite signal is twice that of the highest frequency in the information signal that modulates the carrier.

By international agreement, for radio transmission using AM, 9 KHz is allowed as the bandwidth. So, if a radio station transmits at 618 KHz, the next station can only transmit at 609 or at 627 KHz. It will be clear that the highest audio frequency that can be carried over AM radio is thus 4.5 KHz, which is sufficient for most voice and

musical pieces. Actually, the modulating signal is **centred** around the carrier frequency and extends the composite signal both ways in equal measure. Each of these is called a sideband and therefore, AM radio transmission is dual sideband. This is actually wasteful because the spectrum is unnecessarily used up, but the cost and complexity associated with eliminating one sideband, and performing single sideband AM modulation, have led to the technique not being used widely.

AM radio transmission has been assigned the frequency range of 530 to 1700 KHz. The quality of AM transmission is not very good as noise in the channel (the atmosphere, here) can easily creep into the signal and alter its amplitude. So, the receiving end will likely find a fair amount of noise in the signal, particularly at higher, short wave frequencies. That is why you often get a lot of static in short wave or even medium wave broadcasts.

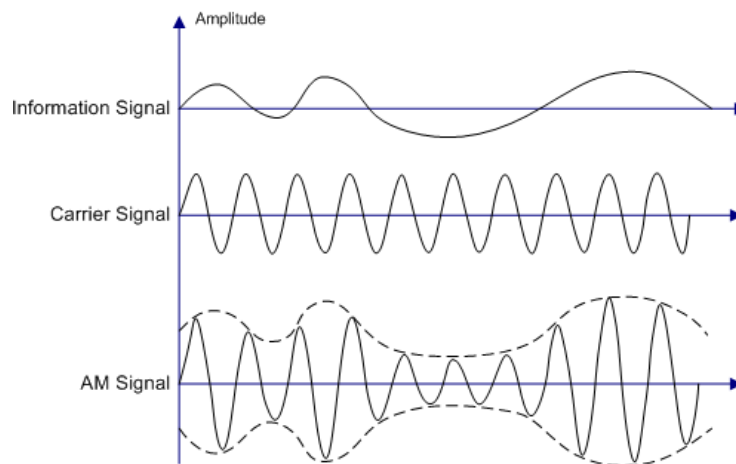

AM Bandwidth

**Figure 1.35:** Amplitude modulation

## Frequency Modulation

In contrast to Amplitude Modulation, here it is the frequency of the base signal that is altered depending on the information that is to be sent. The amplitude and phase of the carrier signal are not changed at all. It can be shown that this results in a bandwidth requirement of 10 times the modulating signal, centred on the carrier frequency.

This method is the less susceptible to noise and gives the best performance of all data encoding types as far as the quality of the transmitted signal is concerned. Although digital encoding methods may give better performance over multiple hops (because in their case, the original signal can be accurately reconstructed at each hop), Frequency Modulation (PM) is the best as far as single hop transmission goes.

FM radio transmission has been allocated the spectrum range 88 MHz to 108MHz. As a good stereo sound signal needs 15KHz of bandwidth, this means that PM transmission has a bandwidth of 150KHz. To be safe from interference from neighbouring stations, 200KHz is the minimum separation needed. As a further safety measure, in any given area, only alternate stations are allowed and the



neighbouring frequencies are kept empty. This is practical because PM transmission is line of sight (because of the carrier frequency) and so, beyond a range of about 100Km or so, the signal cannot be received directly (this distance depends on various factors). We can therefore, have the most 50 FM stereo radio stations in a given geographical area.

As in the case of AM transmission (having 2 sub-bands), PM also has multiple sidebands maybe two or more, which is really wasteful but is tolerated in the interests of simplicity and cost of the equipment.

In television transmission the bandwidth needed is 4.5 MHz in each sideband. The video signal is sent using amplitude modulation. The audio signal goes at a frequency that is 5.5 MHz over the video signal and is sent as a frequency modulated signal. To reduce the bandwidth requirement, the video signal is sent using a method called vestigial sideband that needs only 6 MHz, instead of the 9 MHz that would have been needed for dual sideband transmission, though, it is more than the 4.5 MHz that a pure single sideband transmission would have needed.

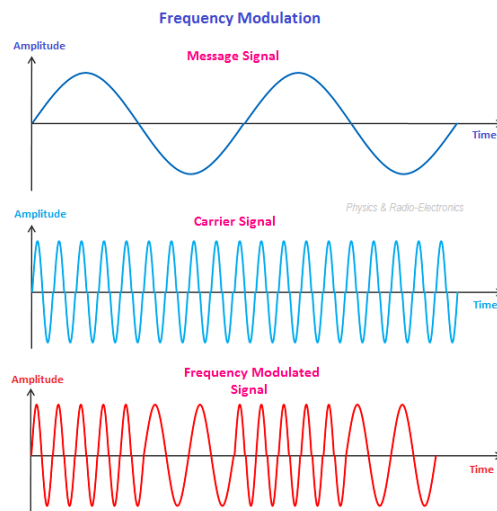

Figure 1.36: Frequency modulation

## Phase Modulation

As you would have guessed by now, in Phase Modulation (PM) the modulating signal leaves the frequency and amplitude of the carrier signal unchanged but alters its phase. The characteristics of this encoding technique are similar to FM, but the advantage is that of reduced complexity of equipment. However, this method is not used in commercial broadcasting.

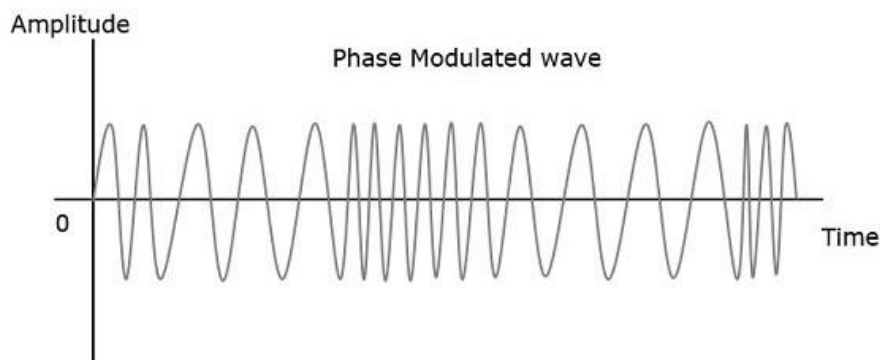

Figure 1.37: Phase Modulation



### SELF-ASSESSMENT EXERCISE 6

1. Why do we need modulation? Would it be right to simply send the information as the signal itself?
2. A common FM broadband has a derivation of  $\pm 75\text{kHz}$  bandwidth and a modulation frequency of  $15\text{kHz}$ . Calculate the bandwidth of 98% of the power.
3. Why is AM the most susceptible to noise, of the three types of modulation?

### 3.3 Analogue to Digital Modulation

Natural phenomena are analogue in nature and can take on any of the potentially infinite number of values. For example, the actual frequencies contained in a sound made by a human is an analogue signal, as is the amplitude or loudness of the sound. One example of coding analogue data in digital form is when, we want to record sound on digital media such as a **Digital Video Disk (DVD)** or in other forms such as **Moving Picture Expert Group Audio Layer-3 (MP3)** or as a **Waveform Audio File Format “.wav”** file. Here, the analogue signal, that is, the musical composition or the human voice is encoded in digital form. This is an example of analogue to digital encoding.

While, in the case of analogue to analogue encoding, the motivation was to be able to transmit the signal for long distances, here, the main reason is to be able to change the information itself to digital form. That digital signal can then be transmitted, if necessary, by any suitable method.

One method of encoding is what is called Pulse Code Modulation (PCM). This gives very good quality and when used in conjunction with error correction techniques, can be regenerated at every hop on the way to its final destination. This is the big advantage of digital signals. At every hop, errors can be removed and the original signal reconstructed almost exactly, barring the few errors that could not be corrected.

The first step in PCM is, to convert the analogue signal into a series of pulses (**Figure 1.32**). This is called Pulse Amplitude Modulation (PAM). To do this the analogue signal is sampled at fixed intervals and the amplitude at each sample decides the amplitude of that pulse. You can see that at this step, the resulting signal is still actually an analogue signal because the pulse can have any amplitude, equal to the amplitude of the original signal at the time the sample was taken. In PAM, the sampled value is held for a small time so that the pulse has a finite width. In the original signal the value occurs only for the instant at which it was sampled.

One question that arises here is, how many samples do we have to take? We would not want to take too many samples as that would be wasteful. At the same time, if, we take too few samples, we may not be able to reconstruct the original signal properly. The answer comes from Nyquist's theorem, which states that, to be able to

get back the original signal, we must sample at a rate, that is, at least twice that of the highest frequency contained in the original signal.

Let us do some calculations to see what this means in practice. In the next unit, you will see that a voice conversation over a telephone has a range of frequencies from 300 Hz to 3300 Hz. Because the highest frequency is 3300 Hz, we need at least 6600 samples a second to digitize the voice to be sent over a phone line. For safety we take 8000 samples per second, corresponding to a sampling interval of 125 microseconds.

The next stage in the digitization of the signal is quantization. In this process, the analogue values of the sampled pulses are quantized, that is, converted into discrete values. For example, if the original analogue signal had an amplitude ranging from +5v to -5v, the result of PAM might be to produce pulses of the following amplitudes (each sample is taken at say, intervals of 125 microseconds)

+4.32, +1.78, -3.19, -4.07, -2.56, +0.08 and so on.

In quantization, we may decide to give the amplitude 256 discrete values. So, they will range from -127 to +128. The actual amplitude of +5v to -5v has to be represented in this range, which means each value is of 39 mV nearly. By this token, the first value of +4.32v lies between 110 and 111, and we can decide that such a value will be taken as 110. This is quantization. The analogue values now become the following quantized values:

110, 45, -81, -104, -65, 2 and so on.

The above discrete value~ are now represented as 8 binary digits with, 1 bit giving the sign while the other 7 bits represent the value of the sample.

In the final stage of the encoding, the binary digits are then transformed into a digital signal using any of the digital to digital encoding mechanisms discussed later in this unit. This digital signal is now the representation of the original analogue signal.

PCM is commonly used to transmit voice signals over a telephone line. It gives good voice quality but, is a fairly complex method of encoding the signal. There is a simpler method that can be used, but we have to pay the price in terms of the lower quality of the encoded signal. This is called Delta modulation. Here, samples are taken as described above, but instead of quantising them into 256 or more levels, only the direction of change is retained. If the sample is larger in value than the previous one, it is considered a 1 while otherwise it is considered a 0 bit. So the sequence above would be encoded as:

1,0,0,0,1,1 and so on.

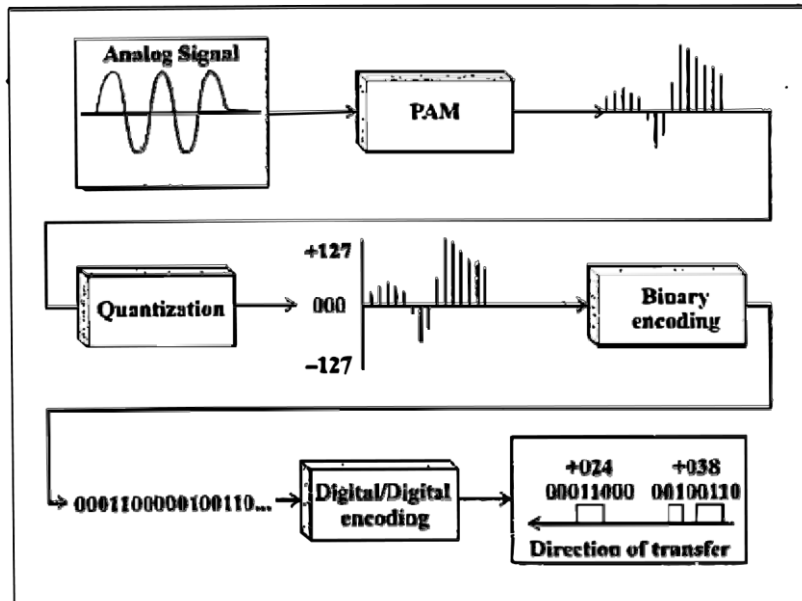

Figure 1.38 : Pulse Code Modulation

### 3.4 Digital to Analogue Modulation

So far, we have looked at the codification of analogue data, where the source information could take up any value. We also have need for the reverse type of encoding, where binary digital values have to be encoded into an analogue signal. This may seem simple because after all, we only have to give two distinct values to the analogue signal, but here you need to **realise** that, we have to be able to distinguish between successive digital values that are the same, say three 1 's in succession or two 0's in succession. These should not get interpreted as a single 1 or a single 0! This sort of problem did not exist in the case of analogue to analogue encoding.

One example where such encoding is needed is, when we need to transmit between computers over a telephone line. The computers generate digital data, but the telephone system is analogue. So, this situation is a bit different from the transmission of voice over the telephone, where the source signal is also analogue.

In this kind of encoding, one important factor of interest is the rate at which we can transfer bits. Clearly, there will be some kind of limit to the amount of information that we can send in a given time. This depends on the available bandwidth of the carrier signal, that is, the variation that we can permit around the nominal frequency as well as on the specific technique of encoding that we use.

Here it is important to understand two aspects of the rate of transfer of information. The first is the bit rate that tells us the number of individual bits that are transmitted per second. The second, and more important from the transmission angle, is the baud rate. This is the number of signal transitions per second that are needed to represent those bits. For a binary system, the two are equal. In general, the bit rate cannot be lower than the baud rate, as there has to be at least one signal transition to represent a bit.

We have seen in analogue to analogue encoding that, the source signal modulates the base or carrier signal to convey the information that we want to transmit. A similar principle is also used in digital to analogue encoding. The carrier signal has to be modulated, but this time by the digital signal, to produce the composite signal that is transmitted. However, while in the analogue case there were a potentially infinite number of values that could have been transmitted, here we have only two values (a 0 or a 1) that will modulate the signal.

If, there is no modulation, the carrier signal will be a pure sine wave at the frequency of transmission. You will realise that the baud rate that can be supported also depends on the quality of the line and the amount of random noise that is present in the medium. Like in analogue-to-analogue encoding, there are three properties of the sine wave that we can alter to convey information. These are the amplitude, the frequency and the phase. In addition, we can also use a combination of amplitude and phase change to encode information more efficiently. Modulation is also referred to as shift keying in this type of encoding technique.

There are three types of digital to analogue modulation (Figure 1.39)

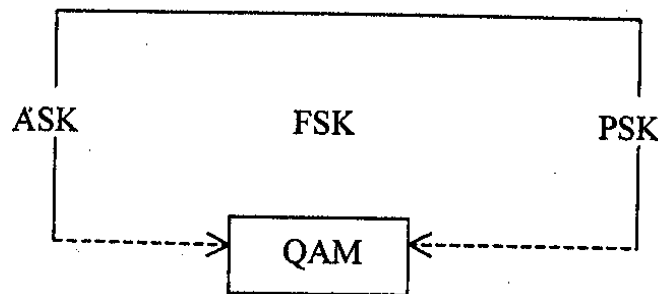

Figure 1.39; digital to analogue modulation techniques

Now we will take up each one individually.

### Amplitude Shift Keying (ASK)

In this kind of encoding, abbreviated as ASK, the amplitude of the analogue signal is changed to represent the bits, while the phase and the frequency are kept the same. The bigger the difference between the two values, the lower the possibility of noise causing errors. There is no restriction, however, on what voltage should represent a 1 or a 0, and this is left to the designers. For the duration of a bit, the voltage should remain constant.

One method could be to represent the high voltage as a 1 and the negative high voltage as a 0, although the reverse convention could also be used. Sometimes, to reduce the energy needed for transmission, we can choose to represent a 0 or a 1 by a zero voltage, and the other bit by the high voltage. This scheme is called on-off-keying (OOK).

Alternative, binary 1 can stand for a short pulse of light and binary 0 can stand for light out. Again, low level light emitted by laser transmitter in most cases have a fixed “bias” which stands for 0. On the other hand, a higher amplitude light wave stands for binary 1. Figure 3.5b displays an ASK.

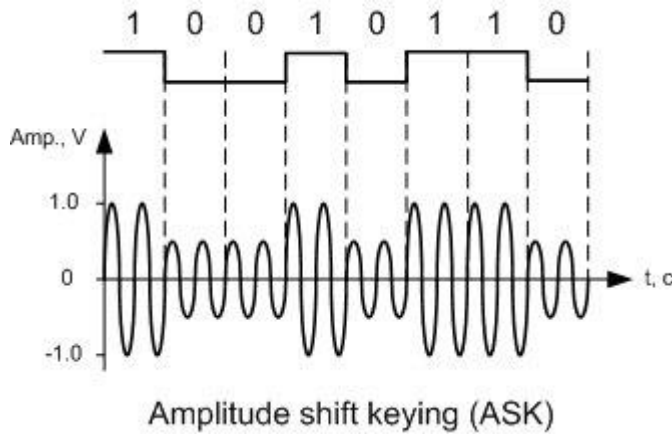

Figure 1.40: Amplitude Shift Keying.

Like amplitude modulation in the analogue case, ASK is vulnerable to noise. Amplitude changes easily as a result of the noise in the line, and if, the quantum of noise **distortions, propagation conditions on diverse route in PSTN etc** is great enough, it can result in an error. This would mean that a 0 gets interpreted as a 1 at the receiving end, or vice versa. Noise can occur as spikes or as a constant voltage that shifts the amplitude of the received signal. Even thermal noise, that is fairly constant, can cause a 0 to be interpreted as a 1 or the other way round.

To find the bandwidth requirement of an ASK encoded signal on an ideal, noiseless, line, we have to do a Fourier analysis of the composite signal. This yields harmonics on either side of the carrier frequency, with frequencies that are shifted by an odd multiple of half the baud rate. As most of the energy is concentrated in the first harmonic, we can ignore the others. It can then be shown that the bandwidth required for ASK encoding is equal to the baud rate of the signal. So if we want to transfer data at 256 Kbps, we need a bandwidth of at least 256 KHz. In a practical case, there will be noise in the line and this ideal cannot be achieved. This increases the bandwidth requirement by a factor that depends on the line quality and the carrier amplitude. ASK is a simple encoding method but is not commonly used by itself because of efficiency and quality issues.

### Frequency Shift Keying (FSK)

Just as in the case of analogue to analogue encoding, we can encode a digital signal by changing the frequency of the analogue carrier. This is frequency shift keying (FSK). When a bit is encoded, the frequency changes and remains constant for a particular duration. The phase and the amplitude of the carrier are unaltered by FSK. Just as in FM, noise in the line has little effect on the frequency and so, this method is less susceptible to noise.

It is possible to show that an FSK signal can be analysed as the sum of two ASK signals. One of these is centred around the frequency used for a 0 bit and the other for the frequency used for a 1 bit. From this, it is easy to show that the bandwidth needed for an FSK signal is equal to the sum of the baud rate and the difference between the two frequencies. Thus, the requirement of FSK is a higher bandwidth that helps us to avoid the noise problems of ASK. **Figure 1.41 displays a FSK.**

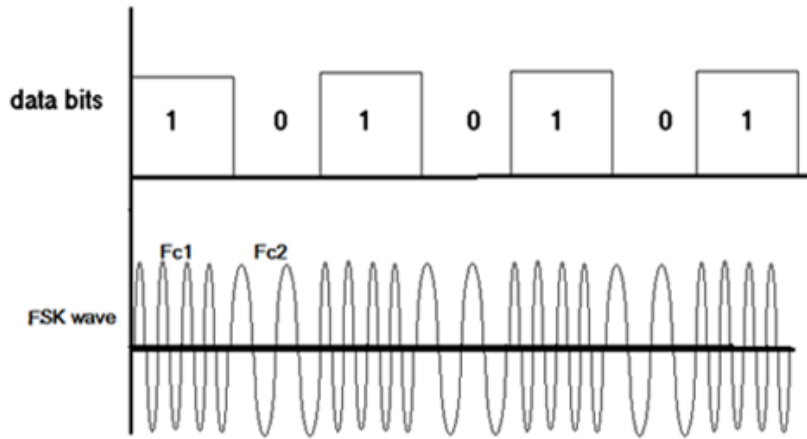

Figure 1.41: Frequency Shift Keying

FSK is not much used in practice because of the need for higher bandwidth and the comparative complex requirement for changing the frequency.

### Phase Shift Keying (PSK)

We can also encode by varying the phase of the carrier signal. This is called phase shift keying (PSK) and here, the frequency and amplitude of the carrier are not altered. To send a 1 we could use a phase of 0 while we could change it to 180 degrees to represent a 1. Such an arrangement is not affected by the noise in the line, because that affects amplitude rather than the phase of the signal.

This quality of PSK can be used to achieve more efficient encoding. For example, instead of having only 2 phases, we could have four phases, 0, 90 degrees, 180 degrees and 270 degrees as shown in figure 1.42. Each of these phase shifts could represent 2 bits at one go, say, the combinations 00, 01, 10 and 11 respectively. Such a scheme is called 4-PSK. The concept can be extended to higher levels and we could have 8-PSK to send groups of 3 bits in one go as shown in figure 1.43. This method can be extended further, but at some point the sensitivity of the communication equipment will not be enough to detect the small phase changes and we are then limited for that reason.

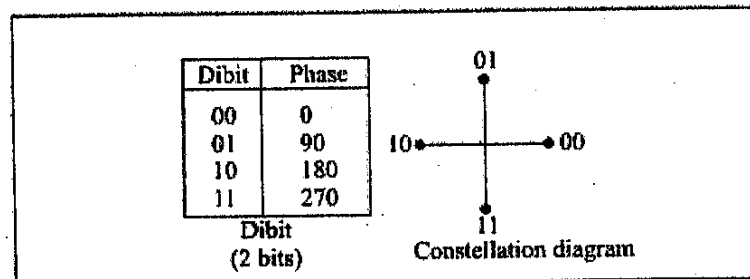

Figure 1.42: 4 PSK



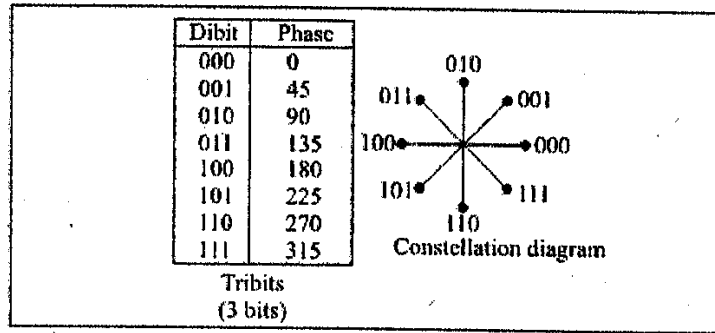

Figure 1.43: 8 PSK

Clearly, the scheme is more efficient than ASK because, we can now achieve a higher bit rate from the same bandwidth. It can be shown that the bandwidth required in 2-PSK is the same as that needed in ASK. But the same bandwidth at 8-PSK can transmit thrice the number of bits at the same baud rate.

Why can we not apply the same trick in ASK? We could have 4, 8 or more amplitude levels to transmit 2, 3 or more bits in one signal transition. The reason is that, ASK is vulnerable to noise and that makes it unsuitable for using many different amplitude levels for encoding. Similarly, FSK has higher bandwidth requirements and so we do not use this kind of technique there as, there is not much to be gained.

### Quadrature Amplitude Modulation (QAM)

To further improve the efficiency of the transmission, we can consider combining different kinds of encoding. While, at least one of them has to be held constant, there is no reason to alter only one of them. Because of its bandwidth requirements, we would not bother to combine FSK with any other method. But it can be quite fruitful to combine ASK and PSK together and reap the advantages. This technique is called Quadrature Amplitude Modulation (QAM).

We have already seen how ASK is vulnerable to noise. That is why the number of different amplitude levels is small while there may be more phase shift levels possible. There are a large number of schemes possible in the QAM method. For example 1 amplitude and 4 phases is called 4-QAM. It is the same as 4-PSK because there is no change in the amplitude. With 2 amplitudes and 4 phases we can send 3 bits at a time and so this scheme is called 8-QAM (Figure 1.44).

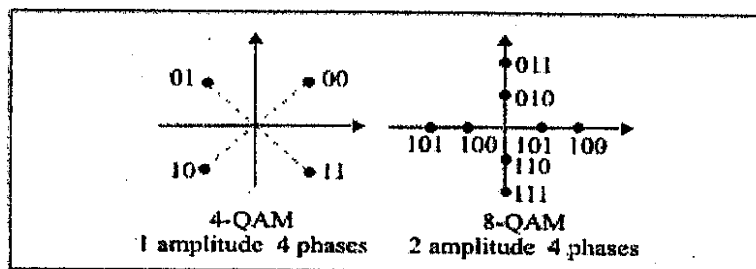

Figure 1.44: 8-QAM and 8-QAM constellations



In practical application we use 3 amplitudes and 12 phases or 4 amplitudes and 8 phases. Although, this way, we should be able to send 4 bits at a time (this is 32-QAM), to guard against errors, adjacent combinations are left unused. So, there is a smaller possibility of noise affecting the amplitude and causing problems with the signal received. As a further safeguard, in some schemes, certain amplitudes and phases are coupled, so that, some amount of error correction is possible at the physical layer itself.

Note, that the errors we have talked of here are at the physical layer. By using the appropriate techniques, at the data link layer we achieve error free transmission irrespective of the underlying mechanisms at the physical layer. That is not something that will be looked at in this unit.

It can be shown that QAM requires the same bandwidth as ASK or PSK. So, we are able to achieve a much higher bit rate using the same baud rate. That is why QAM is the method of encoding used currently in data communication applications.

### 3.5 Digital to Digital Encoding

Let us, now look at the last combination of encoding possible, from digital to digital signals. A simple example is when sending data from a computer to a printer, both of which understand digital signals. The transmission has to be for short distances over the printer cable and occurs as a series of digital pulses. Another example of such encoding is for transmission over local area networks such as an Ethernet, where the communication is between computer and computer.

This kind of encoding is really of three types and we will look at each of the types here. Again, there can be many other mechanisms other than the ones discussed in this unit, but we will look at only the methods that are used in data communication applications. These types are unipolar, polar and bipolar techniques.

#### Unipolar Encoding

This is a simple mechanism but is rarely used in practice because of the inherent problems of the method. As the name implies, there is only one polarity used in the transmission of the pulses. A positive pulse may be taken as a 1 and a zero voltage can be taken as 0, or the other way round depending on the convention we are using (Figure 1.45). Unipolar encoding uses less energy and also has a low cost.

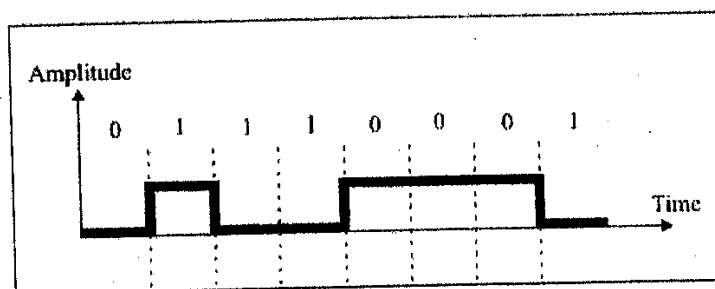

Figure 1.45: Unipolar encoding

What then are the problems that preclude widespread use of this technique? The two problems are those of synchronisation and of the direct current (DC) component in the signal.

In any digital communication system, the transmitter and receiver have to be synchronised or all information may be lost. For example, in determining when to consider the next bit to have started, a very useful mechanism is of using signal transition to indicate start of the next bit. But, if there is a string of bits of the same value, then this method does not work.

In such a case, we have to rely on the clock of the receiver to determine when a bit has ended. This has potential problems because sometimes there can be delays at the transmission end which may stretch the time of transmission, causing the receiver to wrongly believe that there are more bits than is actually the case. Moreover, drift in the clock of the receiver can also lead to difficulties. So, we cannot directly rely on the transmitter and receiver clocks being accurate enough to achieve synchronisation. One way out of this is, to send a separate timing pulse along with the signal on a separate cable, but this increases the cost of the scheme.

Another problem with unipolar encoding is that the average voltage of the signal is non-zero. This causes a direct current component to exist in the signal. This cannot be transmitted through some components of the circuit, causing difficulties in reception.

## **Polar**

Unlike unipolar schemes, the polar methods use both a positive as well as a negative voltage level to represent the bits. So, a positive voltage may represent a 1 and a negative voltage may represent a 0, or the other way round. Because both positive and negative voltages are present, the average voltage is much lower than in the unipolar case, mitigating the problem of the DC component in the signal. Here, we will look at three popular polar encoding schemes.

Non-return to Zero (NRZ) is a polar encoding scheme which uses a positive as well as a negative voltage to represent the bits. A zero voltage will indicate the absence of any communication at the time. Here again there are two variants based on level and inversion. In NRZ- L (for level) encoding, it is the levels themselves that indicate the bits, for example, a positive voltage for a 1 and a negative voltage for a 0 **as shown in Figure 1.45**. On the other hand, in NRZ-I (inversion) encoding, an inversion of the current level indicates a 1, while a continuation of the level indicates a 0 (**Figure 1.46**).

Regarding synchronization, NRZ-L is not well placed to handle it if, there is a string of 0's or 1's in the transmission. But NRZ-I is better off here as a 1 is signalled by the inversion of the voltage. So, every time a 1 occurs, the voltage is inverted and we know the exact start of the bit, allowing the clock to be synchronized with the transmitter. However, this advantage does not extend to the case where there is a string of 1's. We are still vulnerable to losing synchronization in such a case.

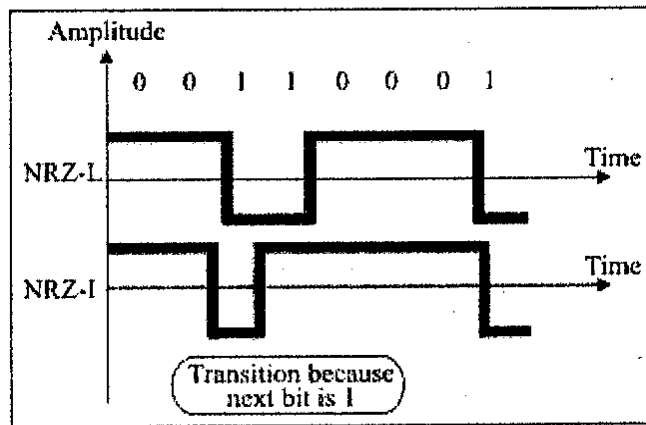

Figure 1.46: NRZ -L and NRZ-I encoding

Return to Zero (RZ) is a method that allows for synchronization after each bit as shown in Figure 1.47. This is achieved by going to the zero-level midway through each bit. So, a 1 bit could be represented by the positive to zero transition and a 0 bit by a negative to zero transition. At each transition to zero, the clocks of the transmitter and receiver can be synchronized. Of course, the price one has to pay for this is a higher bandwidth requirement.

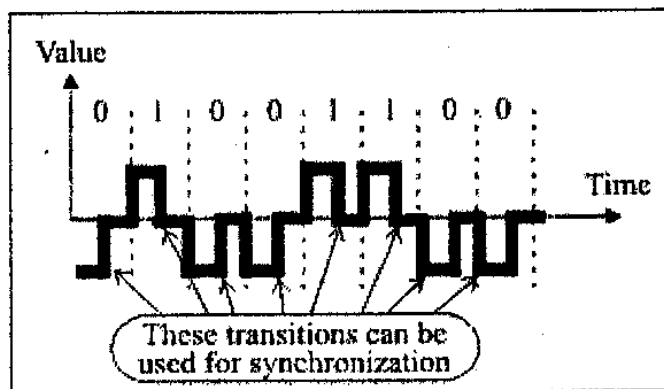

Figure 1.47: RZ encoding

A third polar method is biphase encoding. While in RZ, the signal goes to zero midway through each bit, in biphase it goes to the opposite polarity midway through each bit. These transitions help in synchronization, as you may have guessed. Again, this has two flavours called Manchester encoding and Differential Manchester encoding. The illustration is in Figure 1.40. In the former, there is a transition at the middle of each bit that achieves synchronization. A 0 is represented by a negative to positive transition while a 1 is represented by the opposite. In the Differential Manchester method, the transition halfway through the bit is used for synchronization as usual, but a further transition at the beginning of the bit represents the bit itself. There is no transition for a 1 and there is a transition for a 0, so that a 0 is actually represented by two transitions.

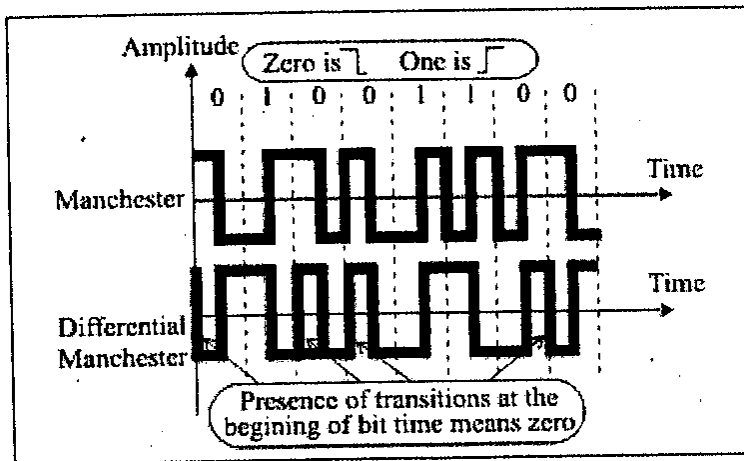

Figure 1.48: Manchester and differential Manchester encoding

### Bipolar

This encoding method uses three levels, with a zero-voltage representing a 0 and a 1 being represented by positive and negative voltages respectively as shown in Figure 1.49. This way the DC component is done away with because, every 1 cancel the DC component introduced by the previous 1. This kind of transmission also ensures that every 1 bit is synchronized. This simplest bipolar method is called Alternate Mark Inversion (AMI). The problem with Bipolar AMI is that synchronization can be lost in a long string of 0's.

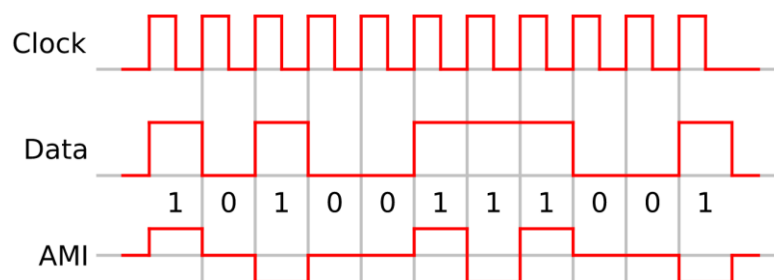

Figure 1.49: Bipola Encoding

One way of synchronizing 0's is to use the High Density Bipolar 3 (HDB3) method. This changes the pattern after every four consecutive 0's. The change is to represent the 0 by a positive or negative signal instead of the zero voltage. How do we prevent this from being wrongly interpreted as a 1? It is done, by using the same voltage level as was used for the previous 1. As in bipolar encoding, a real 1 bit is represented by the opposite voltage level every time, there is no possibility of confusing the 0 with a 1. So we deliberately violate the convention to achieve synchronization, a scheme which works because, the violation can be logically detected and interpreted for synchronization.

HDB3 changes the pattern of four 0's depending on the number of 1's since the last such substitution and the polarity of the last 1. If the number of 1's since the last substitution is odd, the pattern is violated at the fourth 0. So, if the previous 1 was positive, the 0 is also made positive to avoid confusion with a 1. If the number of 1's since the last substitution is even, the first and fourth zeroes have a pattern violation.

Another method of achieving 0 synchronization is called 8-Zero Substitution (B8ZS). Here, a string of 8 zeroes is encoded depending on the polarity of the previous actual 1 bit that occurred. If the previous 1 was sent as a negative voltage, the zeroes are sent as three 0's followed by a negative, positive, zero, positive, negative voltage sequence. A similar but opposite pattern violation is performed for the case where the last 1 was positive. This way a deliberate pattern violation is used to achieve synchronization.



#### 4.0 CONCLUSION

In this unit, you have learnt about data encoding and communication techniques. I believe by now you should be able to discuss intelligently about encoding, what it means, why it is **read** and the various types of encoding mechanisms and techniques.



#### 5.0 SUMMARY

In this unit, you have seen the need for data encoding and seen that there are four types of data encoding. These arise from the fact that there are 2 source signal types and 2 transmission types. You have seen the different kind of techniques used for each type of data encoding -analogue- to-analogue, analogue to digital, digital to analogue and digital-to-digital. The bandwidth needed, noise tolerance, synchronization methods and other features of each different technique of encoding have been elaborated upon.



#### 6.0 TUTOR MARKED ASSIGNMENT 3

1. List three techniques of digital-to-digital conversion.
2. Distinguish between data rate and signal rate.
3. Define a DC component and its effect on digital transmission.
4. List five lines coding schemes discussed in this book.
5. Define scrambling and give its purpose.
6. What are the differences between parallel and serial transmission?
7. Calculate the value of the signal rate for each case in the figure below if the data rate is 1 Mbps and  $c = 1/2$ .
8. Draw the graph of the NRZ-L scheme using each of the following data streams, assuming that the last signal level has been positive. From the graphs, guess the bandwidth for this scheme using the average number of changes in the signal level. Compare your guess with the corresponding entry in the table below
  - i. 00000000
  - ii. 11111111
  - iii. 01010101
  - iv. 00110011

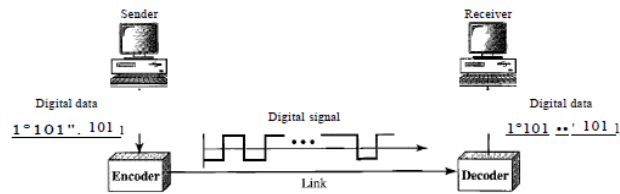

9. What is the Nyquist sampling rate for each of the following signals?
  - a. A low-pass signal with bandwidth of 200 KHz?
  - b. A band-pass signal with bandwidth of 200 KHz if the lowest frequency is 100 KHz?
  
10. What is the maximum data rate of a channel with a bandwidth of 200 KHz if we use four levels of digital signalling?
  
11. We have a baseband channel with a 1-MHz bandwidth. What is the data rate for this channel if we use one of the following line coding schemes?
  - a. NRZ-L
  - b. Manchester
  - c. MLT-3
  - d. 2B1Q



## 7.0 REFERENCES/FURTHER READINGS

Michael A Gallo and William M Hancock (2004). *Computer Communications and Networking Technologies*, Thomson Asia; Second Reprint.

Behrouz Forouzan (2016). *Introduction to Data Communications and Networking*, Tata McGraw-Hill.

Tirothy S. Ramteke (2004). *Networks*, Second Edition, Pearson Education: New Delhi.

## 8.0 ANSWERS TO SELF-ASSESSMENT 6

### Question 1

Why do we need modulation? Would it be right to simply send the information as the signal itself?

### Solution

Modulation is the technique of changing one or more attributes of periodic wave known as carrier signal with the adjusting signal that naturally consists of information to be sent.

Why do we need modulation?

We need modulation because

- a. Data signal wave is a low frequency signal wave. Example of such data signal wave are conversation and music  
Modulation enables data signal wave to become a higher signal wave since lower frequency wave is more adaptable to blockage than higher frequency wave.
- b. Higher frequency wave carries more data since it has more bandwidth.
- c. Much larger-size antenna is required at the destination by lower frequency signals. However, the size of the antenna will be reduced with the increase of the wave frequency by modulation.
- d. It is pertinent to note that data signal is hidden inside carrier wave through modulation, thereby, providing security.

Would it be right to simply send the information as the signal itself?

No, it will not be correct simply send the information as the signal itself because of the many advantages of modulation. Students can explore more on this.

## **Question 2**

A common fm broadband has a derivation of  $\pm 75\text{kHz}$  bandwidth and a modulation frequency of  $15\text{kHz}$ . Calculate the bandwidth of 98% of the power.

### **Solution**

This calculation shall be done using Carlson's rule which states that 98% of the power is contained within a bandwidth equal to the deviation frequency, plus the modulation frequency doubled. The formula states

that

$$BT = 2 (\Delta f + f_m)$$

Where

$\Delta f$  = deviation

$BT$  = total bandwidth (for 98% power)

$f_m$  = frequency modulation

In this case, the common fm signal has a deviation of  $\pm 75\text{kHz}$  and  $15\text{kHz}$ . Thus, the bandwidth of 98% of the power approximate to

$$2(75+15) = 180\text{kHz}$$

It is pertinent to note that 200kHz is allowed for each station give room for acceptance spaced channels.

### Question 2

Why is AM the most susceptible to noise of the three types of modulation?

### Solution

AM is the most susceptible to noise since noise is in the channel (i.e. atmosphere) which easily creep into the signal and alter its amplitude.

## 9.0 ANSWERS TO TUTOR MARKED ASSIGNMENT 3

### Question 1

List three techniques of digital-to-digital conversion.

### Solution

The three different techniques described in this chapter are *line coding*, *block coding*, and *scrambling*.

### Question 2

Distinguish between data rate and signal rate.

### Solution

The *data rate* defines the number of data elements (bits) sent in 1s. The unit is bits per second (bps). The *signal rate* is the number of signal elements sent in 1s. The unit is the baud.

### Question 3

Define a DC component and its effect on digital transmission

Solution

When the voltage level in a digital signal is constant for a while, the spectrum creates very low frequencies, called *DC components*, that present problems for a system that cannot pass low frequencies.

### Question 4

List five lines coding schemes discussed in this section.

### Solution



In this section, we introduced *unipolar*, *polar*, *bipolar*, *multilevel*, and *multitransitional* coding.

**Question 5**

Define scrambling and give its purpose.

**Solution**

*Scrambling*, as discussed in this section, is a technique that substitutes long zero level pulses with a combination of other levels without increasing the number of bits.

**Question 6**

What are the differences between parallel and serial transmission?

**Solution**

In *parallel transmission* we send data *several* bits at a time. In *serial transmission* we send data *one* bit at a time.

**Question 7**

Calculate the value of the signal rate for each case in the figure below if the data rate is 1 Mbps and  $c = 1/2$ .

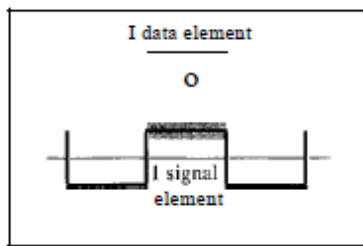

a. One data element per one signal element ( $r = 1$ )

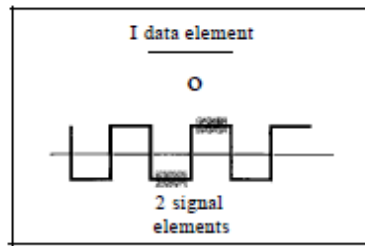

b. One data element per two signal elements ( $r = \frac{1}{2}$ )

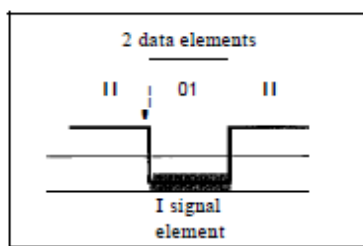

c. Two data elements per one signal element ( $r = 2$ )

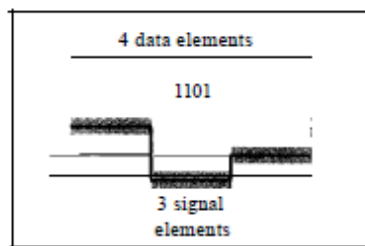

d. Four data elements per three signal elements ( $r = \frac{4}{3}$ )

**Solution**

We use the formula  $s = c \times N \times (1/r)$  for each case. We let  $c = 1/2$ .

a.  $r = 1 \rightarrow s = (1/2) \times (1 \text{ Mbps}) \times 1/1 = 500 \text{ kbaud}$

b.  $r = 1/2 \rightarrow s = (1/2) \times (1 \text{ Mbps}) \times 1/(1/2) = 1 \text{ Mbaud}$

c.  $r = 2 \rightarrow s = (1/2) \times (1 \text{ Mbps}) \times 1/2 = 250 \text{ Kbaud}$

d.  $r = 4/3 \rightarrow s = (1/2) \times (1 \text{ Mbps}) \times 1/(4/3) = 375 \text{ Kbaud}$

**Question 8**

Draw the graph of the NRZ-L scheme using each of the following data streams, assuming that the last signal level has been positive. From the graphs, guess the bandwidth for this scheme using the average number of changes in the signal level.

Compare your guess with the corresponding entry in the table below

- c. 00000000
- d. 11111111
- e. 01010101
- f. 00110011

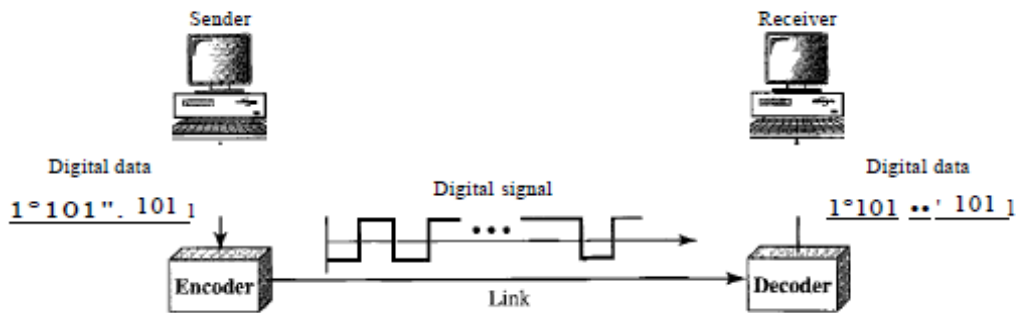

**Solution**

Average Number of Changes =  $(0 + 0 + 8 + 4) / 4 = 3$  for  $N = 8$   
 $B \rightarrow (3/8) N$

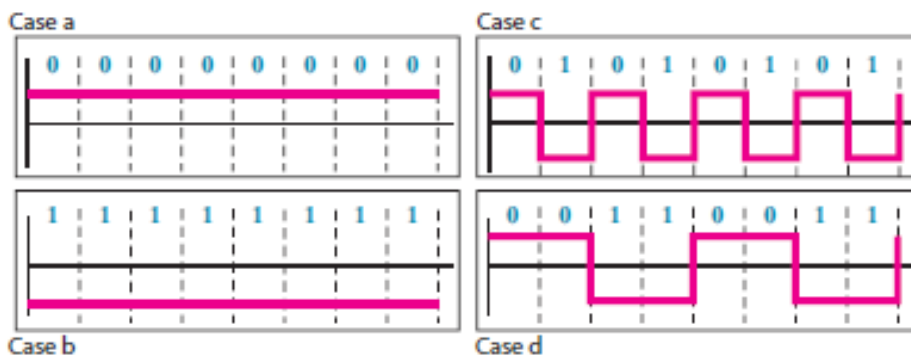

**Question 9**

9. What is the Nyquist sampling rate for each of the following signals?

- a. A low-pass signal with bandwidth of 200 KHz?

- b. A band-pass signal with bandwidth of 200 KHz if the lowest frequency is 100 KHz?

**Solution**

- a. In a low-pass signal, the minimum frequency 0.

Therefore,

we have  $f_{\max} = 0 + 200 = 200$  KHz.  $\rightarrow f_s = 2 \times 200,000 = 400,000$  samples/s

- b. In a bandpass signal, the maximum frequency is equal to the minimum frequency plus the bandwidth. Therefore,

we have  $f_{\max} = 100 + 200 = 300$  KHz.  $\rightarrow f_s = 2 \times 300,000 = 600,000$  samples /s

**Question 10**

What is the maximum data rate of a channel with a bandwidth of 200 KHz if we use four levels of digital signalling

**Solution**

The maximum data rate can be calculated as  $N_{\max} = 2 \times B \times n_b = 2 \times 200$  KHz  $\times \log_2 4 = 800$  kbps

**Question 11**

We have a baseband channel with a 1-MHz bandwidth. What is the data rate for this channel if we use one of the following line coding schemes?

- a. NRZ-L
- b. Manchester
- c. MLT-3
- d. 2B1Q

**Solution**

We can calculate the data rate for each scheme:

- a. NRZ  $\rightarrow N = 2 \times B = 2 \times 1$  MHz = 2 Mbps
- b. Manchester  $\rightarrow N = 1 \times B = 1 \times 1$  MHz = 1 Mbps
- c. MLT-3  $\rightarrow N = 3 \times B = 3 \times 1$  MHz = 3 Mbps
- d. 2B1Q  $\rightarrow N = 4 \times B = 4 \times 1$  MHz = 4 Mbps

**Question 12**

Why is PAM necessary pre-requisite to PCM? Why can we not use PCM directly?

**Solution**

PAM is necessary prerequisite for PCM because it converts analogue signal into a series of Pulses, then digitize the signal into what is called quantization. Hence, the resulting binary digits is then transformed to digital signal using any of the digital to digital encoding mechanization. This digital signal is the representation of the original analogue signal.

Why can we not use PCM directly?

**Solution**

PCM cannot be used directly because the data in discuss are analogue data which needs to be converted to digital before it can be used by PCM.

## UNIT 4 MULTIPLEXING AND SWITCHING

### CONTENTS

- 1.0 Introduction
- 2.0 Objectives
- 3.0 Main Content
  - 3.1 Multiplexing
    - 3.1.1 Frequency Division Multiplexing
    - 3.1.2 Time Division Multiplexing
  - 3.2 Digital Subscriber Lines
  - 3.3 ADSL vs. Cable
  - 3.4 Switching
    - 3.4.1 Circuit Switching
    - 3.4.2 Packet Switching
- 4.0 Conclusion
- 5.0 Summary
- 6.0 Tutor-Marked Assignment
- 7.0 References/Further Readings



### 1.0 INTRODUCTION

The transmission of data over a network, whether wireless or not, requires us to solve the problem of being able to send a large amount of data among different groups of recipients at the same time without the message of one being mixed up with those of the others. For example, think of the thousands of radio or television channels that are being broadcast throughout the world simultaneously, or of the millions of telephone conversations that are taking place every minute of the day. This feat is achieved by multiplexing the transmissions in some way. In this unit, we will look at the different methods of multiplexing that are commonly used, frequency division multiplexing and time division multiplexing. Time division multiplexing again can be synchronous or statistical.

There are some differences in the characteristics of voice and data communication. Although, finally everything is really data, these differences dictate the design of the telephone network as well as the techniques of switching. When one wants to transmit data over a telephone line, we have to make some changes to be able to get sufficiently high speeds. We will look at ADSL, a scheme for doing this at rates that can compete on cost and quality with those offered by cable television service providers. We will also look at the advantages and disadvantages of the two methods and of high-speed data access.

When constructing networks of any size, a fundamental requirement is that any two nodes of the network should be able to communicate with each other, for, if they cannot do so, they are not on the same network. This brings up the issue of how to switch the data stream, that is, to make sure it reaches its destination and not some

other random location on the network. This unit will, describe the different switching techniques available to make this possible.



## 2.0 OBJECTIVES

After going through this unit, you should be able to:

1. state what multiplexing and switching mean
2. state how a telephone line can be used for transmitting data using ADSL
3. describe the differences between ADSL and cable television for data access;
4. describe the different kinds of multiplexing and switching
5. state the characteristics of Frequency Division Multiplexing
6. describe the features of Time Division Multiplexing, both synchronous and statistical
7. differentiate between the different kinds of switching.



## 3.0 MAIN CONTENT

### 3.1 Multiplexing

If, one wanted to send data between a single source and a single destination, things would be comparatively easy. All it would need is a single channel between the two nodes, of a capacity sufficient to handle the rate of transmission based on Nyquist's theorem and other practical considerations. Granted that there would be no other claimants for the resources, there would be no need for sharing and no contention.

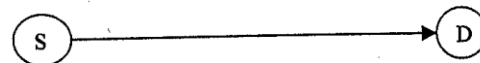

The transmission channel would be available to the sole users in the world at all times, and any frequency which they chose could be theirs. In a broadcasting case, we could have the single source transmitting at any time of its choosing and at any agreed upon frequency.

However, things are not so straightforward in the real world. We have a large number of nodes, each of which may be transmitting or receiving, from or to possibly different nodes each time. These transmissions could be happening at the same moment. So, when we need to transmit data on a large scale, we run into the problem of how to do this simultaneously, because, there can be many different sources and the intended recipients for each source are often different. The transmission resource, that is the available frequencies, is scarce compared to the large number of users. So, there will have to share the resource and consequently, the issue of preventing interference between them will arise.

If, all possible pairs of nodes could be completely connected by channels(?!), we would still not have a problem. But that is obviously out of the question, given the very large number of possible source and destination nodes. There would be over a billion telephones in the world today, for instance.

This problem is solved by performing what is called multiplexing. It can be done by sharing the available frequency band or by dividing up the time between the different transmissions. The former is called Frequency Division Multiplexing (FDM) while the other scheme is Time Division Multiplexing (TDM).

Another reason for multiplexing is that it is more economical to transmit data at a higher rate as the relative cost of the equipment is lower. But at the same time, most applications do not require the high data rates that are technologically possible. This is an added inducement to multiplex the data so that, the effective cost can be brought down further by sharing across many different, independent transmissions.

In this context, a multiplexer is a device that can accept  $n$  different inputs and send out 1 single output. This output can be transmitted over a link or medium to its destination, where to be useful, the original inputs have to be recovered. This is done by a demultiplexer. We need to realize that for this kind of scheme to work, the creation of the composite signal by the multiplexer needs to be such that, the original component signals can be separated at the receiving end -otherwise we would end up with just a lot of noise!

When we transmit data over a cable, we are really setting up a different medium. We can transmit data over different cables at the same frequency at the same time without interference because the media or links are different even in radio transmission, where the medium is space and hence is a single medium available to all transmissions, geographical distance can in many cases give rise to different links. A low power medium wave transmission happening in India can be done simultaneously with a similar transmission in Europe without interference or the need for any special precautions. However, throughout the rest of the unit, when we talk of multiplexing, we are referring to the simultaneous transmission of data over the same medium or link.

### 3.1.1 Frequency Division Multiplexing

Suppose, it is human voice that has to be transmitted, over a telephone. This has frequencies that are mostly within the range of 300 Hz to 3400Hz. We can modulate this on a bearer or carrier channel, such as one at 300 kHz. Another transmission that has to be made can be modulated to a different frequency, such as, 304 kHz, and yet another transmission could be made simultaneously at 308 kHz. We are thus, dividing up the channel from 300 kHz up to 312 kHz into different frequencies for sending data. This is Frequency Division Multiplexing (FDM) because all the different transmissions are happening at the same time -it is only the frequencies that are divided up.

The composite signal to be transmitted over the medium of our choice is obtained by summing up the different signals to be multiplexed (Figure 1.50). The transmission is received at the other end, the destination and there, it has to be separated into its original components, by demultiplexing. In practice, a scheme like this could result in interference or cross talk between adjacent channels because the bandpass filters that are used to constrain the original data between the agreed upon frequencies (300 to 3400 kHz) are not sharp. To minimize this, there are guard bands, or unused portions of the spectrum between every two channels.

Another possible cause of interference could arise because of the fact that the equipment, such as amplifiers used to increase the strength of the signal, may not behave linearly over the entire set of frequencies that we seek to transmit. Then, the output can contain frequencies that are the sum or difference of the frequencies used by the input. This produces what is called intermodulation noise.

In this kind of division, it should be realised that the actual modulation technique used is not of consequence. So, one could use analogue modulation (AM) or Frequency Modulation (FM). Also the composite signal that we have produced could again be modulated over a different frequency altogether. For example, the three voice channels, that have been modulated for commercial broadcast radio to produce a spectrum from 300 kHz to 312 kHz could be modulated onto a 2 GHz satellite channel for long distance transmission to the other side of the earth. This second modulation could use a technique different from the first one. The only thing that needs to be taken care of is, that the recovery of the original signals have to be done in the reverse order, complementing the method used for producing the composite signal.

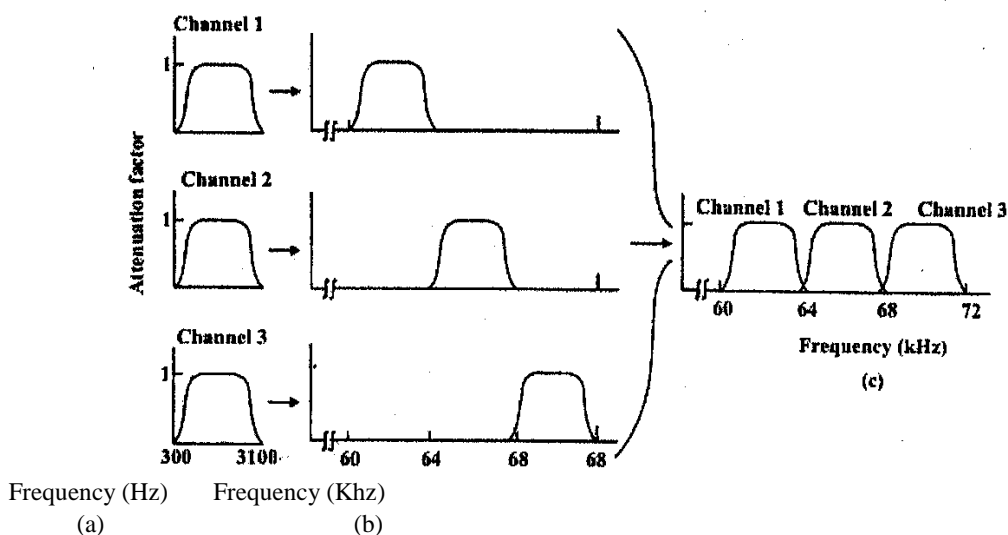

Figure 1.50: Frequency division multiplexing

[Source: Computer Network by A.S Tanenbaum]

The International Telecommunication Union (ITU) has standardised a hierarchy of schemes that utilise FDM for the transmission of voice and video signals as shown in Figure 1.43. To begin with, a cluster of 12 voice channels, each of 4 kHz is combined to produce a signal of bandwidth 48 kHz that is then, modulated and transmitted over the 60 to 108 kHz band. This is called a group.

The next level of the hierarchy is the supergroup, where 5 such groups are combined to use 240 kHz of bandwidth, occupying from 312 to 552 kHz. The next level is the master group that consists of 5 such supergroups. This uses 1232 kHz from 812 to 2044 kHz. Again, 3 such super groups form a super master group that contains 3.872 MHz from 8.516 to 12.388 MHz. The United States uses a similar hierarchy as decided by AT&T (the telecommunications company) that is, not entirely identical to the ITU standard.



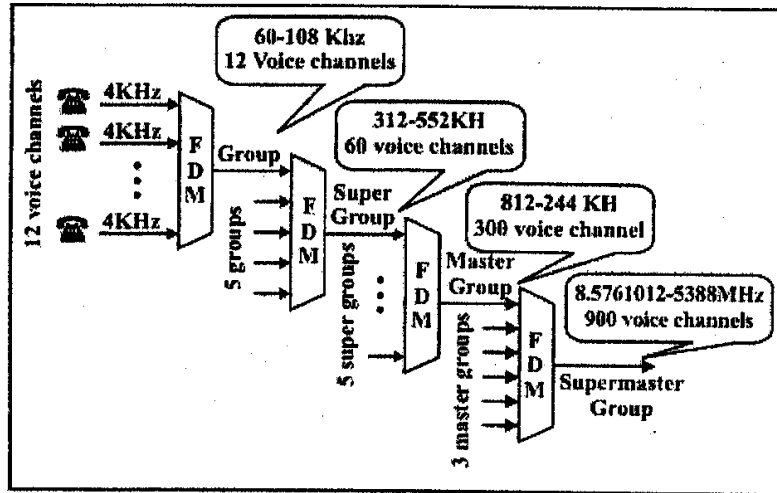

Figure 1.51: Analogue hierarchy

We, thus, see that the original signal could find itself subjected to modulation several times, each of which may be of different kinds, before it is finally transmitted. This raises the possibility of interference and noise, but, with the very good equipment available today, this need not be a matter of concern.

FDM has the disadvantage of not being entirely efficient if the transmissions that are multiplexed together have periods of silence or no data. Since, a frequency band is dedicated to each data source, any such periods are simply not **utilised**.

### 3.1.2 Time Division Multiplexing

Another multiplexing scheme is to use the entire bandwidth for each channel but to divide it into different time slots, as shown in **Figure 1.52**.

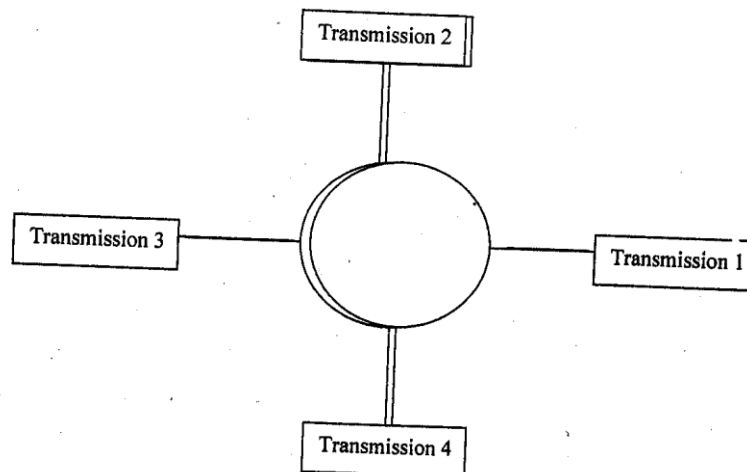

Figure 1.52: Time division multiplexing

In this case, we have four different transmissions occurring with each being  $\frac{1}{4}$  of the time slice. The slice should be small enough so that the slicing is not apparent to the application. So, for a voice transmission, a cycle of 100ms could be sufficient as we

would not be able to detect the fact that there are delays. In that case, each transmission could be allotted a slice of 25ms.

At the receiving end, the transmission has to be reconstructed by dividing up the cycle into the different slices, taking into account the transmission delays. This synchronisation is essential, for if the transmission delay is, say 40ms, then the first transmission would start reaching 40ms later, and would extend to 65ms. If, we interpreted it to be from 0 to 25ms, there would be complete loss of the original transmission. This interleaving of the signal could be at any level starting from that of a bit or a byte or bigger.

### **Synchronous Time Division Multiplexing**

In this kind of Time Division Multiplexing (TDM), the simpler situation is where the time slots are reserved for each transmission, irrespective of whether it has any data to transmit or not. Therefore, this method can be inefficient because many time slots may have only silence. But it is a simpler method to implement because the act of multiplexing and demultiplexing is easier. This kind of TDM is known as Synchronous TDM.

Here, we usually transmit digital signals, although the actual transmission may be digital or analogue. In the latter case, the composite signal has to be converted into analogue data by passing it through a modem. Here, the data rate that the link can support has to at least equal the sum of the data rates required for each transmission. So, if one has to transmit four streams of data at 2400 bps each, we would need a link that can support at least 9600 bps. For each data stream, we would typically have a small, say 1 character buffer, that would take care of any data flow issues from the source.

Although, the transmission has to be synchronous, that is not the reason the scheme is called Synchronous TDM. It is because of the fact that each data source is given fixed slots or time slices. We can also support data sources with differing data rates. This could be done by assigning fewer slots to slower sources and more slots to the faster ones. Here, a complete cycle of time slots is called a frame. At the receiving end, the frame is decomposed into the constituent data streams by sending the data in each time slot to the appropriate buffer. The sequence of time slots allotted to a single data source makes up a transmission channel.

We have already seen that the transmission in TDM must be synchronous because otherwise, all the data would be garbled and lost. How is this achieved? Because this unit is concerned with the physical layer and not the data link layer, we will not concern ourselves with the problem of flow control or error correction or control. But even at the physical layer, we have to ensure that each frame is synchronised to maintain the integrity of the transmission.

One scheme to attain this is to add an extra bit of data to each frame. In succeeding frames, this extra bit forms a fixed pattern that is highly unlikely to occur naturally in the data. The receiver can then use this fact to synchronise the frames. Suppose each frame has  $n$  bits. Starting from anywhere, the receiver compares bit number 1,  $n+1$ ,  $2n+1$  and so on. If the fixed data pattern is found, the frames are synchronised. Otherwise, the receiver commences to check bit number 2,  $n+2$ ,  $2n+2$ , ...until it can

determine whether the frames are in synchronization or otherwise. This continues till, it is able to synchronise the frames and can then start receiving the data from the various channels.

Even after this, it is important to continue to monitor the fixed pattern to make sure that the synchronisation remains intact. If it is lost, the routine of re-establishing it needs to be repeated as before.

The second problem in synchronising the transmission is the fact that there can be some variations between the different clock pulses from the different input streams. To take care of this, we can use the technique of pulse stuffing. Here, the multiplexed signal is of a rate that is a bit higher than that of the sum of the individual inputs. The input data is stuffed with extra pulses as appropriate by the multiplexer at fixed locations in the frame. This is needed so that the demultiplexer at the other, receiving, end can identify and remove these extra pulses. All the input data streams are thus synchronised with the single local, multiplexer clock.

### **Statistical Time Division Multiplexing**

We have seen that synchronous TDM can be quite wasteful. For example, in a voice transmission, much of the bandwidth can be wasted because there are typically many periods of silence in a human conversation. Another example, could be, that of a timesharing system where many terminals are connected to a computer through the network. Here too, many of the time slots will not be used because there is no activity at the terminal. In spite of being comparatively simpler, synchronous TDM is therefore, often not an attractive option.

To take care of this problem, we can use statistical TDM. This is a method where there are more devices than the number of time slots available. Each input data stream has a buffer associated with it. The multiplexer looks at the buffer of each device that provides the input data and checks to see if it has enough to fill a frame. If, there are enough, the multiplexer sends the frame. Otherwise, it goes to the next device in line and checks its input buffer. This cycle is continued indefinitely. At the receiving end the demultiplexer decomposes the signal into the different data streams and sends them to the corresponding output line.

The multiplexer data rate is not higher than that of the sum of all the input devices connected to it. So statistical, TDM can make do with a lower transmission rate than needed by synchronous TDM, at the cost of more complexity. The other way in which this is of benefit is, by the ability to support higher throughput for the same available data rate of the multiplexer. This capability is easily realised during the normal, expected data transmission periods when the amount of data that the different input devices have available for transmission is, in fact, lower than the capacity of the multiplexing device. But the same attribute becomes a disadvantage during peak loads, where all or many of the devices may have data to transmit for a short time. In such a situation, the slack that was available to us for more efficient transmission is no longer present. We will see later how to handle peak load situations in statistical **TDM**.

In this kind of scheme, it is not known to us which input device will have data to send at a given time. So, we cannot use a round robin positional scheme that was

possible in synchronous **TDM**. Each frame has to be accompanied by information that will tell the demultiplexer which input device the frame belongs to, so that it can be delivered to the appropriate destination. This is the overhead of statistical TDM, besides increased complexity of equipment.

If, we are sending input data from only one source at a time, the structure of a frame would need to have an address field for the source followed by the data for it. This is really the statistical TDM data frame. It would form the data part of a larger, enclosing **High Level Data Link Control (HDLC)** frame if we are using **HDLC** as the transmission protocol. This frame would itself have various other fields that we will not discuss here.

Such a scheme is also not as efficient as we can make it. This is because the quantum of data available from the source, in that time slot, may not be enough to fill the TDM sub frame. So, while it may be an adequate method if the load is not heavy, we also need to think of a method that can utilise available resources better.

The way to do this would be, to have more than one input data source transmit in a single TDM frame. We would then need to have a more complex structure for the frame whereby, we would have to specify the different input devices in the frame followed by the length of the data field. More sophisticated approaches could be used, in order to optimise the number of bits, we need to encode all this addressing and data information.

For peak loads, there is need for some kind of buffering mechanism, so that, whenever there is excess input from the data sources that the multiplexer cannot immediately handle, it is stored until it can be sent. The size of the buffer needed will increase as the transmission capacity of the multiplexer decreases, as it will become more likely that an input data stream will not be transmitted immediately. It will also depend on the average data rate of the input devices taken together. No matter what the buffer size we choose, there is always a non-**zero** probability that the buffer itself will overflow, leading to loss of data. If, the average data rate of all devices is close to the peak rate, then we are approaching a situation of synchronous TDM where we are not able to take advantage of periods of silence that is the basis of statistical TDM.

### **3.2 Digital Subscriber Lines**

Digital Subscriber Lines are an example of multiplexing in action. They are really telephone lines that can support much higher data rates than are possible with an ordinary telephone connection. The concept came up in response to the high data rates of more than 10 Mbps offered by cable television providers. Compared to those rates, the 56Kbps possible over a telephone dial up connection was a miserable offering.

The 56 Kbps rate is really an artificial barrier arising from the fact that voice telephone line standards limited the bandwidth to about 3.1 KHz to take advantage of the normal range of the human voice in conversation. Nyquist's theorem and the limitations of line quality ensured that we ended up with that rate. Once the 3.1 KHz limit is removed, the telephone line can support much higher data speeds.

Out of the several different technical solutions that came about, the ADSL (Asymmetric DSL) technology has proved to be the most popular. Asymmetric comes from the fact that the data rates in the two directions are different. The approach is to divide the 1.1 MHz bandwidth available over the Cat-3 telephone cables into 256 channels. Of these channels, 0 is used for normal voice communication. The next 5 channels are not used to ensure separation and non-interference between data and voice transmissions. The next 2 channels are used for upstream and downstream control. The remaining 248 channels are available for data transmission.

Like in voice circuits, it would have been possible to use half the channels for communication in each direction. But, statistics show that most users download much more data than they upload. So usually 32 channels are dedicated to uploading, that is, transferring data from the users to the provider and the remaining 216 channels are used for downloading data to the users. This typically translates into 512 Kbps to 1 Mbps download and 64 Kbps to 256 Kbps upload data rates. This then, is the asymmetric aspect of the DSL line.

A problem with ADSL is that the physics of the local loop is such that, the speed at which it can be driven depends heavily on the distance between the subscriber's premises and the provider's nearest termination point. The speed falls sharply with distance and so, distance can become a limiting factor in being able to offer competitive speed compared to that of the cable television providers.

However, ADSL is comparatively simple for a service provider to offer, given an existing telephone network, and does not require much change to its already available equipment. It necessitates two modifications, one each, at the subscriber end and at the end office. On the user's premises, a Network Interface Device has to be installed that incorporates a filter. This is called a splitter and it sends the non-voice portion of the signal to an ADSL modem. The signal from the computer has to be sent to the ADSL modem at high speed, usually done these days by connecting them over a USB port.

At the provider's end office, the signal from the users is recovered and converted into packets that are then sent to the Internet Service Provider, which may be the telephone company itself.

### **3.3 ADSL vs. Cable**

At first glance, a comparison between ADSL and cable may seem like a no contest. Cable television, sent over coaxial cables, has a bandwidth that is potentially hundreds of times that of the twisted pair Cat-3 cable used for telephone connections. But, as we go along, it turns out that there are considerations in favour of both sides.

First, there are specific assurances regarding bandwidth that we get from telephone companies who provide ADSL connectivity. An ADSL link is a dedicated connection that is always available to the user, unlike television cable that is shared by scores or even hundreds of subscribers in the immediate neighbourhood. So the

kind of speeds that we can get over cable can vary from one moment to the next, depending on the number of users that are working at the time.

There are security risks associated with the fact that cable is shared. Potentially other users can always tap in and read (even change) what you are sending or receiving. The problem does not exist on ADSL, because, each channel is separate and dedicated to the specific user. Though, cable traffic is usually encrypted by the provider, this situation is worse than ADSL where other users just do not get your traffic at all. Also because the channel is dedicated to you, the total number of users does not have any effect on your access speeds as there is no contention with other users.

### 3.4 Switching

There are many potential sources of data in the world and likewise, many potential recipients. Just think of the number of people who may like to reach one another over the telephone. How can one ensure that every data source is able to connect to the recipient? Clearly one cannot have a physical link between every pair of devices that might want to communicate. Therefore, we need a mechanism, to be able to connect together devices that, need to transfer data between them. This is the problem of switching.

There are two basic approaches to switching. In circuit switching, we create a circuit or link between devices, for the duration of time for which they wish to communicate. This requires a mechanism for, the initiating device to choose the device that it wants to send data to. All devices must also have an identifying, unique address that can be used to set up the circuit. Then, the transmission occurs, and when it is over, the circuit is dismantled so that the same physical resources can be used for another transmission.

The packet switching approach can be used when we are using datagrams or packets to transmit data over the channel. Each datagram is a self-contained unit that includes within itself the needed addressing information. The datagrams can arrive at the destination by any route and may not come in sequence.

#### 3.4.1 Circuit Switching

As **discussed** already, in circuit switching, we create a link or circuit between the devices that need to communicate, for the duration of the transmission only. It entails setting up the circuit, doing the actual transmission that can be simplex, half duplex or full duplex, and then dismantling the circuit for use by another pair of devices. An example is shown in the **Figure 1.53** where there are 7 devices. These are divided into two groups of 3 on the left and 4 on the right. To ensure complete connectivity between them at all times, we would need 12 physical links. But, if connectivity is not required at all times, we can achieve connectivity between any of the devices by grouping them together and using switches to achieve temporary links.

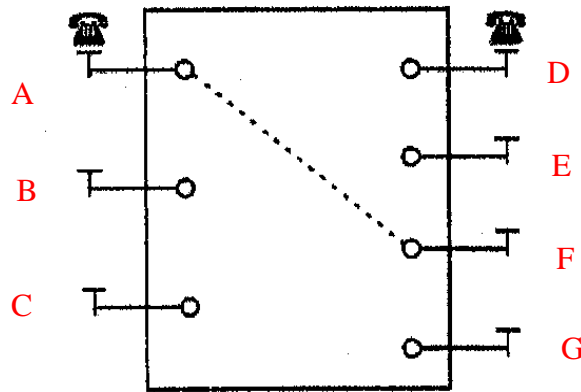

Figure 1.53: Circuit Switching

For example, we can have 7 links that connect the devices A, B and C on the left to the switch. The other devices D, E, F and G on the right are also connected to the same switch. The switch can connect any two devices together using only these seven links as desired.

The capacity of the switch is determined by the number of circuits that it can support at any given time. In the Figure 1.53 example, we have seen a switch with 1 input and 1 output. If devices C and E are communicating with each other, the others cannot communicate at the same time, although, there are available links from them to the switch. A circuit switch is really a device that has  $n$  inputs and  $m$  outputs ( $n$  need not be equal to  $m$ ).

There are two main approaches to circuit switching, called space division or time division switches. Space division switches are so called because the possible circuit paths are separated from one another in space. The old, and now obsolete, crossbar telephone exchanges are an example of space division switching. The technique can be used for both digital or analogue systems. There were other designs of such switching but the only one that went into large scale use was the crossbar. Because of the way it is constructed, such switching does not have any delays. Once the path is established, transmission occurs continuously at the rate that the channel can support.

In essence, a crossbar connects  $p$  inputs to  $q$  outputs. Each such connection is actually performed by connecting the input to the output using some switching technology such as, a transistor based electronic switch or an electromechanical relay. This requires a large number of possible connections, called cross points. For a 10,000line telephone exchange, it would mean that, each of the 10,000 possible inputs be able to connect to any of the 10,000 possible outputs, requiring a total of 100,000,000 cross points. As this is clearly impractical, the pure crossbar design is not usable on a commercial scale. Moreover, there are inherent inefficiencies in this design as statistically, only a small fraction of these cross points are ever in use simultaneously.

The way to get around this limitation is, to split the switch into different stages. If we consider a 36 line exchange where each of 36 inputs needs to be connected to 36 outputs, we can do so in, say, 3 stages. The first stage could have 3 switches, each with 12 inputs and 2 outputs to the two second stage switches. These intermediate



switches could each have 3 inputs from the 3 first stage switches and 3 outputs to the 3 third stage switches. The last stage of the switches would then have 2 inputs from the 2 second stage switches and 12 outputs, each to 12 of the 36 devices. It is thus, possible for each of the 36 inputs to connect to each of the 36 outputs as required, using only  $72 + 18 + 72 = 162$  cross points, instead of the 1296 cross points that would have been required without the multistage design. The following [Figure 1.54](#) shows the multistage switch.

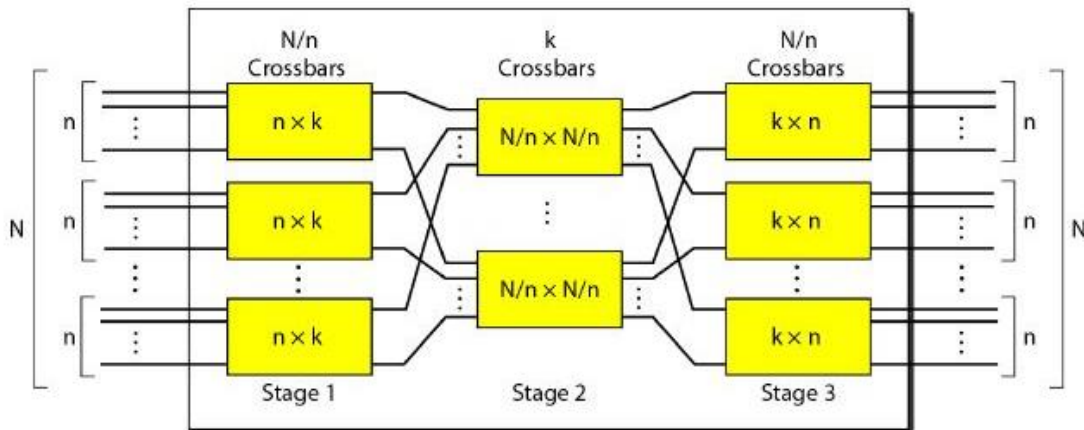

[Figure 1.54: Multistage Switch](#)

If, we use a single stage switch, we will always be able to connect each device to any other device that is not already busy. This is because all the paths are independent and do not overlap. What this means is that, we will never be starved of circuits and will never suffer the problem of blocking. For multistage switching, the reduction in the number of cross points required comes at the cost of possible blocking. This happens when there is no available path from a device, to another free device, that we desire to connect to. In the [Figure 1.54](#), if we have a switch in the first stage that is already serving 2 input devices, then there are no free outputs from that stage. We cannot therefore service more than 2 input devices connected to one switch at a time and the 3M device would not be able to connect anywhere, getting a busy signal.

It is possible to minimise the possibility of blocking by using stochastic analysis to find the least number of independent paths that we should provide for. However, we will not go into such an analysis in this unit. But, we can see that the limiting factor in the [Figure 1.54](#) is the middle stage where there are only 3 inputs and 2 outputs. This is the point at which congestion is most likely to occur. You too may have experienced blocking when trying to make a telephone call and found that you got an exchange busy tone, indicating that it was not the number you called but the exchange (switch) itself that was congested. Such a problem is, most likely to occur during periods of heavy activity such as at midnight on a New Year's Day, when many people might be trying to call one another to exchange greetings.

Another advantage of multistage switching is that, there are many paths that can be used to connect the input and output devices. So, in the above case, if there is a failure in one of the connections in the first stage switch, two input devices can still



connect to it. In the case of single stage switching, that would have meant that we could not set up a circuit between those devices.

Let us, now look at another method of switching that uses time slots rather than spatial separation. You have already seen how synchronous TDM involves transmission between input and output devices using fixed time slots dedicated to each channel. But that is not switching because the input-output device combinations are fixed. So, if we have three devices A, B and C transmitting and three devices D, E and F that are receiving the respective transmissions, there will be no way to change the circuit path so that A can transmit to E or F.

To achieve switching, we use a device called a Time Slot Interchange (TSI). The principle of such a device is simple. Based on the desired paths that we want to set up, the TSI changes the input ordering in the data streams. So, if the demultiplexer is sending the outputs to D, E and F in order, and if we want that A send data to E instead of F, and that B send data to F rather than E, then the TSI will change the input ordering of the time slots from A, B, C to C, A, B. The demultiplexer will not be aware of this and will continue to send the output the same way as before. The result will be, that our desired switching will be accomplished. However, unlike space division switching, our output will be subject to delays because we might have to wait for the input from the right device before it can be transmitted. This is unlike space division switching where the data can be sent in a steady stream.

How does the TSI work? It consists of a control unit that does the actual reordering of the input. For this, it has to first, buffer the input it gets, in the order it gets it. This would be stored in some kind of volatile memory. The control unit then sends out the data from the buffer in the order in which it is desired. Usually the size of each buffer would be that of the data that the input generates in one time slice.

We do not have to confine ourselves to a single type of switch. There can be switches that are based on a combination of both kinds of switching. For example, we could have a multistage switch where, some of the stages are space division switches while others are time division switches. With such an approach, we can try to optimise the design by reducing the need for cross points while keeping the delays in the whole system to a minimum. For example, we could have a TST three stage switch where the first and last stages use time division switching while the middle stage uses cross points.

Circuit switching is useful for voice-based communication because of the characteristics of the data transfer. Although, a voice conversation tends to have periods of silence in between, those periods are usually brief. The rest of the time there is data available for transmission. Secondly, in such communication, we cannot tolerate delays of more than about 100ms as that becomes perceptible to the human ear and is quite annoying to the speaker and listener.

Again, because it is human beings that are present at both ends, the rate at which data is generated at both ends is similar, even if one person talks a bit faster than the other! Also, the other human can usually understand what is being said even if he cannot at the same rate. And if really required, one can communicate to the other to speak slower or louder. But, when we are dealing with data generating devices, there can always be a mismatch between the rate at which one device generates data and at

which the other device can assimilate it. Moreover, there can be long periods when there is no data generated at all for transmission. In such a situation, circuit switching will not be a suitable method and we have to look at something that takes care of the characteristics of data communication between devices.

### 3.4.2 Packet Switching

Packet switching [Figure 1.55](#) is a method of addressing these problems of circuit switching. It is based on the concept of data packets, called datagrams. These are self-contained units that include the address of the destination, the actual data and other control information. It takes care of the sporadic nature of data communication where transmissions tend to occur in bursts. So, we do not waste transmission capacity by keeping circuits connected but, idle while there are periods of silence. Even if we multiplex the channel, we cannot cater to a situation where all or most of the devices are silent, leading to underutilization of the capacity. The concept is so interesting that it is worth devoting few words to it.

Whenever a user wants to send a packet to another user, **the packet is** transmitted to the nearest router either on its own LAN or over a point-to-point link to the router. The packet is stored for verification and then transmitted further to the next router along in way until it reaches for fixed destination machine. This mechanism is called packet switching.

Some of the other limitations of circuit switching for sending data are:

It is not possible to prioritise a transmission. In a circuit switching mechanism, all the data will be sent in the order in which it is generated, irrespective of its importance or urgency. This is for voice transmission, in which we want to hear things in the sequence in which they are spoken at the other end, but this does not work for data where, some packets may be more important than others and the order of delivery does not have to be sequential.

A circuit, once set up, defines the route that will be taken by the data until it is dismantled and set up again. Sometimes, that circuit may have been set up via a less advantageous set of links because that was the best route available at the time it was set up (best could be in terms of channel capacity, delays, line quality or other parameters). Now, subsequently, even if another, better route is released by other devices, we cannot change over to this better route without disconnecting the previous circuit and forcing the participants to set up the call again.

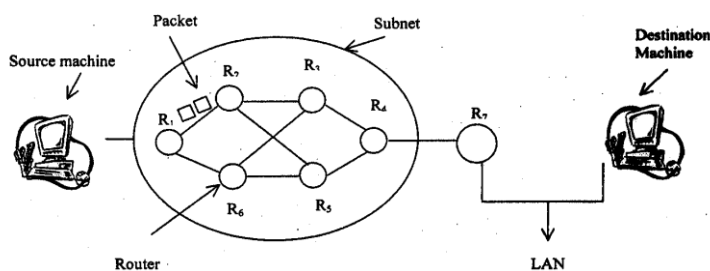

**Figure 1.55:** Packet switching

A datagram can contain different lengths of data. Besides, it would have control information such as the address to which it needs to be sent, the address from which it has originated, its type and priority and so on. From its source node it is sent to a neighbouring node, depending on its final destination. The format of the datagram depends on the protocol that is used and it is the responsibility of each node to route the datagram onto the next node that would take it to its destination. There can be several routes possible and each node would make the decision based on availability, traffic conditions, channel quality and so on.

Although datagram length can vary, long messages would have to be split into more than one datagram as the network protocol would have a limit on the maximum size of a datagram. Because each datagram is routed independently, the different datagrams that make up a message may arrive out of sequence at the destination, as different routes may take different times to traverse. In communication protocols it is the responsibility of the network layer to make sure that routing gets done, while it is the transport layer that ensures that the message at the receiving end is in the proper sequence.

Again, the physical link between two nodes can be of any type and is of no consequence at the higher layers of the communication protocol in use. That link itself may be multiplexed and may carry several transmissions simultaneously, for the same or different pairs of source and destination nodes. Moreover, these transmissions may be happening in different directions.

This was the datagram approach to packet switching. It is also possible to look at packet switching in terms of a virtual circuit, which again has two different approaches that are in current practice.

In a virtual circuit, when the first datagram is sent out, we decide on the route that will be followed, and subsequent datagrams continue to follow that route. So, it is like circuit switching to a large extent. But, in circuit switching the link is dedicated to the pair of nodes and there is no multiplexing that happens at the level of individual switches. In virtual circuits there can be multiplexing at the switches as well.

Permanent virtual circuits are dedicated channels set up for communication between a pre-decided pair of nodes. It is thus, akin to a leased line where the routing is decided once the virtual circuit is set up. There is no call set up required because, the link is always available to the pair of nodes. On the other hand, we can also have switched virtual circuit where the routing is decided every time a pair of nodes want to communicate. This is like a dial-up connection where any two pairs of nodes can communicate by setting up a call that is terminated when the conversation is over.

Another difference between circuit and virtual circuit switching has to do with reliability and failure recovery. In circuit switching, if the link breaks because of a failure in any portion, the call is terminated. It would have to be established again for the conversation to continue. In virtual circuits, although the route is decided at the beginning when the session is set up, in case of failure of any part of the route, an alternate route will be agreed upon and set up.

Also, in circuit switching there is no possibility of failure due to congestion after the link is set up. In virtual circuits, congestion can occur even later because of multiplexing at the switches.



#### **4.0 CONCLUSION**

This unit has extensively described the basic concepts behind multiplexing and switching. You have learnt how a telephone line can be used for transmitting data using ADSL and also the differences between ADSL and cable television for data access.

You have also learnt about the characteristics of frequency Division Multiplexing and the features of Time Division Multiplexing both synchronous and statistical different kinds of switching.



#### **5.0 SUMMARY**

Multiplexing is needed in communication networks because of the scarcity of bandwidth compared to the large number of users. Frequency Division and Time Division Multiplexing are the two ways of multiplexing, of which Time Division Multiplexing can be synchronous or asynchronous. The asynchronous method is more complex but more efficient for data transmission.

ADSL is a means of utilising the existing capacity of the local loop in the telephone system for providing subscribers with high speed data access. Such access is also provided by companies over the cable television network. ADSL is more secure and predictable in terms of service quality, while cable does not have the limitations of distance from the end office that ADSL has.

Switching is necessary to connect two nodes or devices over the network that intends to communicate for a limited duration. Circuit switching is more suitable for voice communication, and can be done using space division, time division or a combination of both kinds of switches. Multistage switching is needed to optimise the number of cross points needed. Packet switching is used for data transmission and allows for prioritising of data packets, alternate routing as needed and is also more efficient for the busy traffic pattern of data communication. Datagrams are self-contained packets of data that are routed by the intermediate nodes of the network. Switched or permanent virtual circuits can also be utilised, where the route is established at the beginning of the session, but can be altered without disrupting the channel in case of failure of any part of the route.



#### **6.0 TUTOR MARKED ASSIGNMENT 4**

1. Describe the need for switching and define a switch.
2. List the three traditional switching methods. What are the most common today?
3. What are the two approaches to packet-switching?

4. Compare and contrast a circuit-switched network and a packet-switched network.
5. What is the role of the address field in a packet traveling through a datagram network?
6. What is the role of the address field in a packet traveling through a virtual circuit network?
7. Compare space-division and time-division switches.
8. What is TSI and its role in a time-division switching?
9. Define blocking in a switched network.
10. List four major components of a packet switch and their functions.



## 7.0 REFERENCES/FURTHER READINGS

Andrew.S. Tannenbaum, *Computer Networks*, PHI, New Delhi, 2011

William Stalling, *Data and Computer Communication*. PHI, New Delhi, 2003.

Behrouz Forouzan, (2016). *Introduction to Data Communications and Networking*  
Tala McGraw-Hill, New Delhi.

## 8.0 ANSWER TO TUTOR MARKED ASSIGNMENT 4

### Question 1

Describe the goals of multiplexing.

Solution

**Multiplexing** is the set of techniques that allows the simultaneous transmission of multiple signals across a single data link.

### Question 2

Distinguish between a link and a channel in multiplexing.

Solution

In **multiplexing**, the word **link** refers to the physical path. The word **channel** refers to the portion of a link that carries a transmission between a given pair of lines. One link can have many (n) channels.

### Question 3

Which of the three multiplexing techniques is common for fibre optic links? Explain the reason

### Solution

Wavelength Division **Multiplexing (WDM)** is common of the three types of multiplexing (Frequency Division **Multiplexing (FDM)**, Wavelength Division **Multiplexing (WDM)** and Time Division **Multiplexing (TDM)**) for multiplexing *optical signals* because it allows the multiplexing of signals with a very high frequency.

### **Question 4**

Distinguish between synchronous and statistical TDM

### Solution

In *synchronous TDM*, each input has a reserved slot in the output frame. This can be inefficient if some input lines have no data to send. In *statistical TDM*, slots are dynamically allocated to improve bandwidth efficiency. Only when an input line has a slot's worth of data to send is it given a slot in the output frame.

### Question 5

Assume that a voice channel occupies a bandwidth of 4 kHz. We need to multiplex 10 voice channels with guard bands of 500 Hz using FDM. Calculate the required bandwidth.

### Solution

To multiplex 10 voice channels, we need nine guard bands. The required bandwidth is then  $B = (4 \text{ KHz}) \times 10 + (500 \text{ Hz}) \times 9 = \mathbf{44.5 \text{ KHz}}$

### Question 6

Describe the need for switching and define a switch.

### Solution

*Switching* provides a practical solution to the problem of connecting multiple devices in a network. It is more practical than using a bus topology; it is more efficient than using a star topology and a central hub. Switches are devices capable of creating temporary connections between two or more devices linked to the switch.

### Question 7

What are the two approaches to packet-switching?

### Solution

There are two approaches to packet switching: *datagram approach* and *virtual circuit approach*.

### Question 8

What is the role of the address field in a packet traveling through a datagram network?

### Solution

The address field defines the *end-to-end* (source to destination) addressing.

### Question 9

Compare space-division and time-division switches.

### Solution

In a *space-division* switch, the path from one device to another is spatially separate from other paths. The inputs and the outputs are connected using a grid of electronic microswitches. In a *time-division* switch, the inputs are divided in time using TDM. A control unit sends the input to the correct output device.

### Question 10

Define blocking in a switched network.

### Solution

In multistage switching, *blocking* refers to times when one input cannot be connected to an output because there is no path available between them—all the possible intermediate switches are occupied. One solution to blocking is to increase the number of intermediate switches based on the Clos criteria.

### Question 11

A path in a digital circuit-switched network has a data rate of 1 Mbps. The exchange of 1000 bits is required for the setup and teardown phases. The distance between two parties is 5000km. Answer the following questions if the propagation speed is  $2 \times 10^8$  m/s:

- What is the total delay if 1000 bits of data are exchanged during the data transfer phase?
- What is the total delay if 100,000 bits of data are exchanged during the data transfer phase?
- What is the total delay if 1,000,000 bits of data are exchanged during the data transfer phase?
- Find the delay per 1000 bits of data for each of the above cases and compare them. What can you infer?

### Solution

We assume that the setup phase is a two-way communication and the teardown phase is a one-way communication. These two phases are common for all three cases. The delay for these two phases can be calculated as three propagation delays and three

transmission delays or  $3 [(5000 \text{ km}) / (2 \times 10^8 \text{ m/s})] + 3 [(1000 \text{ bits}) / (1 \text{ Mbps})] = 75 \text{ ms} + 3 \text{ ms} = 78 \text{ ms}$ . We assume that the data transfer is in one direction; the total delay is then delay for setup and teardown + propagation delay + transmission delay

a.  $78 + 25 + 1 = 104 \text{ ms}$

b.  $78 + 25 + 100 = 203 \text{ ms}$

c.  $78 + 25 + 1000 = 1103 \text{ ms}$

d. In case a, we have 104ms. In case b we have  $203/100 = 2.03 \text{ ms}$ . In case c, we have  $1103/1000 = 1.103 \text{ ms}$ . The ratio for case c is the smallest because we use one setup and teardown phase to send more data.



## MODULE 2: MEDIA ACCESS CONTROL AND DATA LINK LAYER

Unit 1	Data Link Layer Fundamentals
Unit 2	Retransmission Strategies
Unit 3	Contention-Based Media Access Protocols
Unit 4	Wireless LAN and Datalink Layer Switching

### UNIT 1 DATA LINK LAYER FUNDAMENTALS

#### CONTENTS

1.0	Introduction
2.0	Objectives
3.0	Main Content
	3.1 Framing
	3.2 Basics of Error Detection
	3.3 Forward Error Correction
	3.4 Cyclic Redundancy Check Codes for Error Detection
	3.5 Flow Control
4.0	Conclusion
5.0	Summary
6.0	Tutor-Marked Assignment
7.0	References/Further Readings



#### 1.0 INTRODUCTION

Data Link Layer (DLL) is the second layer of the OSI model which takes services from the Physical layer and provides services to the network layer. DLL transfers the data from a host to a node or a node to another node.

The main task of the data link layer is to take a raw data from transmission facility and transform it into a line that appears free of transmission errors to the network layer. Data packets are encoded and decoded into bits. These are called frames. The Functions of the Data Link Layer are Framing, Frame synchronisation, Error Handling Flow Regulation, Addressing and Access Control. The data link layer is divided into two sublayers: The Media Access Control (MAC) layer and the Logical Link Control (LLC) layer. The MAC sublayer controls how a computer on the network gains access to the link resources and grants permission to transmit it. The LLC layer controls frame synchronisation, flow control and error checking.

Frame is a data structure used in transmissions at DLL consisting of a header and a trailer bracketing a data frame. Packets are the fundamental unit of information transport in all modem computer networks, and increasingly, in other communication networks as well these are converted to frame at DLL. The destination host not receiving the data bits as transmitted by the source host is termed as error in data. The error needs to be detected or corrected, as the data on the network must be error free and reliable which is one of the key features of the DLL. There are various methods used for detection and correction of these errors viz.: FEC (Forward Error Correction) and CRC (Cyclic Redundancy Check). To transmit data from a source to a destination node, a node in a network should be uniquely identified. This identification is known as the address of the node. Access

control is related to addressing the problem of “Which channel or node on a LAN or WAN would transmit data?” The data link layer also deals with the problem of difference in the speed of transmission of data by the sender and receiver. Very often the speed of the receiver is slower than the speed of the sender. To overcome the same, the DLL has many flow control mechanisms as part of its functionality.



## 2.0 OBJECTIVES

After going through this unit, you should be able to understand:

1. the functionality of the Data Link Layer
2. the concept of framing and how framing is done
3. the types of errors that can be generated in frames during transmission
4. error in a data frame method;
5. for detecting errors methods,
6. for correcting errors
7. forwarding the error correction method for error correction following the CRC method for error detection the meaning of flow controls the methods for Managing Flow Control and error control.



## 3.0 MAIN CONTENT

### 3.1 Framing

As you already know, the physical layer deals with raw transmission of data in the form of bits and gives services to the data link layer. The data link layer provides services to the network layer as shown in the **Figure 2.1**:

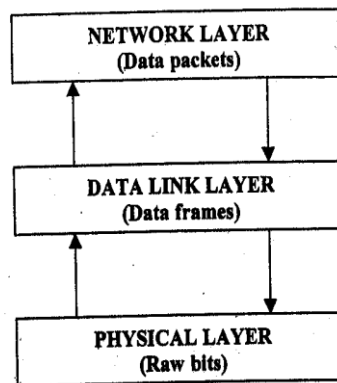

**Figure 2.1: Data link layer providing services to network layer**

The raw data coming from the Physical layer is converted into frames for forwarding to the network layer. This is done to ensure that the transmission of data is error free. Error detection and correction (if required) is done by the Data link layer, which is discussed in the following sections. The structure of the frame is shown in **Figure 2.2**.

Converting the bit stream into frames is a tedious process. The beginning and end of each frame should be explicitly marked. The easiest way to do so is to insert some time gap between frames.

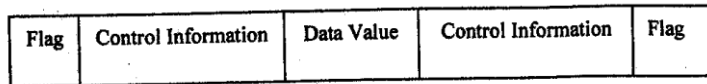

**Figure 2.2: Frame format**

But it is difficult to keep track of counts on timing to mark the start and end time of each frame. So, to overcome the same, we will discuss the following methods for framing.

1. Character Count
2. Character Patterns
3. Bit Patterns
4. Framing by Illegal code (code violation)

### 3.1.1 Character Count

The first framing method, Character count, uses a header field to specify the number of characters in the frame. The Data Link Layer at the destination checks the header field to know the size of the frame and hence, the end of frame. The process is shown in *Figure 2.3* for a four-frame of size 4,5,5 and 9 respectively.

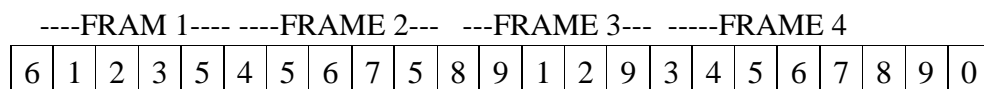

**Figure 2.3: Character count**

However, problems may arise due to changes in character count value during transmission. For example, in the first frame if the character counts 4 changes to 6, the destination will receive data out of synchronisation and hence, it will not be able to identify the start of the next frame. This example is shown in *Figure 2.4*. Even, after a request from the destination to the source for retransmission comes, it does not solve the problem because the destination does not know from where to start retransmission.

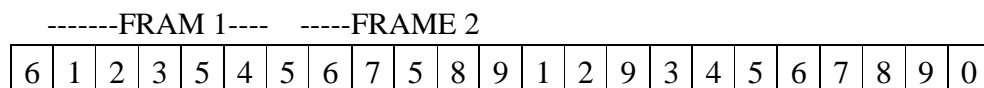

ERROR-----DATA Received Out of Order -----

**Figure 2. 4: Problem in character count**

### 3.1.2 Character Patterns

The **second** framing method, Character stuffing, solves the problem of out of synchronisation. Here, each frame starts with special character set e.g., a special ASCII character sequence.

The frame after adding the start sequence and the end sequence is shown in **Figure 2.5**.

Begin each frame with DLE STX. End each frame with DLE ETX.

DLE stands for Data Link Escape

STX stands for Start of Text

ETX stands for End of Text

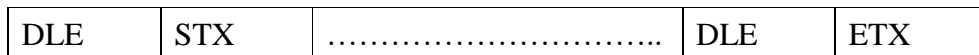

**Figure 2. 5:** Character patterns (Character stuffing)

If a OLE ETX occurs in the middle of the data and interferes with the data during framing then, insert an ASCII OLE character just before DLE character in the data. The Receiver interprets the single DLE as an escape indicating that the next character is a control character.

If two OLE's appear in succession at the receiver's end, the first is discarded and the second is regarded as data. Thus, framing OLE STX or OLE ETX is distinguished by whether OLE is present once or twice.

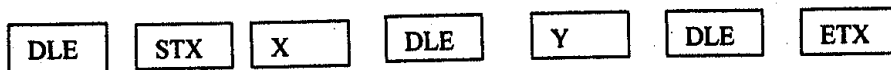

**Figure 2.6a:** Before stuffing



**Figure 2.6b:** After stuffing



**Figure 2.6c:** After destuffing

A problem with character stuffing is that not all bit streams are character oriented (e.g., Unicode is a 16-bit code). Hence, for arbitrary sized characters the process of character stuffing becomes more complex. So next we will discuss a new method known as the bit stuffing, which solves the problem of arbitrary sized character.

### 3.1.3 Bit Patterns

This method is similar to the one discussed in section 3.1.3, except that, the method of bit stuffing allows insertion of bits instead of the entire character (8 bits). Bit pattern framing uses a particular sequence of bits called a *flag* for framing. The flag is set as the start and the end of the frame.

Use of *bit patterns* is to keep the sequence of data in the same order.

Flag = 0 111111 0 (begins and ends frame.)

In this case the transmitter automatically inserts a 0 after 5 consecutive 1's in the data. This is called Bit stuffing. The receiver discards these stuffed 0's as soon as it encounters 5 consecutive 1's in the received data as shown with the help (If an example described in Figure 2.7 (a), (b) and (c)).

11111111110010011

Figure 2.7 (a): Original' data ready to be sent

01111110111110111110001001101111110

Figure 2.7(b): Data after adding Flag and stuffing

11111111110010011

Figure 2.7(c): Data after destuffing

### Framing by Illegal Code (Code violation)

A fourth method is based on any redundancy in the coding scheme. In this method, we simply identify an illegal bit pattern, and use it as a beginning or end marker, i.e., certain physical layers use a line code for timing reasons.

For example: Manchester Encoding

1-It can be coded into two parts i.e., high to low  = 1 0

0 -It can be coded into two parts i.e., low to high  = 0 1

Codes of all low (000) or all high (111) aren't used for the data and therefore, can be used for framing.

### SELF EXERCISE ASSIGNMENT 6

- 1 Name different framing methods.
- 2 Write the bit sequence after bit stuffing for the data stream 11000111111100001111100.
- 3 Why bit stuffing advantageous over character stuffing?

## 3.2 Basics of Error Detection

The Network should ensure complete and accurate delivery of data from the source node to destination node. But many times data gets corrupted during transmission. As already discussed in the previous block, many factors can corrupt or alter the data that leads to an error. A reliable system should have methods to detect and correct the errors. Firstly, we will discuss what the error could be then, in the later section we will discuss the process of detecting and correcting them.

### 3.2.1 Types of Error

Several types of error may occur during transmission over the network:

1. 1-bit error
2. burst error
3. lost message (frame)

**1-bit error:** 1-bit error/Single bit error means that only one bit is changed in the data during transmission from the source to the destination node i.e., either 0 is changed to 1 or 1 is changed to 0 as shown in [Figure 2.8](#).

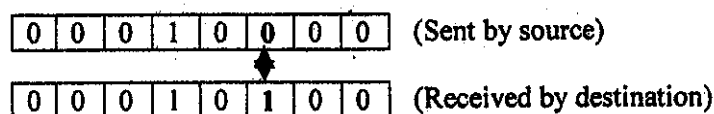

[Figure 2.8](#): 1bit error

This error will not appear generally in case of serial transmission. But it might appear in case of parallel transmission.

**Burst error:** Burst error means that 2 or more bits of data are altered during transmission from the source to the destination node. But, it is not necessary that error will appear in consecutive bits. Size of burst error is from the first corrupted bit to the last corrupted bit as shown in [Figure 2.9](#).

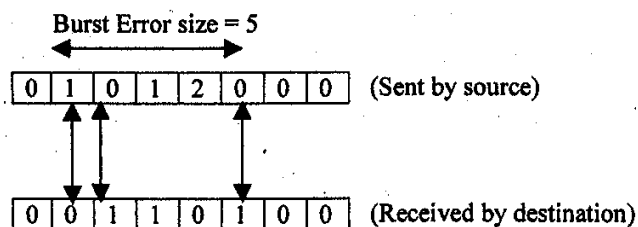

[Figure 2.9](#): Burst error

An n-bit burst error is a string of bits inverted during transmission. This error will hardly occur in case of parallel transmission. But, it is difficult to deal with all corrupted bits at one instance.

## Lost Message (Frame)

The sender has sent the frame but that is not received properly, this is known as loss of frame during transmission. To deal with this type of error, a retransmission of the sent frame is required by the sender. We will discuss retransmission strategies in the next unit. Now we will discuss some methods for error detection.

### 3.2.2 Error Detection

As already discussed in the beginning of this section accurate delivery of data at the receiver's site is, one of the important goals of this layer. This implies that the receivers should get the data that is error free. However, due to some factors if, the data gets corrupted, we need to correct it using various techniques. So, we require error detection methods first to detect the errors in the data before correcting it. Error detection is an easy process.

For error detection the sender can send every data unit twice and the receiver will do a bit by bit comparison between the two sets of information. Any alteration found after the comparison will, indicate an error and a suitable method can be applied to correct the error.

But, sending every data unit twice increases the transmission time as well as overhead in comparison. Hence, the basic strategy for dealing with errors is to include groups of bits as additional information in each transmitted frame, so that, the receiver can detect the presence of errors. This method is called Redundancy as extra bits appended in each frame are redundant. At the receiver end these extra bits will be discarded when the accuracy of data is confirmed. **The illustration is in Figure 2.10**

For example:

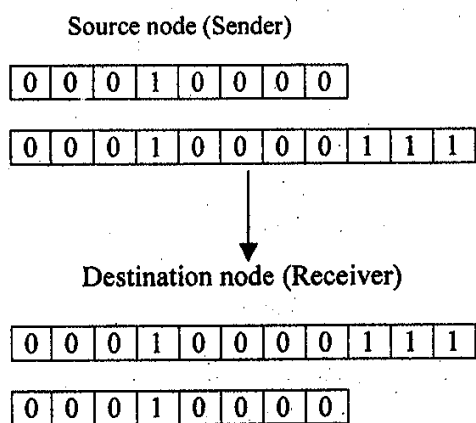

**Figure 2.10 : Error Detection**

Redundancy check methods commonly used in data transmission are:

1. Parity check
2. CRC
3. Checksum

## Parity Check

The most common method used for detecting errors when the number of bits in the data is small, is the use of the *parity bit*.

A *parity bit* is an extra binary digit added to the group of data bits, so that, the total number of one's in the group is even or odd.

Data bits in each frame is inspected prior to transmission and an extra bit (the parity bit) is computed and appended to the bit string to ensure even or odd parity, depending on the protocol being used.

If odd parity is being used, the receiver expects to receive a block of data with an odd number of 1's.

For even parity, the number of 1's should be even.

In the example below, even parity is used. The ninth column contains the parity bit.

```
010101010
011110011
111100110
```

Use of parity bits a rather weak mechanism for detecting errors.  
A single parity bit can only detect single-bit errors.

## Block Sum Check Method

This is an extension to the single parity bit method. This can be used to detect up to two bit errors in a block of characters.

Each byte in the frame is assigned a parity bit (*row parity*).

An extra bit is computed for each bit position (*column parity*). The resulting set of parity bits for each column is called *the block sum check*. Each bit that makes up the character is the modulo-2 sum of all the bits in the corresponding column.

Block Sum Check, example

**Sender's data:** 0000100 0010101 0101011

```
1 0000100
1 0010101
00 010111
00 111010
```

**Data after adding parity bits:**

00001000 00101010 01010110 01110100



This method detects single bit errors as well as increases the probability of finding burst error.

## CRC

***Cyclic Redundancy Check (CRC) is used to detect burst errors***

In this method, you would need to treat strings of bits as coefficients of a polynomial code that uses modulo 2 arithmetic. In modulo 2 arithmetic there are no carries for addition and borrows for subtraction. Polynomial codes treat bit strings as representative of polynomials with coefficients of 0 and 1 only.

For example, the bit sequence 100101 is represented by the polynomial  $x^5 + x^2 + 1$  ( $1.x^5 + 0.x^4 + 0.x^3 + 1.x^2 + 0.x^1 + 1.x^0$ ). When the polynomial method is employed, the sender and the receiver must agree upon a generator polynomial both the high and low order bits of the generator must be 1.

In this method the Sender divides frame (data string) by a predetermined Generator Polynomial and then appends the remainder (called checksum) onto the frame before starting the process of transmission. At the receiver end, the receiver divides the received frame by the same Generator polynomial. If the remainder obtained after the division is zero, it ensures that data received at the receiver's end is error free. All operations are done modulo 2.

An example that explains finding CRC (Cyclic Redundancy Check) will follow later.

### Checksum

In this method the checksum generator divides the given input data into equal segments of k bits (8 or 16). The addition of these segments using ones complement arithmetic is complimented. This result is known as the checksum and it is appended with the data stream. This appended data stream is transmitted across the network on the transmission media. At the receiver end, add all received segments. If the addition of segments at the receiver end is all 1's then, the data received is error free as, complement of the same will be all 0's. Then the data can be accepted, otherwise, data can be discarded.

**For example:**

Sender's data	00000010	01010000
	00000010	
	<u>01010000</u>	Sum
	<u>01010010</u>	

**Checksum (Compliment) 10101101**

**Data with appended checksum: 00000010 01010000 10101101**

**Receiver's accept the data as**

**00000010 01010000 10101101**

**At receiver's end**

```
00000010
01010000
10101101 sum
11111111
```

**Complement 00000000**

As complement is 0 it indicates that the data received at the receiver's end is error free so, it will be accepted by the receiver.

The checksum method detects all errors as it retains all its carries.

Odd number of bits Most of  
even number of bits.

### **3.3 Forward Error Correction**

In the previous section we have discussed detection of error that appears after the transmission of data over the network from sender to receiver. In this section, we will study how to perform correction of errors. Forward Error Correction (FEC) is a type of error correction method which improves on simple error detection schemes by enabling the receiver to correct errors once they are detected. This reduces the need for retransmissions of error frames.

Firstly we consider the simple case i.e., correcting single bit error. As we have discussed earlier that a single bit error can be detected by adding one additional bit (parity bit! redundant bit). This additional bit can detect error in any bit stream by differentiating the two condition error or not error as a bit can have two states only i.e., 0 and 1.

For correction of detected single bit error two states are not sufficient. As an error occurs in bit stream indicates that one bit is altered from either 0 to 1 or 1 to 0. To correct the same, conversion of altered bit is required. For performing this conversion we must know the location of bit which is in error. Therefore, for error correction identification of location of error bit is required. For example, for applying error correction of single bit error in ASCII character we must find which of 7 bit is altered. For doing this we could have eight different states i.e., no error, error in bit position 1, error in bit position 2 up to error in bit position 7. For this we need many redundant bits to represent all eight states.

Here, 3bit redundancy code can represent all possible eight states because 3 bits can represent 8 states (000 to 111). But if an error occurs in redundancy bit then we need

3 Additional bits added with 7 ASCII character bits, it covers all possible error locations.

So we can generalise if we have  $n$  data bits and  $r$  redundancy bits then total  $n+r$  will be the transmittable bits and  $r$  bits must be able to represent at least  $n+r+1$  different states, here plus 1 indicates no error state. Hence  $n+r+1$  states are identifiable by  $r$  additional bits and  $r$  additional bits represents  $2^r$  different states.

$$2^r \geq n+r+1$$

For example, in 7bit ASCII character we need at least 4 redundant bits as  $2^4 \geq 7+4+1$ .

Hamming code is one such error correcting code.

For the example discussed above for a 7bit ASCII character and 4 redundant bit, we will have total bits as  $n+r$  i.e.,  $7+4 = 11$ . These 4 redundant bits can be inserted in 7 bit data stream in position 1,2,4 and 8 (in II bit sequence at  $2^0, 2^1, 2^2, 2^3$ ) named as  $r_1, r_2, r_4$  and  $r_8$  respectively.

In Hamming code each redundant bit is the combination of data bits where each data bit can be included in more than one combination as shown below.

$r_1$ : 1,3,5,7,9,11  $r_2$ :  
 2,3,6,7,10,11  $r_4$ : 4,5,6,7  
 $r_8$ : 8,9,10,11

Now we will find the values of redundant bit  $r_1, r_2, r_4$  and  $r_8$  for the data bit sequence 1010101 as shown in following **Figure 2.11**.

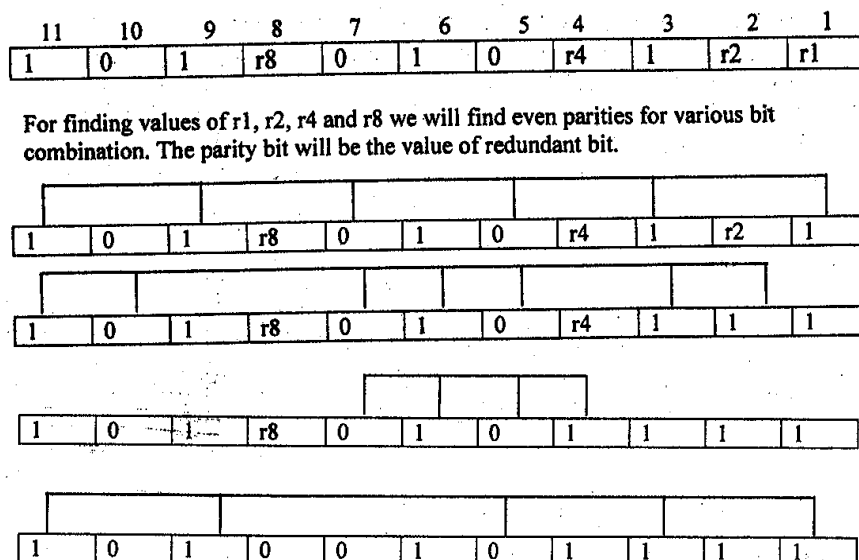

**Figure 2.11: Forward Error Correction**

Assume that during transmission tile number 5 bit is altered from 0 to I, So, at receiver end for error detection and correction new parities will be calculated as earlier. Hence, the result of Figure 2.12.

1	0	1	0	0	1	1	1	1	1	1	1
1	0	1	0	0	1	1	1	1	1	1	0
1	0	1	0	0	1	1	1	1	1	1	1
1	0	1	0	0	1	1	1	1	1	1	0

Figure 2.12: Error Correction

0101 = 5. It implies 5<sup>th</sup> bit is the error bit. The binary number obtained from new parities will indicate the error bit location in the received data stream. Subsequently that bit can be altered and data can be corrected.

If all the values in the new parity column are 0, we conclude that the data is error free. In the given example if no error it should be 0000.

### 3.4 Cyclic Redundancy Check Codes for Error Detection

The most commonly used method for detecting burst error in the data stream is Cyclic Redundancy Check Method. This method is based on the use of polynomial codes. Polynomial codes are based on representing bit strings as polynomials with coefficients as 0 and 1 only.

For example, the bit string 1110011 can be represented by the following polynomial:

$$1.x^6+1.x^5+.1.x^4+0.x^3+0.x^2'+1.x^1+1.x^0$$

This is equivalent to:

$$x_6 + x_5 + x_4 + x_1 + 1.$$

The polynomial is manipulated using modulo 2 arithmetic (which is equivalent to Exclusive OR or XOR).

Depending on the content of the frame a set of check digits is computed for each frame that is to be transmitted. Then the receiver performs the same arithmetic as the sender on the frame and check the digits. If the result after computation is the same then the data received is error free.

A different answer after the computation by the receiver indicates that, some error is present in the data.

The computed check digits are called the frame check sequence (FCS) or the cyclic redundancy check (CRC).

The CRC method requires that:

The sender and receiver should agree upon a generator polynomial before the transmission process start.

Both the high and low bits of the generator must be 1.

To compute the checksum for a frame with  $m$  bits, the size of the frame must be longer than the generator polynomial.

Algorithm for Computing the Checksum is as follows as:

Let  $D(x)$  be the data and  $G(x)$  be the generating polynomial. Let  $r$  be the degree of generator polynomial  $G(x)$ .

**Step 1:** Multiply the data  $D(x)$  by  $x^r$ , giving  $r$  zeros in the low-order end of the frame.

**Step 2:** Divide the result obtained in step 1 by  $G(x)$ , using modulo-2 division.

**Step 3:** Append the remainder from step 2 to  $D(x)$ , thus, placing  $r$  zeros in the  $r$  low-order positions.

The type of generating polynomial is important for finding the types of error that are detected.

A generator polynomial of  $R$  bits will detect:

1. all single-bit errors
2. all double-bit errors
3. all odd-number of bit errors
4. all burst errors  $< R$
5. most burst errors  $\geq R$

**Example:**

Data 1011101

Generator Polynomial  $G(x): x^4+x^2+1 = 10101$

Here the size of the generator polynomial is 5 bit long, so, we will place  $5 - 1 = 4$  0's in the low order data stream. So the data will be:

Data 10111010000

Now using modulo-2 division, (for getting data ready to be transmitted), we will divide the data by the generator polynomial as shown in the [Figure 2.13](#).

Division diagram at sender's site

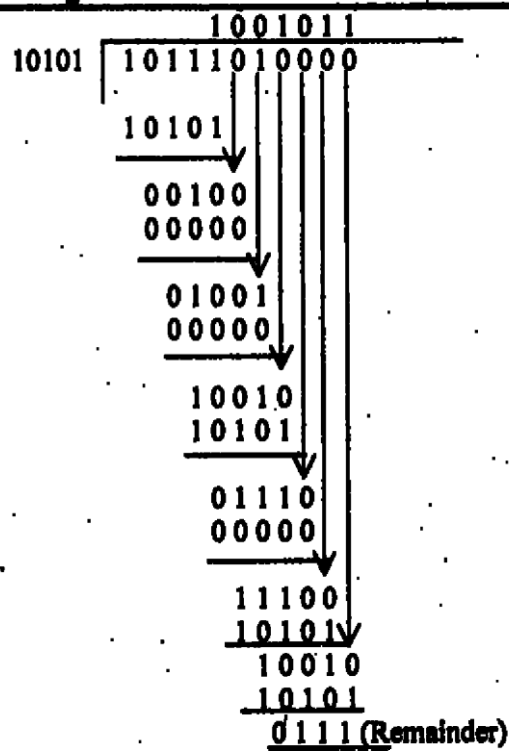

Figure 2.13: Cyclic redundancy check

The remainder obtained after the division of 011 1, will be placed on the low order bits of the data stream. So, the Data that is transmitted over the network by the sender is  $D(x) = 10111010111$

Now at the receiver's end, the receiver receives  $D(x)$  as data which will be divided by the generator polynomial as shown in Figure 2.14.

## Division diagram at receiver's site

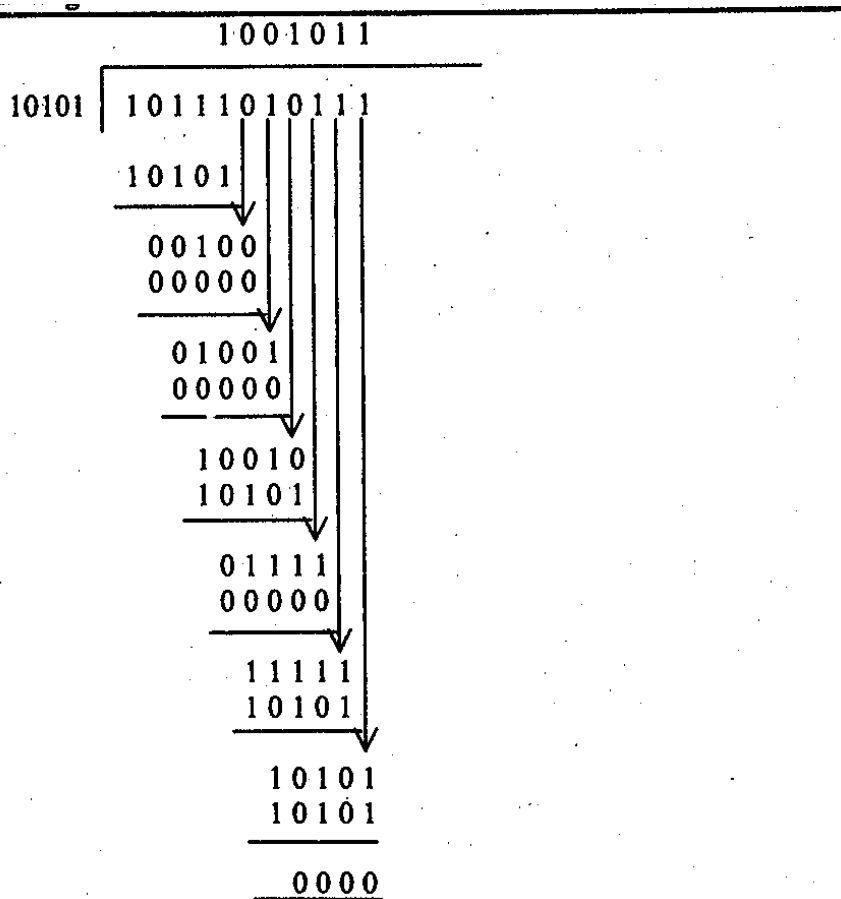

Figure 2.14: Cyclic redundancy check the receiver side

Here the remainder obtained after division is 0000, so it ensures that data received at the receiver end is error free otherwise, it indicates that the data has some error in it. In this way the CRC method can detect whether the data has some error or is error free.

### 3.5 Flow Control

Another important issue for the data link layer is dealing with the situation which occurs when the sender transmits frames faster than the receiver can accept or process them. If the sender is working on a fast machine and the receiver is working on a slow machine this situation may occur in the network. In this process of transmission, some of the frames might be lost as they were not processed by the receiver due to its low speed, while the sender might have through the transmission to be completely error free. To prevent this situation during transmission, a method is introduced called the Flow Control.

Flow control means using some feedback mechanism by which, the sender can be aware of when to the send next frame, and not at the usual speed of the sender. If the frame is accepted /processed by the receiver then only with the sender send the next frame. It may be said that the speed of the sender and the receiver should be compatible with each other, so that the receiver will receive or process all frames sent

by the sender as every receiver has a limited block of memory called the buffer, reserved for storing incoming frames.

There are several methods available for deciding when a sender should send one frame or the next frame. Flow control ensures that the speed of sending the frame, by the sender, and the speed of processing the received frame by the receiver are compatible.

There are two basic strategies for flow control:

- 1 Stop-and-wait
- 2 Sliding window.

We shall start with the assumption that the transmission is error free and that we have an ideal channel.

### 3.5.1 Stop and Wait

Stop-and-Wait Flow Control (Figure 2.15) is the simplest form of flow control. In this method, the receiver indicates its readiness to receive data for each frame, the message is broken into multiple frames. The Sender waits for an ACK (acknowledgement) after every frame for a specified time (called time out). It is sent to ensure that the receiver has received the frame correctly. It will then send the next frame only after the ACK has been received.

#### Operations:

- 1 **Sender:** Transmits a single frame at a time.
- 2 **Receiver:** Transmits acknowledgement (ACK) as it receives a frame.
- 3 Sender receives ACK within time out.
- 4 Go to step I.

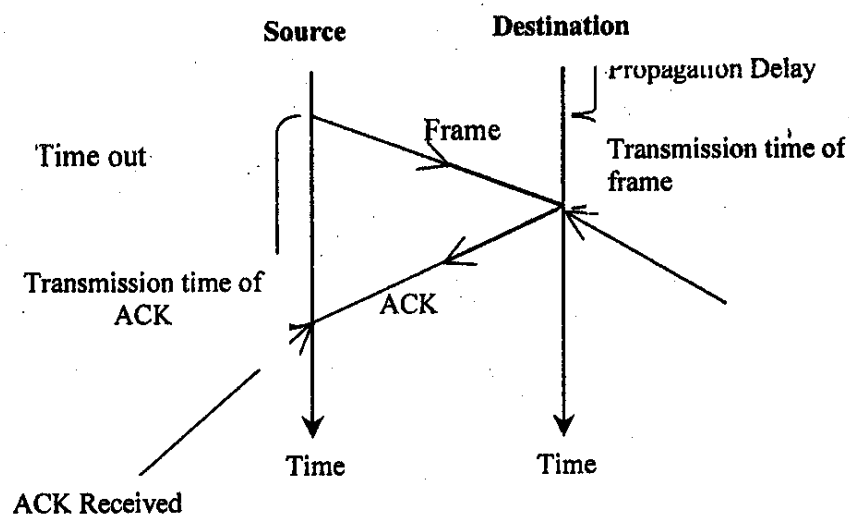

Figure 2.15: Stop and Wait

If a frame or ACK is lost during transmission then it has to be transmitted again by the sender. This retransmission process is known as ARQ (automatic repeat



request). Stop and Wait ARQ is one of the simplest methods of flow control. It will be further discussed in detail in the next unit.

**The problem with stop and wait is that** only one frame can be transmitted at a time and that often leads to inefficient transmission channel till we get the acknowledgement the sender can not transmit any new packet. During this time both the sender and the channel are unutilised.

To deal with this problem, there is another flow control method i.e., sliding window protocol which is discussed below:

### 3.5.2 Sliding Window Protocol

In this flow control method, the receiver allocates buffer space for  $n$  frames in advance and allows transmission of multiple frames. This method allows the sender to transmit  $n$  frames without an ACK. A  $k$ -bit sequence number is assigned to each frame. The range of sequence number uses mod $2^k$  arithmetic. To keep track of the frames that have been acknowledged, each ACK has a sequence number. The receiver acknowledges a frame by sending an ACK that includes the Sequence number of the **next expected frame**. The sender sends the next  $n$  frames **starting with** the last received sequence number that has been transmitted by the receiver (ACK). Hence, a single ACK can acknowledge multiple frames as shown in the [Figure 2.16](#).

The receiver receives frames 1,2 and 3. Once frame 3 arrives ACK4 is sent to the sender. This ACK4 acknowledge the receipt of frame 1,2 and 3 and informs the sender that the next expected frame is frame 4. Therefore, the sender can send multiple back-to-back frames, making efficient use of the channel.

## Normal Flow diagram of a sliding window

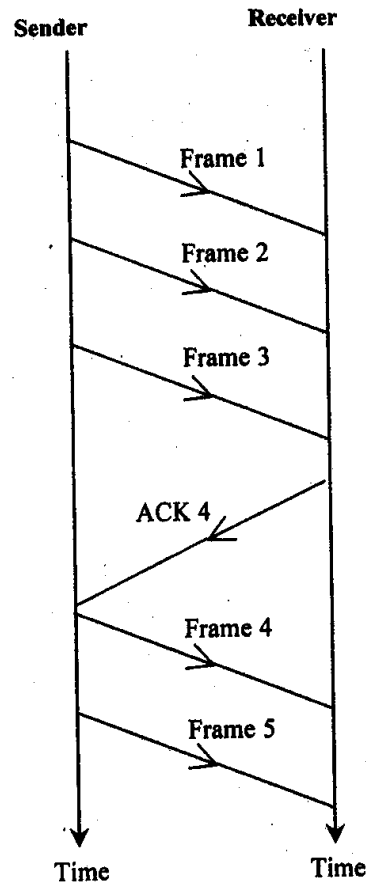

Figure 2.16: Normal flow diagram of sliding

Sequence number is a field in the frame that is of finite size. If  $k$  bits are reserved for the sequence number, then the values of sequence number ranges from 0 to  $2^k - 1$  (Modulo Arithmetic).

### Operation of a Sliding Window

#### Sending Window

In this mechanism we maintain two types of windows (buffer) sending window and receiving windows as shown in Figure 2.17 & 2.18.

At any instant, the sender is permitted to send frames with sequence numbers in a certain range (3-bit sending window) as shown in Figure 2.17

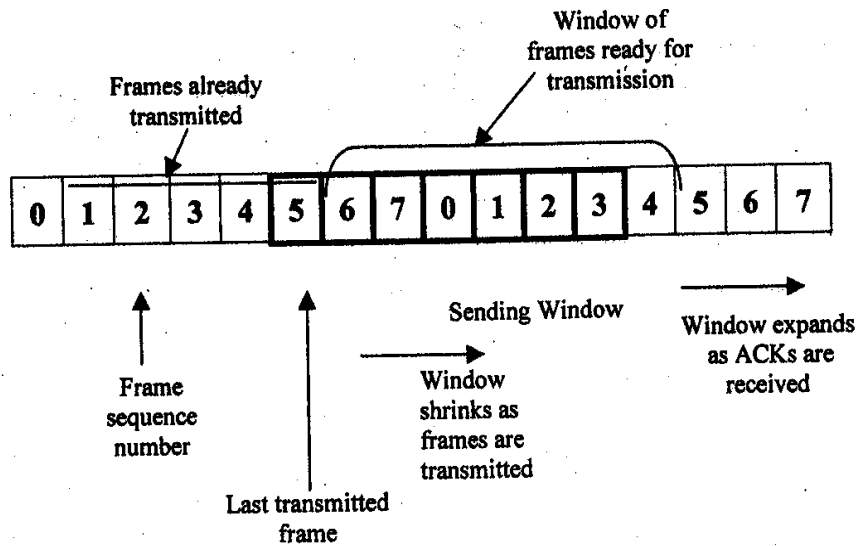

Figure 2.17: Sending Window in I Sliding Window

### Receiving Window

The receiver maintains a receiving window depending on the sequence numbers of frames that are accepted as shown in Figure 2.18.

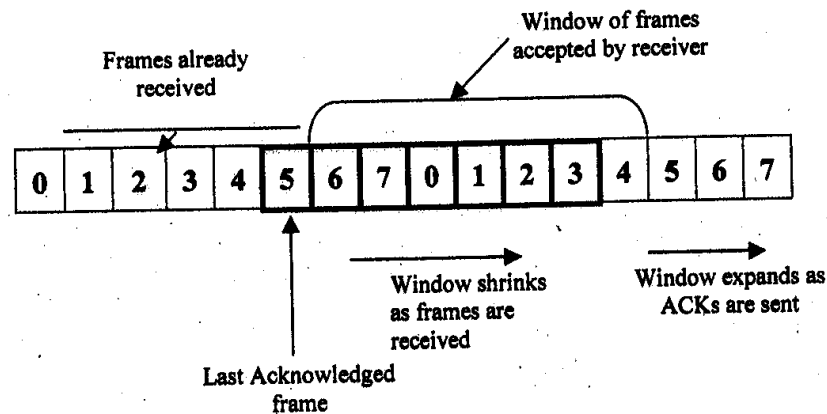

Figure 2.18: Receiving window in 1 sliding window

### Functioning of Sliding Window

Flow control is achieved as the receiver can control the size of the sending window by limiting the size of the sending window. Similarly, data flow from the sender to the receiver can be limited, and that too can controls the size of receiving window as explained with the help of an example in Figure 2.19.

## Example

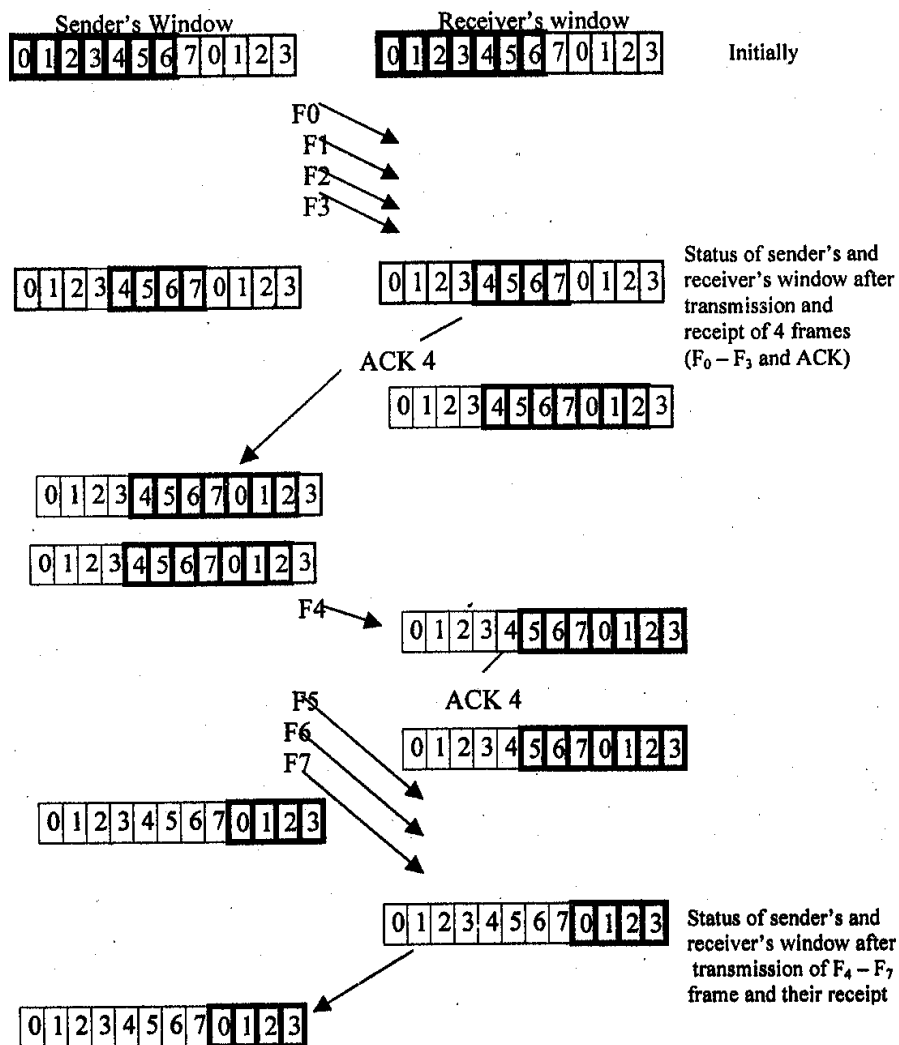

Figure 2.19: Function of a sliding window machine

Two types of errors are possible while transmission from source to destination takes place

1. Lost frame: Frame (data or control) fails to arrive.
2. Damaged frame: Frame is recognised, but some bits have been changed.

Two commonly used methods for sliding window are:

1. Go-back-n ARQ
2. Selective-repeat ARQ

Details of these two ARQ requests are discussed in the next unit.



## 4.0 CONCLUSION

In this unit we have described the elementary issues of the Data Link Layer such as how to divide data streams into frames. You have learnt the different types of errors that may occur. During the transmission of frames from the source node to the destination node, also detecting and correcting these errors. You have also learnt about flow control and the various methods for flow control.



## 5.0 SUMMARY

This unit introduced the basic fundamental issues related to the Data Link Layer. The concept of framing and different methods of framing like Character Count, Character Stuffing, Bit stuffing and Framing by Illegal code has been focused upon. In the Data Link layer, data flow and error control are discussed. This error and flow control is required in the system for reliable delivery of data in the network. For the same, different types of error, different methods for error detection and correction are discussed. Among various methods, Block sum check method detects burst of error with high probability. CRC method is the one which detects the error with simplicity. Forward Error Correction is the error correction method that uses the parity concept. For flow control, stop and wait method tries to ensure that the speed of the sender and the receivers are matching to an extent. To overcome this sliding Window protocol is introduced. Sliding window protocol can send many frames at one instance and that increases the efficiency of transmission channel. If some error occurs in the data then retransmission of the error frame is required and it is known as ARQ.



## 6.0 TUTOR MARKED ASSIGNMENT 5

1. Define parity bit? Also define even and odd parity?
2. Name the method that can detect single bit error and burst error.
3. Define checksum.
4. Define Hamming distance.
5. Generate the Hamming code for the following input data 101111
6. Find the CRC for the data polynomial  $x^3+X^2+X+ 1$  where generator polynomial is  $X^3+1$ .
7. How does the sliding window protocol increase the utilisation of bandwidth?
8. Define ARQ. How does ARQ facilitate the error control process?



## 7.0 REFERENCES/FURTHER READINGS

Andrew S. Tanenbaum, *Computer Networks*, 4<sup>th</sup> Edition, Prentice Hall of India, New Delhi.

William Stallings, *Data and Computer Communications*, 5<sup>th</sup> Edition, Pearson Education, New Delhi.

Behrouz A. Forouzan, *Data Communications and Networking*, 3<sup>rd</sup> Edition, Tata McGraw Hill, New Delhi.

## **8.0 ANSWERS TO TUTOR MARKED ASSIGNMENTS 5**

### **Question 1**

Define parity nit? Similarly define even and odd parity bit

#### **Solution**

A parity bit is the addition of a bit to a string of binary code which is used as the most elementary form of error detecting code. Even and odd parity bits are two different type of parity bits. The numbers of ones in a set of bits determine whether it is even or odd. For instance, given a set of decimal coded number (BCD) 100001, this has two “1s” which implies that is an even parity bit. Similarly, given 100101 which has three “1s” implies that it is an odd parity bit.

### **Question 2**

Name the method that can detect single bit error and burst error.

#### **Solution**

Single bit error correcting method is a technique of correcting single bit error while burst error technique is the method of correcting multiple (burst) error.

### **Question 3**

Define Checksum

#### **Solution**

A checksum is a small-sized datum derived from a block of digital data for the purpose of detecting errors that may have been introduced during its transmission or storage. By themselves, checksums are often used to verify data integrity but are not relied upon to verify data authenticity

### **Question 4**

Define Hamming Distance.

#### **Solution**

Hamming distance is the distance between two strings of equal length signifying the position in which the two strings are different.

### **Question 5**

Generate Hamming code for the following input data 101111

#### **Solution**

To generating Hamming code for the message 101111

We use the formula  $2^p \geq P+M+1$  formula

Where P = parity bit

M = message

$$2^p \geq p + 6 + 1$$

$$2^p \geq p + 7$$

Let p = 4

$$\text{Then } 2^4 \geq 4 + 7$$

$$24 > 4 + 7$$

$$16 > 11$$

So, we have

	$2^0$	$2^1$	$2^2$				$2^3$								$2^4$	
	1	2	3	4	5	6	7	8	9	10	11	12	13	14	15	16
	P <sub>1</sub>	P <sub>2</sub>	M <sub>1</sub>	P <sub>3</sub>	M <sub>2</sub>	M <sub>3</sub>	M <sub>4</sub>	P <sub>4</sub>	M <sub>5</sub>	M <sub>6</sub>						
	P <sub>1</sub>	P <sub>2</sub>	1	P <sub>3</sub>	0	1	1	P <sub>4</sub>	1	1						
	1	0	1	0	0	1	1	0	1	1						
	0	1	1	1	0	1	1	1	1	1						

For even parity

$$P_1 \rightarrow 1, 3, 5, 7, 9, 11, 13, 15 \rightarrow P_1 \text{ 10110} \rightarrow 110110$$

$$P_2 \rightarrow 2, 3, 6, 7, 10, 11, 14, 15 \rightarrow P_2 \text{ 11110} \rightarrow 011110$$

$$P_3 \rightarrow 4, 5, 6, 7, 12, 13, 14, 15 \rightarrow P_3 \text{ 01100} \rightarrow 001100$$

$$P_4 \rightarrow 8, 9, 10, 11, 12, 13, 14, 15 \rightarrow P_4 \text{ 11000} \rightarrow 011000$$

For odd parity

$$P_1 \rightarrow 1, 3, 5, 7, 9, 11, 13, 15 \rightarrow P_1 \text{ 10110} \rightarrow 010110$$

$$P_2 \rightarrow 2, 3, 6, 7, 10, 11, 14, 15 \rightarrow P_2 \text{ 11110} \rightarrow 111110$$

$$P_3 \rightarrow 4, 5, 6, 7, 12, 13, 14, 15 \rightarrow P_3 \text{ 01100} \rightarrow 101100$$

$$P_4 \rightarrow 8, 9, 10, 11, 12, 13, 14, 15 \rightarrow P_4 \text{ 11000} \rightarrow 111000$$

To get the parity bits, you can also use the BCD. i.e.

	P <sub>4</sub>	P <sub>3</sub>	P <sub>2</sub>	P <sub>1</sub>
0	0	0	0	0
1	0	0	0	1
2	0	0	1	0
3	0	0	1	1
4	0	1	0	0
5	0	1	0	1
6	0	1	1	0
7	0	1	1	1
8	1	0	0	0

	9	1	0	0	1
	10	1	0	1	0
	11	1	0	1	1
	12	1	1	0	0
	13	1	1	0	1
	14	1	1	1	0
	15	1	1	1	1

### **Question 6**

Find the CRC for the data polynomial  $x^3 + x^2 + x + 1$  where generator polynomial is  $x^3 + 1$ .

### **Solution**

At the sender side.

Given  $M(x) = X^3 + X^2 + 1$

And  $G(x)$  is  $X^3 + 1$

Then we have

$$M(x) = 1.X^3 + 1.X^2 + 1.X^1 + 1.X^0$$

i.e.    1      1      1      1

$$G(x) = 1.X^3 + 0.X^2 + 0.X + 1.X^0$$

i.e.    = 1      0      0      1

therefore,

		111	
	┌	1111000	
	│	<u>1001</u>	
1001	│	01100	
	│	<u>1001</u>	
	│	1010	
	│	<u>1001</u>	
	│	00110	
	└		

Reminder = 110

At the receiver side.

		111	
	┌	1111110	
	│	<u>1001</u>	
1001	│	1101	
	│	<u>1001</u>	
	│	1001	
	│	<u>1001</u>	
	│	0000	
	└		

Reminder = 000 Accept the information

### **Question 7**



How does the sliding window protocol increase the utilization of bandwidth?

**Solution**

Sliding window protocol increase the utilization of bandwidth by giving the receiver the allowance to allocates buffer space for n frames in advance and allows transmission of multiple frames.

**Question 8**

Define ARQ. How does ARQ facilitate the error control process?

**Solution**

Automatic repeat request, also known as automatic repeat query, is an error-control method for data transmission that uses acknowledgements and timeouts to achieve reliable data transmission over an unreliable communication channel.

ARQ facilitate the error control process by making sure packets are re-transmitted if acknowledgement is not received within a specified time and re-transmissions are repeated in a stipulated number of times

## UNIT 2 RETRANSMISSION STRATEGIES

### CONTENTS

- 1.0 Introduction
- 2.0 Objectives
- 3.0 Main Content
  - 3.1 Stop & Wait ARQ
  - 3.2 Go-Back-N ARQ
  - 3.3 Selective Repeat ARQ
  - 3.4 Pipelining
  - 3.5 Piggybacking
- 4.0 Conclusion
- 5.0 Summary
- 6.0 Tutor-Marked Assignment
- 7.0 References/Further Readings



### 1.0 INTRODUCTION

In the previous unit we discovered that, Data Link Layer is responsible for ensuring that data is received at the receiver's end in line and error free. For the same task it has two important functions to perform that is Flow control and Error control. Flow and Error control are performed by the data link protocol. Before starting discussion on methods for flow and error control, firstly, we will define Flow control and Error control.

Flow control deals with when the sender should send the next frame and for how long the sender should wait for an acknowledgement. Data link protocol takes care of the amount of data that a sender can send and that a receiver can process as, the receiver has its own limitation in terms of speed for processing the frames. It also sees the compatibility of speed of both the sender and the receiver.

Error control deals with error detection and correction method that we have already discussed in the previous unit. If, an error is found in the frame either due to **loss** of frame or due to damage of frame, retransmission of the same is required by the sender. Retransmission is required when a sender does not receive a positive acknowledgement in time, due to a loss of frame or loss of acknowledgement or if, the sender receives negative acknowledgment from the receiver due to frame not been error free. This process of retransmission is called ARQ (Automatic Repeat Request). The set of rules that will determine the operations for the sender and the receiver are named the ARQ protocol. This ARQ protocol makes the network reliable, and that is, one of the important requirements of a network system if, data transmits from one node to another over the network and ensures that data received at receiver's site is complete and accurate. Here, we will refer to ACK, for positive acknowledgement (that is receiver has correct data) and NAK (REJECT) to refer to negative acknowledgement (that is frame is received with some error). In this unit, you will study three commonly used methods for flow and error control that is Stop & Wait ARQ, GoBack-n ARQ and Selective Repeat ARQ.



## 2.0 OBJECTIVES

After going through this unit, you should be able to:

1. define flow and error control
2. define IS ARQ
3. define functionality of data link protocol
4. define Stop & Wait ARQ method for error and flow control
5. define GoBack-n ARQ method for error and flow control
6. perform selective Repeat ARQ method for error and flow control
7. define pipelining.



## 3.0 MAIN CONTENT

### 3.1 Stop & Wait ARQ

This is the simplest method for flow and error control. This protocol is based on the concept that, the sender will send a frame and wait for its acknowledgment. Until it receives an acknowledgment, the sender cannot send the next frame to the receiver. During transmission of frame over the network an error can appear.

Error can be due to a frame getting damaged/lost during transmission.

Then, the receiver discards that frame by using error detection method. The sender will wait for acknowledgement of frame sent for a predetermined time (allotted time). If timeout occurs in the system then, the same frame is required to be retransmitted. Hence, the sender should maintain a duplicate copy of the last frame sent, as, in future it can be required for retransmission. This will facilitate the sender in retransmitting the lost/damaged frame.

At times the receiver receives the frame correctly, in time and sends the acknowledgment also, but the acknowledgment gets lost/damaged during transmission. For the sender it indicates time out and the demand for retransmission of the same frame appears in the network. If, the sender sends the last frame again, at the receiver's site, the frame would be duplicated. To overcome this problem it, follows a number mechanism and discards the duplicate frame.

Another situation when an error can appear in the network system is when the receiver receives the frame out of order, then it simply discards that frame and sends no acknowledgement. If, the acknowledgement is not received by the sender in time then, it assumes that the frame is lost during transmission, and retransmits it.

For distinguishing both data frame and acknowledgement frame, a number mechanism is used. For example, A data frame 0 is acknowledged by acknowledgement frame 1, to show that the receiver has received data frame 0 and is expecting data frame 1 from the sender.

Both the sender and the receiver both maintain control variable with volume 0 or 1 to get the status of recently sent or received. The sender maintains variable S that can hold 0 or 1 depending on recently sent frame 0 or 1. Similarly the receiver maintains variable R that holds 0 or 1 depending on the next frame expected 0 or 1.

Here, we are considering one directional information flow (Frame) and other direction control information (ACK) flow. If transmission of frames leads to an error then, the recovery process of the same demands, a retransmission strategy to be used that leads to four different possible outcomes, that are:

1. Normal Operation
2. When ACK is lost
3. When frame is lost
4. When ACK time out occurs

### 3.1.1 Normal Operation

If the sender is sending frame 0, then it will wait for ack 1 which will be transmitted by the receiver with the expectation of the next frame numbered frame1. As it receives ACK1 in time (allotted time) it will send frame 1. This process will be continuous till complete data transmission takes place. This will be successful transmission if ack for all frames sent is received in time. It is shown with the help of [Figure 2.20](#).

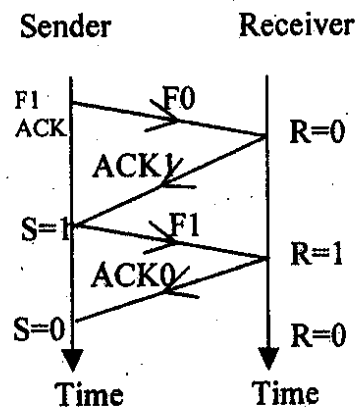

Figure 2.20: Stop and wait protocol

### 3.1.1 When ACK is lost

Here the sender will receive corrupted ACK1 for frame sent frame 0. It will simply discard corrupted ACK 1 and as the time expires for this ACK it will retransmit frame 0. The receiver has already received frame 0 and is expecting frame 1, hence, it will discard duplicate copy of frame 0. In this way the numbering mechanism solves the problem of duplicate copy of frames. Finally, the receiver has only one correct copy of one frame. This is explained with the help of [Figure 2.21](#).

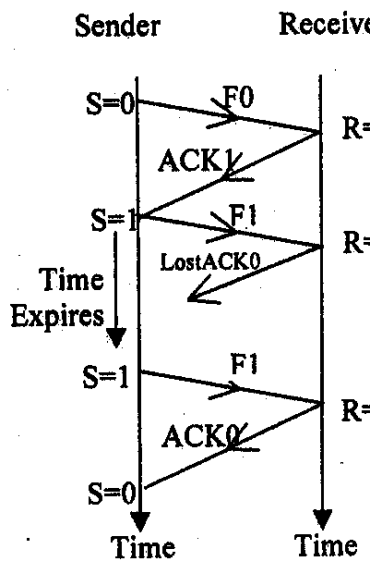

Figure 2.21: Loss of ACK

### 3.1.3 When Frame is lost

If the receiver receives corrupted/damaged frame1, it will simply discard it and assumes that the frame was lost on the way. And correspondingly, the sender will not get ACK0 as frame has not been received by the receiver. The sender will be in waiting stage for ACK0 till its time out occurs in the system. As soon as time out occurs in the system, the sender will retransmit the same frame i.e frame 1 (F1) and the receiver will send ACK0 in reply as shown in Figure 2.22.

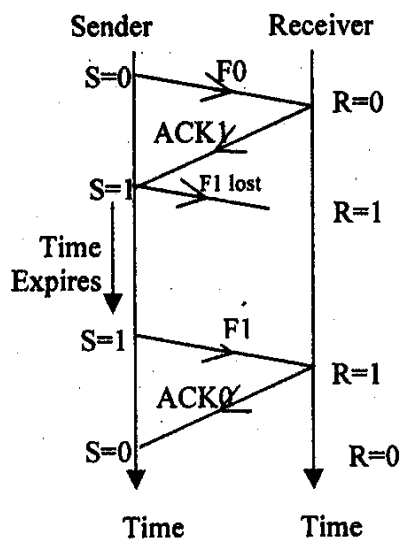
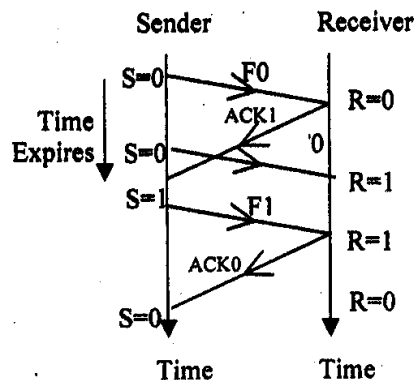

Figure 2.22: Loss of a frame

### 3.1.4 When ACK time out occurs

In this operation, the receiver is not able to send ACK1 for received frame0 in time, due to some problem at the receiver's end or network communication. The sender retransmits frame0 as ACK1 is not received in time. Then, the sender retransmits frame0 as ACK1 time expires. At the receiver end, the receiver discards this frame0

as the duplicate copy is expecting frame1 but sends the ACK1 once again corresponding to the copy received for frame0. At the sender's site, the duplicate copy of ACK1 is discarded as the sender has received ACK1 earlier as explained with the help of [Figure 2.23](#).



**Figure 2. 23: ACK lime out**

These operations indicate the importance of the numbering mechanism while, transmitting frames over the network. The method [in section 3.1](#) discussed, has low efficiency due to improper use of the communication channel. So, now, we will discuss the case, if flow of data is bidirectional. In Bidirectional transmission both the sender and the receiver can send frames as well as acknowledgement. Hence, both will maintain S and R variables. To have an efficient use of bandwidth the ACK can be appended with the data frame during transmission. The process of combining ACK with data is known as Piggybacking. The concept of piggybacking is explained in a later section. This reduces transmission overhead and increases the overall efficiency of data transmission.

The process is shown in [Figure 2.24](#)

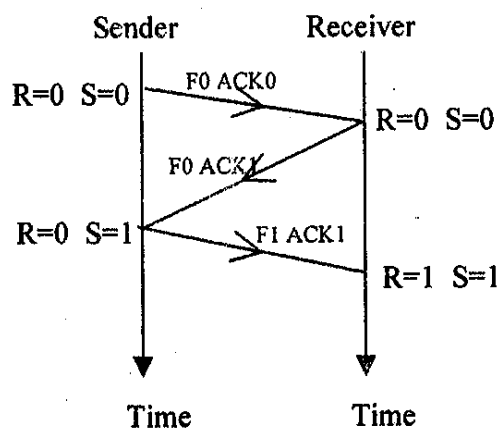

**Figure 2. 24: Piggybacking 1**

The problem with stop and wait is that only one frame can be transmitted at a time and this leads to inefficiency of transmission. To deal with this, we have another error and flow control method that we will discuss in the next section.

### 3.2 Go-Back-N ARQ

In this section, we will try to overcome the inefficient transmission that occurs in Stop & Wait ARQ. In this method, many frames can be transmitted during the process without waiting for acknowledgement. In this, we can send n frames without making the sender wait for acknowledgements. At the same time, the sender will maintain a copy of each sent frame till acknowledgement reaches it safely. As seen earlier in the Stop & Wait ARQ where, we used number mechanism, here also, we will use number method for transmission and receipt of frames. Each frame will have k bit sequence number that will be added with the frame. If, the frame can have k bit sequence number then the numbers will range between 0 to  $2^k-1$ . For example, if k is 2bit then numbers will be 0,1,2,3,0,1,2,3,0,

The sender can send 4 frames continuously without waiting for acknowledgment. But the receiver will look forward to only one frame that must be in order. If, the frame received is not in order, it will simply keep on discarding the frame till, it receives the desired sequence number frame. The receiver is not bound to send an individual acknowledgment for all frames received; it can send a cumulative acknowledgment also. The receiver will send a positive acknowledgment if, the received frame is the desired sequence number frame. Otherwise, it will keep on waiting if, the frame received is corrupted or out of order. As soon as the timer expires for the frame sent by the sender, the sender will GoBack and retransmit all frames including the frame for which the timer expired, till, the last sent frame. Hence, it is named as Go-Back-N ARQ. The process of retransmission for an error frame is shown in Figure 2.25. Go-Back- N is used in HDLC protocol.

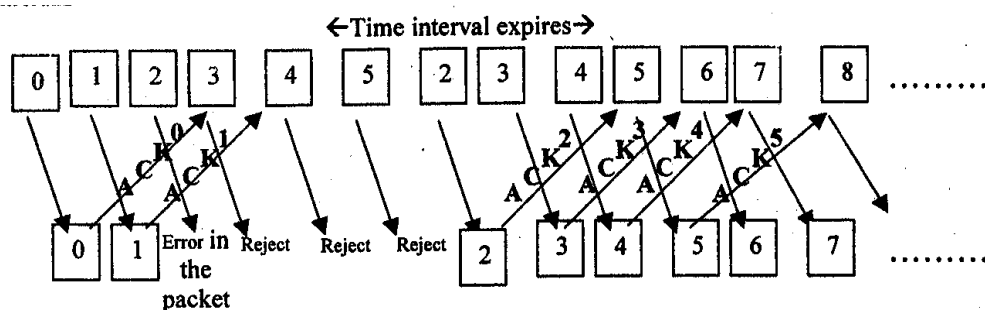

Figure 2. 25: Go-Back-N

If, the error rate is high, then, this leads to a lot of wastage of bandwidth as the sender will retransmit all the frames from, the frame in which error appears till the last sent. To increase the efficiency of transmission, when the error rate is high, another protocol called Selective Repeat ARQ is used which is discussed in the next section.

### 3.3 Selective Repeat ARQ

This method increases the efficiency of the use of bandwidth. In this method, the receiver has a window with the buffer that can hold multiple frames sent by the sender. The sender will retransmit only that frame which has some error and not all the frames as in Go-Back-N ARQ. Hence, it is named as selective repeat ARQ. Here, the size of the sender and the receiver window will be same. The receiver will not

look forward only to one frame as in Go-Back-N ARQ but it will look forward to a continuous range of frames. The receiver also sends NAK for the frame which had the error and required to be retransmitted by the sender before the time out event fires. As in the earlier section we discussed, each frame will have a sequence number that will be added with the frame. If, the frame can have  $k$  bit sequence number then the sequence number of frames will range between 0 to  $2^k-1$ . For example, if  $k$  is 2 bit then numbers will be 0,1,2,3,0,1,2,3,0. Size of sender and receiver window would be  $2^k/2$  i.e.  $4/2=2$  or it can be written as  $2^{k-1}$ . If the window size is 2 and acknowledgement for frame0 and frame1 both gets lost during transmission then, after timer expires the sender will retransmit frame0 though the receiver is expecting frame2 after frame1 was received without any error. Hence, frame0 will be discarded by the receiver as a duplicate frame. If the receiver window size is more than two, the receiver will accept duplicate frame0 as a new frame and hence, the size of window should be  $2^k/2$ . The process is shown in Figure 2.26.

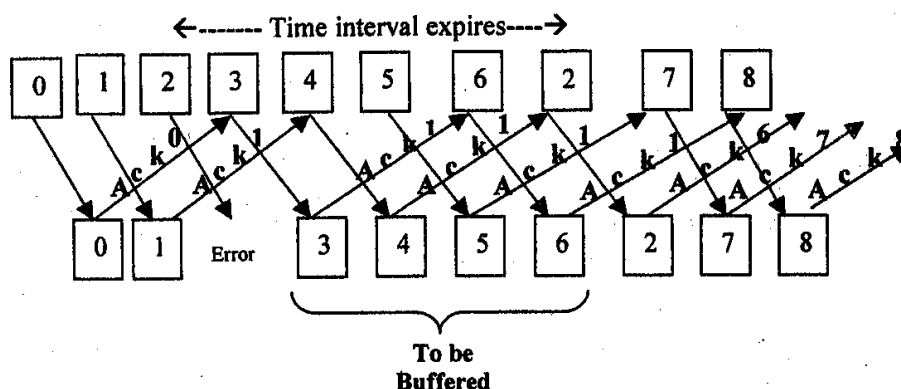

Figure 2.26: Selective Repeat

TCP uses Selective repeat ARQ strategy to deal with flow and error control. If, we consider bidirectional transmission i.e., data and acknowledgement flow from both sender and receiver then, the concept of Piggybacking can be used in a similar fashion as already discussed in Stop & Wait ARQ method, in order to better utilize bandwidth.

### 3.4 Pipelining

Pipelining in the network is one task that starts before the previous one is completed. We might also say that the number of tasks is buffered in line, to be processed and this is called pipelining. For example, while printing, through the printer before one task printing is over we can give commands for printing second task. Stop & Wait ARQ does not use pipelining. As in Stop & Wait ARQ the sender cannot send the next frames till it receives acknowledgement for the frame sent. Here, Pipelining is used in Go-Back-N ARQ and Selective repeat ARQ as both methods can send multiple frames without holding the sender for receiving the acknowledgement for frame sent earlier. This process of pipe lining improves the efficiency of bandwidth utilisation. Now, we will explain with the help of Figure 2.27 how pipelining is used in Go- Back-N ARQ.



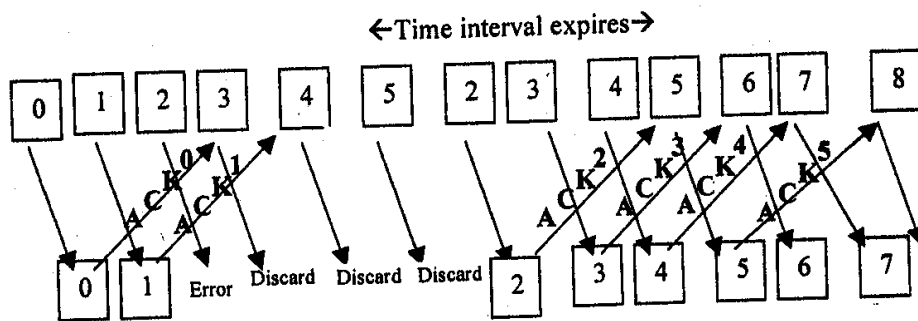

Figure 2.27: Pipelining in Go-Bank-N

Here, frame 0 is received by the receiver and without waiting for acknowledgment of frame 0 sent at sender site, the sender is allowed to send frame 1. This process is known as pipelining.

Similarly, selective repeat pipelining is used as shown in Figure 2.28 below.

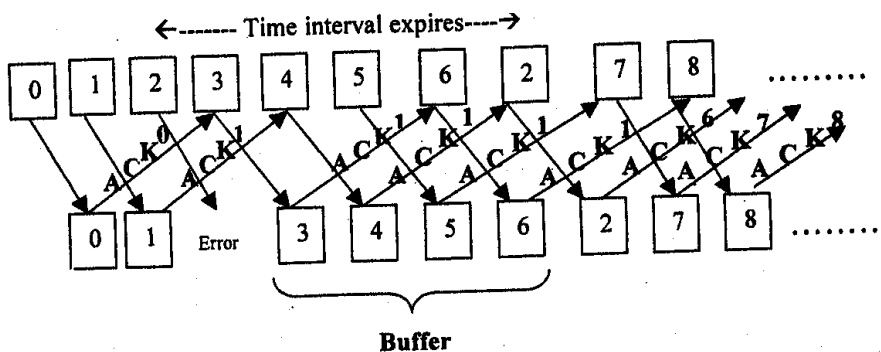

Figure 2.28: Pipelining in selective repeat

In this example we can show how pipelining increases the overall utilisation of bandwidth. Frame 0 and frame 1 are sent in continuous order without making the sender wait for acknowledgment for frame 0 first.

### 3.5 Piggybacking

Piggybacking is the process which appends acknowledgement of frame with the data frame. Piggybacking process can be used if Sender and Receiver both have some data to transmit. This will increase the overall efficiency of transmission. While data is to be transmitted by both sender and receiver, both will maintain control variable S and R. We will explain the process of piggybacking when the sender and the receiver both are transmitting data with the help of Figure 2.29.

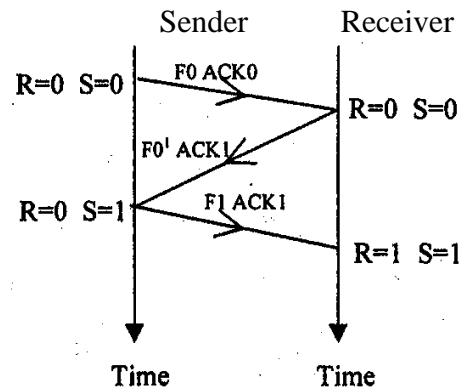

Figure 2.29: Piggybacking

Here, both the sender and the receiver maintain control variables S and R. The sender sends frame 0 (F0) with ACK0 appended along with it. Similarly, the receiver sends Frame 0(F0) with ACK1 appended to it. This way transmitting both frame and acknowledgement will concurrently increase optimal efficiency of bandwidth utilisation because piggybacking will get a free side.



#### 4.0 CONCLUSION

In this unit you have learnt about various protocols for retransmission in cases where errors occur during transmission like stop and wait ARQ method, Gob Back – ARQ, Selective repeat ARQ and pipelining.



#### 5.0 SUMMARY

This unit focuses on one prime function of the Data link layer, that is, flow and error control for achieving the goal of reliable data transmission over the network. For flow and error control retransmission strategies are considered. Flow control specifically talks about the speed of sending the frame by the sender and processing the received frame by the receiver. The speed for the sender and the receiver must be compatible. So, that all frames can be received in order and processed in time. Error control technique combines two processes error detection and error correction in the data frame. In Stop & wait ARQ protocol sender waits for acknowledgment for the last frame sent. After the acknowledgment is received by the sender then only the next frame can be sent. In Go-Back-N ARQ frames can be sent continuously without waiting for the sender to send the acknowledgement. If an error is found in any frame then frames received after that will be discarded by the receiver. Retransmission of frames will start from the error frame itself. In selective repeat Process frames can be sent continuously. But here, the receiver has a buffer window that can hold the frames received after the error frame. Hence, retransmission will be only for error frame. This increases the efficiency of data transmission on a network. For better utilisation of bandwidth, piggybacking can be used. Piggybacking process appends acknowledgement along with the data frame, this will be efficient for bidirectional communication.



## 6.0 TUTOR MARKED ASSIGNMENT 6

1. Define flow and error control.
2. Explain **why** Go-Back-N ARQ and Selective repeat ARQ are better methods for retransmission.
3. Give an example where pipelining can be applied.
4. What is the significance of control variables S and R?



## 7.0 REFERENCES/FURTHER READINGS

Andrew S. Tanenbaum, *Computer Networks*. 4<sup>th</sup> Edition, Prentice Hall of India, New Delhi, 2011.

William Stalling, *Data and Computer Communications*. 5<sup>th</sup> Edition, Prentice Hall of India, New Delhi, 2003

Behrouz A. Forouzan, *Data Communications and Networking*. 3<sup>rd</sup> Edition, Tata McGraw Hill, New Delhi, 2016

Leon Garcia and Widjaja, *Communication Network, Fundamental Concepts and Key Architectures*. 3<sup>rd</sup> Edition, Tata McGraw Hill, New Delhi.

## 8.0 ANSWERS TO TUTOR MARKED ASSIGNMENT 6

### Question 1

Define flow and error control.

### Solution

Flow control is the method of administration of data flow between two devices in such a way that the sender does not overwhelm the receiver. While error control is the method of detecting and correcting block of data during transmission.

### Question 2

Explain Go-Back-N ARQ and Selective repeat ARQ are better methods for retransmission.

### Solution

Go-Back-N ARQ resends all frames that are received after the corrupted or lost frame (i.e. if a frame is found corrupted or lost all the frames are resent) and wasted a lot of bandwidth though message could be sent without waiting for acknowledgement. While Selective repeat ARQ resends only the frame that is corrupted or lost and save bandwidth, hence improved on Go-Back-N ARQ.

### **Question 3**

Give an example where pipelining can be applied.

### **Solution**

An example of where pipelining can be applied is the manufacturing of cars i.e. a robotic arm manufactures a section of a car and pass it on the next section of the production.

### **Question 4**

What is the significance of control variables S and R?

The S and R variables refer to Sender and receiver variables. The significance is that the two of them can send and acknowledge variables in a bidirectional transmission.

## UNIT 3      CONTENTION-BASED MEDIA ACCESS PROTOCOLS

### CONTENTS

- 1.0 Introduction
- 2.0 Objectives
- 3.0 Main Content
  - 3.1 Advantages of Multiple Access Sharing of Channel Resources
    - 3.2 Pure ALOHA
    - 3.3 Slotted ALOHA
    - 3.4 Carrier Sense Multiple Access (CSMA)
    - 3.5 CSMA with Collision Detection (CSMA/CD)
    - 3.6 Ethernet Frame Format (IEEE 802.3)
- 4.0 Conclusion
- 5.0 Summary
- 6.0 Tutor-Marked Assignment
- 7.0 References/Further Readings



### 1.0 INTRODUCTION

As discussed in first unit of this module the Data Link Layer (DLL) is divided into two sub layers i.e., the Media Access Control (MAC) layer and the Logical Link Control (LLC) layer. In a network node are connected to or use a common transmission media. Based on the connection of nodes, a network can be divided into two categories, that is, point-to-point link and broadcast link. In this unit, we will discuss, broadcast link and their protocols. If, we talk about broadcast network then, a control process for solving the problem of accessing a multi access channel is required. Many protocols are available for solving the problem of multi-access channel. These protocols can control an access on shared link as in broadcast network. It is an important issue to be taken into consideration that is, how to, who gets access to the channel while, many nodes are in competition as shown in [Figure 2.30](#).

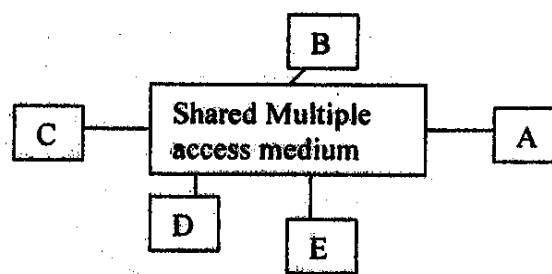

[Figure 2. 30: Shared media](#)

The protocol which decides who will get access to the channel and who will go next on the channel belongs to MAC sub-layer of DLL. Channel allocation is categorized into two, based on the allocation of broadcast among **competing** users that is Static channel allocation problem and Dynamic Channel allocation problem as shown in [Figure 2.31](#). In this unit, we will also discuss whether some access conflict or collision comes in the network, and how to deal with these conflicts. This is an important issue for LAN.

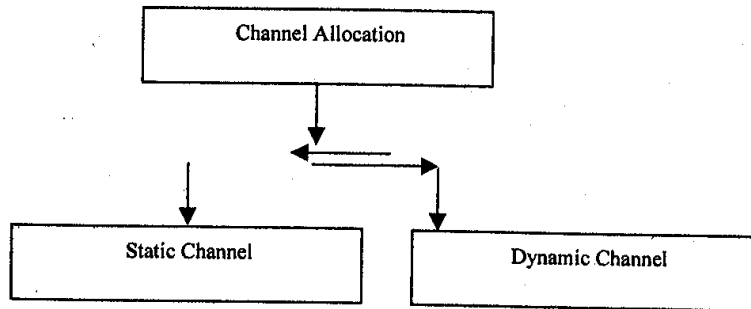

Figure 2. 31: Channel allocation technique

Here the transmission of frames can occupy the medium or any arbitrary time or in slotted time intervals (time is divided into slots). When the transmission station senses whether the channel is busy or free, this is called carrier sensing.



## 2.0 OBJECTIVES

After going through this unit, you should be able to learn:

1. the need for accessing multi-access channel
2. common methods for accessing multi-access channel like FDM, TDM
3. the need for Dynamic channel allocation method
4. pure ALOHA method for channel allocation
5. slotted ALOHA method for channel allocation
6. carrier sensing method CSMA to improve performance
7. carrier sensing with collision detection method CSMA/CD
8. IEEE 802.3 standard and their Different Cabling types
9. basics of Giga Bit Ethernet.



## 3.0 MAIN CONTENT

### 3.1 Advantages of Multiple Access Sharing of Channel Resources

MAC sub layer's primary function is to manage the allocation of one broadcast channel among N competing users. For the same, many methods are available such as static, and dynamic allocation method.

In the static channel allocation method, allocating a single channel among N competing users can be either FDM (Frequency division multiplexing) or TDM (Time division multiplexing). In FDM the total bandwidth will be divided into N equal parts for N users. This way, every user will have their own frequency band so no conflict or collision will occur among user in the network. But this is feasible only when the number of users are small and traffic is also limited. If, the number of users becomes large this system has faced many problems like either one user is gets one frequency band that is not used at all or the other user does not get a frequency band for transmission. Hence, it is simple and efficient for a small number of users.

Similarly, in TDM (Time Division Multiplexing), discussed with first Block every user will get a fixed **number of time** slot.

In the dynamic channel allocation, the important issues to be considered are whether, time is continuous or discrete or whether the station is carrier sensing large number of stations each with small and busy traffic.

Many methods are available for multiple access channel like ALOHA, CSMA etc. that we will discuss in the following section.

### 3.2 Pure ALOHA

As we have discussed earlier in the previous unit, if, one node sends a frame to another node, there can be some error in the frame. For the same we discussed some retransmission strategies to deal with the error. But, in case of allocating a single channel among N uncoordinated competing users, then the probability of collision will be high. Station accesses the channel and when their frames are ready. This is called random access. In an ALOHA network **Figure 2.32**, one station will work as the central controller and the other station will be connected to the central station. If, any of stations want to transmit data among themselves, then, the station sends the data first to the central station, which broadcast it to all the stations.

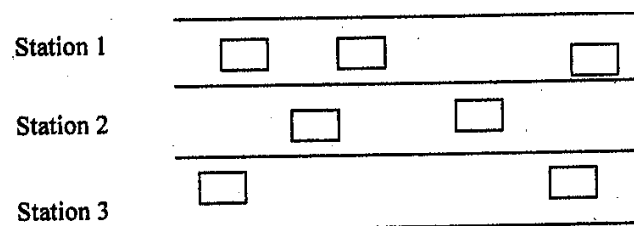

**Figure 3: ALOHA**

**Figure 2.32: ALOHA**

Here, the medium is shared between the stations. So, if two stations transmit a frame at overlapping time then, collision will occur in the system. Here, no station is constrained, any station that has data /frame to transmit can transmit at any time. Once one station sends a frame (when it receives its own frame and assumes that the destination has received it) after 2 times the maximum propagation time. If the sender station does not receive the its own frame during this time limit then, it retransmit this frame by using back off algorithm that we will discuss later on. And if, after a number of repeats if it does receive own packet then the station gives up and stops retransmitting the same frame.

Let R be the bit rate of the transmission channel and L be the length of the frame. Here, we are assuming that the size of frame will be constant and hence, it will take constant time  $t = L/R$  for transmission of each packet.

As in the case of Pure ALOHA (**Figure 2.32**) protocol frames can be sent any time so, the probability of collision will be very high. Hence, to present a frame from colliding, no other frame should be sent within its transmission time. We will explain this with the help of the concept of vulnerable period as shown in **Figure 2.33**. Let

“a” be a frame that is transmitted at time  $t_0$  and  $t$  be the time required for its transmission. If, any other station sends a frame between  $t_0$  and  $t_0+t$  then the end of the frame will collide with that earlier sent frame. Similarly, if any other station transmits a frame between the time interval  $t_0+t$  and  $t_0+2t$  again, it will result in a garbage frame due to collision with the reference frame. Hence,  $2t$  is the vulnerable interval for the frame. In case a frame meets with collision that frame is retransmitted after a random delay.

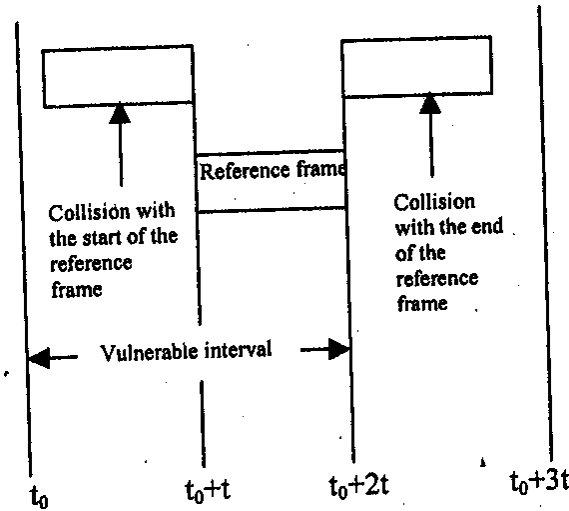

Figure 2.33: Vulnerable period

Hence, for the probability of successful transmission, no additional frame should be transmitted in the vulnerable interval  $2t$ .

To find the probability of no collision with a reference a frame, we assume that a number of users are generating new frames according to Poisons distribution. Let  $S$  be the arrival rate of new frames per frame time. As we find probability of no collision,  $S$  will represent the throughput of the system. Let  $0$  be the total arrival rate of frames including retransmission frames (also called load of the system). For finding the probability of transmission from the new and retransmitted frame. It is assumed that frames arrival is Poisson distributed with an average number of arrivals of  $G$  frames/frame time. The probability of  $k$  frames transmission in  $2t$  seconds is given by the Poisson distribution as follows:

The throughput of the system  $S$  is equal to total arrival rate  $0$  times the probability of successful transmission with no collision

$$\text{That is } S = G * P$$

$$S = G * P \text{ (zero frame transmission in the vulnerable interval i.e., } 2t \text{ seconds) since}$$

$$P [K \text{ frame in vulnerable interval } 2t) = \frac{(2G)e^{-2G}}{K!}, K = 0, 1, 2, 3$$

Thus



$P [K = 0 \text{ in } 2t] = e^{-2G}$   
 Hence,  $S = G * P = G \cdot e^{-2G}$   
 Note that the average load is  $G$ . Hence, it is  $2G$  in  $2t$   
 $S = G * e^{-2G}$

The relationship between  $S$  vs.  $G$  can be shown in **Figure 2.34**.

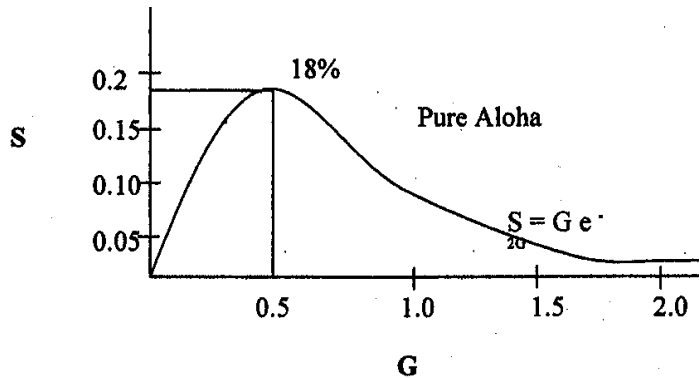

**Figure 2.34: Throughput vs. load graph of pure ALOHA**

As  $G$  is increasing,  $S$  is also increasing for small values of  $G$ . At  $G=1/2$ ,  $S$  attains its peak value i.e.,  $S=1/2e$  i.e., 0.18(approx.). After that, it starts decreasing for increasing values of  $G$ . Here, the average number of successful transmission attempts/frames can be given as  $G/S = e2G$ .

An average number of unsuccessful transmission attempts/frame is  $G/S - 1 = e^{2G} - 1$ .

By this, we know that the performance of ALOHA is not good as unsuccessful transmission are increasing exponentially with load  $G$ . So, we will discuss Slotted ALOHA in the next section to see how performance can be improved.

### 3.3 Slotted ALOHA

In this, we can improve the performance by reducing the probability of collision. In the slotted ALOHA stations are allowed to transmit frames in slots only. If more than one station transmits in the same slot, it will lead to collision. This reduces the occurrence of collision in the network system. Here, every station has to maintain the record of time slot. The process of transmission will be initiated by any station at the beginning of the time slot only. Here also, frames are assumed to be of constant length and with the same transmission time. Here the frame will collide with the reference frame only if, it arrives in the interval  $t_0-t$  to  $t_0+t$ . Hence, here the vulnerable period is reduced, that is, to  $t$  seconds long.

The throughput of the system  $S$  is equal to the total arrival rate  $G$  times the probability of successful transmission with no collision

That is  $S = G \cdot P$   
 $S = G * P$  (zero frame transmission in  $t$  seconds)

The probability of k frames transmission in t seconds is given by the Poisson distribution as follows:

$$P[k] = (G)^k e^{-G}/k! \quad k = 0,1,2,3$$

Here average load in the vulnerable interval is G (one frame time) Hence, the probability of zero frames in t seconds =  $e^{-G}$

$$S = Ge^{-G}$$

The relationship between S vs G can be shown in Figure 2.35.

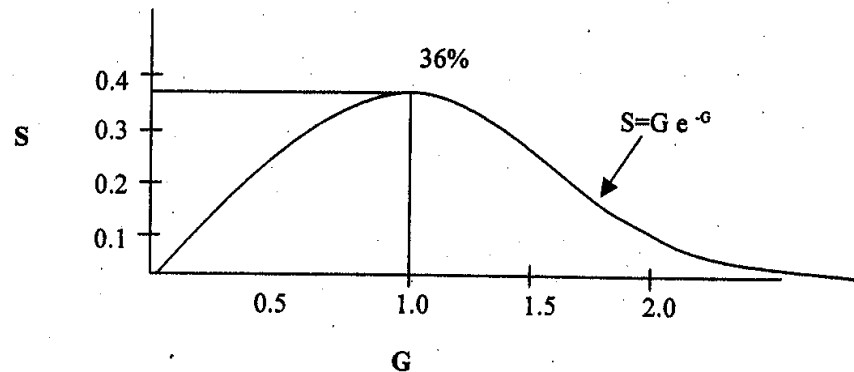

Figure 2.35: Throughput vs. load graph of slotted ALOHA

From the figure we can see that the system is exhibiting its performance, maximum throughput that can be achieved with Slotted ALOHA  $S=1/e= 36\%$  (Approx.) However, with this performance also we are not able to utilise the medium in an efficient manner. Due to the high rate of collision systems the bandwidth is which was designed to implement random access in LANs. So, we will discuss a new protocol called CSMA in the next section.

### 3.4 Carrier Sense Multiple Access (CSMA)

As we have seen in previous section, the Slotted ALOHA maximum throughput that can be achieved is *i.e.* only, though, the stations do not keep track of what the other station is doing or what's going on in the medium. Then also, many frames meet and collide. So in LANs we will observe the behaviour of other station as well and try to reduce the number of collision to achieve better throughput of the network. To achieve maximum throughput here, we will try to restrict transmission that will cause collision by sensing whether the medium has some data or not. Protocols in which station senses the channel before starting transmission are in the category of CSMA protocols (also known as listen before talk protocols).

CSMA have many variants available that are to be adapted according to the behaviour of the station that has frames to be transmitted when the channel is busy or that some transmission is going on. The following are some versions of CSMA protocols:

1. 1-Persistent CSMA
2. Non-Persistent CSMA
3. p-Persistent CSMA

### 3.4.1 1-Persistent CSMA

In this protocol a station i.e., who wants to transmit some frame will sense the channel first, if it is found busy than that some transmission is going on the medium, then, this station will continuously keep sensing that the channel. And as soon as this station finds that the channel has become idle it will transmit its frame. But if more than one station is in waiting state and keeps track of the channel then a collision will occur in the system because both waiting station will transmit their frames at the same time. The other possibility of collision can be if the frame has not reached any other station then, it indicates to the second station that the channel is free. So, the second station also starts its transmission and that will lead to collision. Thus, I-persistent CSMA a greedy protocol as to capture the channel as soon as it finds it idle. And, hence, it has a high frequency of collision in the system. In case of collision, the station senses the channel again after random delay.

### 3.4.2 Non-Persistent CSMA

To reduce the frequency of the occurrence of collision in the system then, another version of CSMA, that is, non-persistent CSMA can be used. Here, the station who has frames to transmit first sense whether the channel is busy or free. If the station finds that channel to be free it simply transmits its frame. Otherwise, it will wait for a random amount of time and repeat the process after that time span is over. As it does not continuously senses the channel to be, it is less greedy in comparison of I-Persistent CSMA. It reduces the probability of the occurrence of collision as the waiting stations will not transmit their frames at the same time because the stations are waiting for a random amount of time, before restarting the process. Random time may be different for different stations so, the likelihood waiting station will start their transmission at the same time is reduced. But, it can lead to longer delays than the 1-Persistent CSMA.

### 3.4.3 p-Persistent CSMA

This category of CSMA combines features of the above versions of CSMA that is 1-persistent CSMA and non-persistent CSMA. This version is applicable for the slotted channel. The station that has frames to transmit, senses the channel and if found free then simply transmits the frame with  $p$  probability and with probability  $1-p$  it, defers the process. If the channel is found busy then, the station persists sensing the channel until it became idle. Here value of  $p$  is the controlling parameter.

After studying the behaviour of throughput vs load for persistent CSMA it is found that Non-Persistent CSMA has maximum throughput. But we can using collision detection mechanism improve upon this to achieve more throughput in the system using collision defection mechanism and for the same we will discuss CSMA/CD in the next section.

## 3.5 CSMA with Collision Detection (CSMA/CD)

As before here also any transmission in the system needs to sense the channel to see whether it is busy or free. The stations ensure that the transmission will start only

when it finds that the channel is idle. In CSMA/CD the station aborts the process of transmission as soon as they detect some collision in the system. If two stations sense that the channel is free at the same time, then, both start transmission process immediately. And after that, both stations get information that collision has occurred in the system. Here, after the station detecting the collision, the system aborts the process of transmission. In this way, time is saved and utilisation of bandwidth is optimised. This protocol is known as CSMA/CD and, this scheme is commonly used in LANs. Now, we will discuss the basic operation of CSMA/CD. Let  $t$  be the maximum transmission time between two extreme ends of a network system (LAN). At  $t_0$  station A, at one extreme end of the LAN begins the process of transmitting a frame  $F_A$ . This frame reaches the station E which at another extreme end of the same network system in  $t$  propagation delay away. If no other station in between has started its frame transmission, it implies that A has captured the channel successfully. But, in case  $E_F$  station E starts its frame transmission just before the arrival of frame from station A frame then, collision will take place. Station A will get the signal of collision after  $2t$  time. Hence,  $2t$  time is required to ensure that station A has captured the channel successfully as shown with the help of **Figure 2.36**.

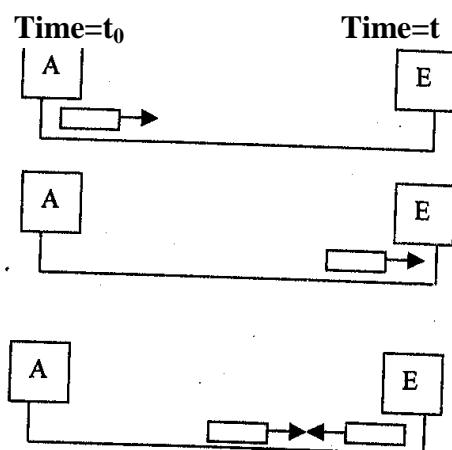

**Figure 2.36: Collision detection**

Collision of frames will be detected by looking at the strength of electric pulse or signal received after collision. After a station detects a collision, it aborts the transmission process and waits for some random amount of time and tries the transmission again with the assumption that no other station has started its transmission in the interval of propagation time. And hence, in CSMA/CD the channel can be any of the following three states as it can be shown with the **Figure 2.37**.

- Transmission of frame is going on.
- Idle slot.
- Contention period/slot.

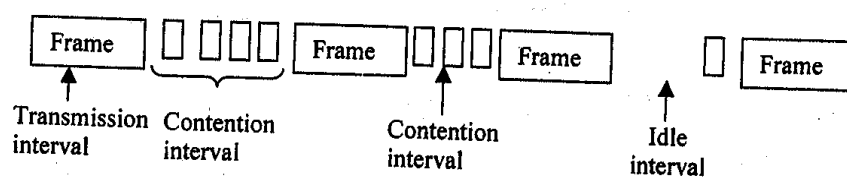

**Figure 2.37: Transmission states**

In CSMA/CD a station with a frame ready to begin transmission senses the channel and starts transmission if it finds that the channel is idle. Otherwise, if it finds it busy, the station can persist and use backoff algorithm which will be discussed in the next paragraph.

### 3.5.1 Backoff Algorithm

With the help of backoff algorithm we will see how the **randomisation** process occurs as soon as collision detection takes place. Time is divided into discrete slots with the length of worst-case propagation time (propagation time between two extreme ends of LAN)  $2t$ . After the first collision in the system, each station waits for 0 or 1 slot time before trying transmission for the next time. If, two stations that collide select the same random number then collision will be repeated. After the second collision, the station will select 0, 1, 2 or 3 randomly and wait for these many number of slots. If, the process of collision will occur repeatedly, then, the random number interval would be between 0 and  $2^i - 1$  for  $i^{\text{th}}$  collision and this number of slots will be the waiting time for the station. This algorithm is known as the binary exponential algorithm.

### 3.6 Ethernet Frame Format (IEEE 802.3)

Ethernet protocol is a MAC sublayer protocol. Ethernet stands for cable and IEEE 802.3 Ethernet protocol was designed to operate at 10 Mbps. Here, we will begin discussing the Ethernet with various types of cabling. With the help of **Figure 2.38**, we will try to summarise the cabling used for baseband 802.3 LANs.

Characteristic\Cable	10Base5	10Base2	10BaseT	10BaseF
Medium	Thick Coaxial Cable	Thin Coaxial Cable	Twisted Pair	Optical Fiber
Maximum Length of segment	500 m	200 m	100 m	2 Km
Topology	Bus	Bus	Star	Star
Advantages	Used for connecting workstation with tap on the cable	Low cost	Existing environment can use Hub and connect the stations	Good noise immunity and good to use

**Figure 2.38: Characteristics of Ethernet Cable**

IEEE 802.3 Ethernet accesses the channel using I-persistent CSMA/CD method in LAN. Now we will discuss MAC frame structure for IEEE 802.3 with the help of **Figure 2.39**.

Preamble	Start Delimiter of frame	Destination Address	Source Address	Length of Data Field	Data	Pad	Frame Check Sum
----------	--------------------------	---------------------	----------------	----------------------	------	-----	-----------------

Figure 2.39: Ethernet Frame Format

Each frame has seven fields explained as follows:

**Preamble:** The first field of 802.3 frame is 7 byte (56 bits) long with a sequence of alternate 1 and 0 Le., 10101010. This pattern helps the receiver to synchronise and get the beginning of the frame.

**Starting Delimiter (SD):** The second field start delimiter is 1 byte (8 bit) long. It has pattern 10101011. Again, it is to indicate the beginning of the frame and ensure that the next field will be a destination address. Address, here, can be a single address or a group address.

**Destination Address (DA):** This field is 6 byte (48 bit) long. It contains the physical address of the receiver.

**Source Address (SA):** This field is also 6 byte (48 bit) long. It contains the physical address of the sender.

**Length of Data Field:** It is 2 byte (16 bit) long. It indicates the number of bytes in the information field. The longest allowable value can be 1518 bytes.

**Data:** This field size will be a minimum of 46 bytes long and a maximum of 1500 bytes as will be explained later.

**Pad:** This field size can be 0 to 46 bytes long. This is required if, the data size is less than 46 bytes as a 802.3 frame must be at least 64 bytes long.

**Frame Checksum (FCS):** This field is 4 bytes (32 bit) long. It contains information about error detection. Here it is CRC-32.

### Minimum and Maximum Length of Frame

Minimum frame length = 64 bytes = 512 bits

Maximum frame length= 1518 bytes = 12144 bits

Minimum length or lower limit for frame length is defined for normal operation of CSMA/CD. This is required so that, the entire frame is not transmitted completely before its first bit has been received by the receiver. If, this happens then the probability of the occurrence of collision will be high (the same has been explained earlier in the previous section CSMA/CD).

Hence, Ethernet frame must be of 64 bytes long. Some of the bytes are header and trailer parts of the frame. If, we consider 6 bytes destination address, 6 bytes source address, 2 bytes length and 4 bytes **Frame Check Sum (FCS)** ( $6+6+2+4=18$ ) then, the minimum length of data will be  $64-18= 46$  bytes. If, frame is less than 46 bytes then, padding bits fill up this difference.

As per 802.3 standard, the frames maximum length or upper limit of frame is = 1518 bytes (excluding preamble and SD). If we subtract 18 bytes of header and trailer then, the maximum length will be 1500 bytes.



#### 4.0 CONCLUSION

In this unit you have learnt about the various MAC sub-layer protocols like pure ALOHA, slotted ALOHA, CSMA and CSMA/CD. The next unit will introduce you to Wireless LAN and Data Link Layer Switching.



#### 5.0 SUMMARY

In some networks, if a single channel and many users use that channel, then, allocation strategy is required for the channel. We have discussed FDM and TDM allocation method. They are the simplest methods for allocation. They work efficiently for a small number of **users**. For a large number of users, the ALOHA protocol is considered. There are two versions of ALOHA that is Pure ALOHA and Slotted ALOHA. In Pure ALOHA no slotting was done but the efficiency was poor. In Slotted ALOHA, slots have been made, so that every frame transmission starts at the beginning of the slot and throughput is increased by a factor of 2. For avoiding collision and to increase efficiency in sensing the channel, CSMA is used. Many versions of CSMA are persistent and non-persistent. In CSMA/CD collision detection process is added so that process can be aborted just after a collision is detected. Ethernet is a commonly used protocol for LAN. IEEE 802.3 Ethernet uses 1 persistent CSMA/CD access method.



#### 6.0 TUTOR MARKED ASSIGNMENT 7

1. Why is DLL divided into two sub layers? What are the key functions of those sub layers?
2. How does Slotted ALOHA improve the performance of the system over Pure ALOHA?
3. How has non-persistent reduced the probability of collision?
4. Explain Back off Algorithm and give one example of where it is used.



#### 7.0 REFERENCES/FURTHER READINGS

Andrew S. Tanenbaum, *Computer Networks*. 4<sup>th</sup> Edition, Prentice Hall of India, New Delhi, 2011.

William Stallings, *Data and Computer Communications*. 5<sup>th</sup> Edition, Pearson Education, New Delhi, 2003.

Behrouz A. Forouzan, *Data Communications and Networking*. 3<sup>rd</sup> Edition, Tata McGraw Hill, New Delhi, 2016.

*Communication Networks- Fundamental Concepts and Key Architectures*. Leon Garcia and Widjaja 3<sup>rd</sup> Edition, Tata McGraw Hill, New Delhi.

## **8.0 ANSWERS TO TUTOR MARKED ASSIGNMENT 7**

### **Question 1**

Why is DLL divided into two sub layers? What are the key functions of those sub layers?

### **Solution**

The data link layer is divided into two sub layers (Logical Link Control (LLC) and Media Access Control (MAC)) to allow for easy interoperability of different network technologies.

LLC makes available the logics of the data link. Hence, manage the synchronization, flow control and error checking activities of data link layer

MAC made available the management and assessment of the transmission medium. It performs the function of transfer of data packets from one network interface card (NIC) to another, throughout the shared communication channel. Here, physical address and MAC address functions are handled.

### **Question 2**

How does Slotted ALOHA improve the performance of the system over Pure ALOHA?

### **Solution**

Slotted Aloha gives room for transmission of data at the beginning of time slot and reduces number of collisions to half thereby increases the efficiency to 36.8% from 18.4%.

Pure Aloha can transmit data at any time, continuous and not globally synchronized

### **Question 3**

How has non-persistent reduced the probability of collision?

### **Solution**

The non-persistent reduced the probability of collision by waiting a random number of times after sensing the line before sensing again. It is not common for two ore more



station to wait the same number of times before sensing again and retry at the same time.

#### **Question 4**

Explain Back off Algorithm and give one example of where it is used.

This is a method used in the transmission of data after collision between two stations.

If two stations transmit a frame at overlapping time then, collision will occur in the system. Here, no station is constrained, any station that has data /frame to transmit can transmit at any time. Once one station sends a frame (when it receives its own frame and assumes that the destination has received it) after 2 times the maximum propagation time. If the sender station does not receive the its own frame during this time limit then, it retransmit this frame by using back off algorithm.

An example is the random-access MAC protocol (CSMA/CD), for instance, in Ethernet to schedule re-transmissions after collisions.

## UNIT 4 WIRELESS LAN AND DATA LINK LAYER SWITCHING

### CONTENTS

- 1.0 Introduction
- 2.0 Objectives
- 3.0 Main Content
  - 3.1 Introduction to Wireless LAN
  - 3.2 Wireless LAN Architecture (IEEE 802.11)
  - 3.3 Hidden Station and Exposed Station Problems
  - 3.4 Wireless LAN Protocols: MACA and MACAW 49
  - 3.5 IEEE 802.11 Protocol Stack
    - 3.5.1 The 802.11 Physical Layer
    - 3.5.2 The 802.11 MAC Sub-layer Protocol
  - 3.6 Switching at Data Link Layer
    - 3.6.1 Operation of Bridges in Different LAN Environment
    - 3.6.2 Transparent Bridges
    - 3.6.3 Spanning Tree Bridges
    - 3.6.4 Source Routing Bridges
- 4.0 Conclusion
- 5.0 Summary
- 6.0 Tutor-Marked Assignment
- 7.0 References/Further Readings



### 1.0 INTRODUCTION

The Previous discussion, we had in this block was related to wired LANs but recently, wireless LANs are taking a dominant position due to coverage of location difficult to wire, to satisfy the requirement of mobility and ad-hoc networking. In a few years from now, we will notice a broader range of wireless devices accessing the Internet, such as digital cameras, automobiles, security systems, kitchen appliances. **KUROSE** and **ROSS** (2003) write that someday wireless devices that communicate with the Internet may be present everywhere: on walls, in our cars, in our bedrooms, in our pockets and in our bodies.

In this unit, we cover two broad topics: Wireless LAN, its protocols, its standard and Data Link Layer Switching. In organisation we need an interconnection mechanism so that all nodes can talk to each other. Bridges and switches are used for this purpose. The spanning tree algorithms are used to build plugs and act as bridges.



## 2.0 OBJECTIVES

After going through this unit, you should be able to:

1. understand what is a wireless LAN
2. describe the various LAN Protocols
3. understand the IEEE 802.11 Standard
4. describe the operation of bridges (transparent, spanning tree and remote bridges).



## 3.0 MAIN CONTENT

### 3.1 Introduction to Wireless LAN

As the number of mobile computing and communication devices grows, so does the demand to connect them to the outside world, A system of notebook computers that communicate by radio can be regarded as a wireless LAN. These LANs have different properties than conventional LANs and require special MAC sublayer protocols. The 802.11b standard defines the physical layer and media access sublayer for wireless local area network.

To understand the concept, we will take a simplistic view that, all radio transmitters have some fixed range. When a receiver is within a range of two active transmitters, the resulting signal will generally be garbled and of no use. It is important to realise that in some wireless LANs, not all stations are within the range of one another, which leads to a variety of complications, which we will discuss in the next sections.

Wireless LANs are commonly being used in academic institutions, companies, hospitals and homes to access the internet and information from the LAN server while on roaming.

### 3.2 Wireless LAN Architecture (IEEE 802.11)

The wireless LAN is based on a cellular architecture where the system is subdivided into cells as shown in **Figure 2.40**. Each cell (called basic service set or BSS, in the 802.11) is controlled by a base station (called access point or AP). Wireless LAN may be formed by a single cell, with a single access point (it can also work within an AP), most stations will be formed by several cells, where the APs are connected through some kind of backbone (called distribution system or DS). This backbone may be the Ethernet and, in some cases, it can be the wireless system. The DS appears to upper-level protocols (for example, IP) as a single 802 network, in much the same way as a bridge in wire 802.3. The Ethernet network appears as a single 802 network to upper-layer protocols.

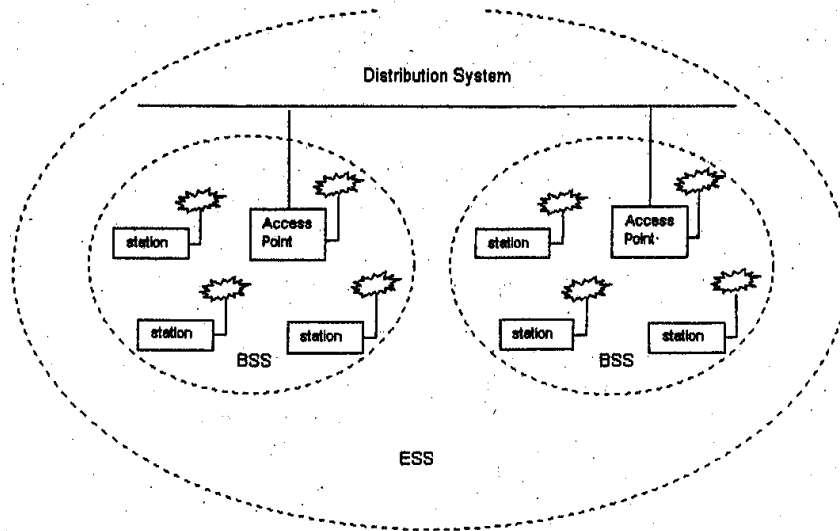

Figure 2.40: Wireless LAN architecture

Stations can also group themselves together to form an **ad-hoc** network: a network with no central control and with no connections to the “outside world.” Here, the network is formed “on the fly,” simply because, there happens to be mobile devices that have found themselves in proximity to each other, that have a need to communicate, and that find no pre-existing network infrastructure. An **ad-hoc** network might be formed when people with laptops meet together (for example, in a conference room, a train, or a car) and want to exchange data in the absence of a **centralised** AP. There has been tremendous interest in **ad-hoc** networking, as communications between devices continue to proliferate.

### 3.3 Hidden Station and Exposed Station Problems

There are two fundamental problems associated with a wireless network. Assume that there are four nodes A, B, C and D. B and C are in the radio range of each other. Similarly A and B are in the radio range of each other. But C is not in the radio range of A.

Now, suppose that there is a transmission going on between A and B (Figure 2.41 (a)). If C also wants to transmit to B, first, it will sense the medium but will not listen to A’s transmission to B because, A is outside its range. Thus, C will create garbage for the frame coming from A if, it transmits to B. This is called **the hidden station problem**. The problem of a station not being able to detect another node because that node is too far away is called hidden station problem.

Now, let us consider the reverse situation called the **exposed station problem** (Figure 2.41 (b)).

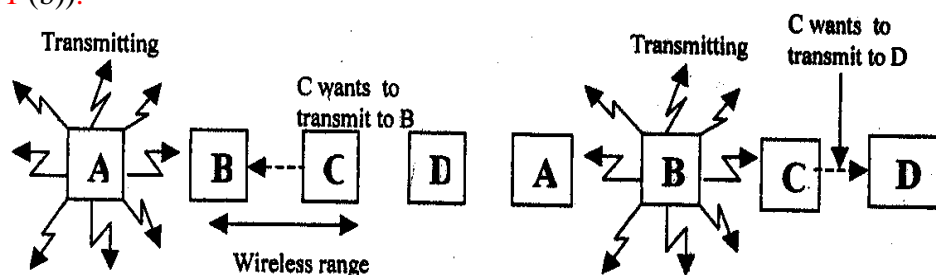

(a) Hidden Station Problem

(b) Exposed Station Problem

Figure 2.41: Hidden and exposed station problem

In this case, B is transmitting to A. Both are within radio range of each other. Now C wants to transmit to D. As usual, it senses the channel and hears an ongoing transmission and falsely concludes that it cannot transmit to D. But the fact is transmission between C and D would not have caused any problems because, the intended receivers C and D are in a different range. This is called exposed station problem.

### 3.4 WIRELESS LAN PROTOCOLS: Multiple Access with Collision Avoidance (MACA) AND Media Access protocol for Wireless LANs (MACAW)

In this section, we, will describe two wireless LAN protocols: MACA and MACAW. MACAW is the oldest protocol of the two. MACA was proposed as an alternative to CSMA Protocol which has certain drawbacks:

First, it senses the channel to see if the channel is free, it transmits a packet, otherwise it waits for a random amount of time.

Hidden Station Problems leading to frequent collision.

Exposed terminal problems leading to worse bandwidth utilization. MACA eliminates the hidden and exposed station problems using RTS (Repeat to Send) and CTS (Clear to Send) handshake mechanism, which is explained below through a Figure 2.42. RTS and CTS packets carry the expected duration of the data transmission, which will have some implications. All nodes near the sender/receiver after hearing RTS/CTS will defer the transmission. Therefore, it avoids some cases of hidden and exposed station problems. However, it does not always avoid these problems. If, the neighbour hears the RTS only, it is free to transmit once the waiting interval is over.

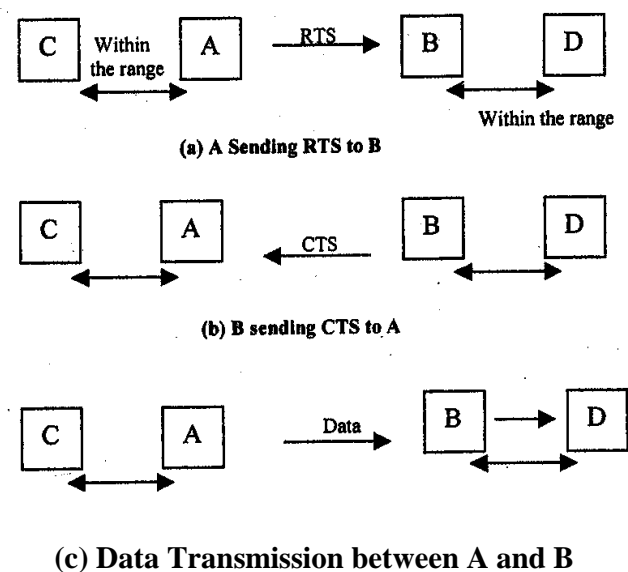

Figure 2.42: MACA Protocol

Just assume that, there are four nodes A, B, C, and D in a wireless LAN (Figure 2.42). A is a sender and B is a receiver. The station C is within range of A but not within range of B. Therefore, it can hear transmission from A (i.e., RTS) but not transmission from B (i.e., CTS) (Figure 2.42(a) and 2.42(b)). Therefore, it must remain silent long enough for the CTS to be transmitted back to A without conflict. The station D is within the range of B but not A so it hears CTS but not RTS. Therefore, it must remain silent during the upcoming data transmission, whose length it can tell by examining the CTS frame. This is illustrated through a diagram (Figure 2.42 3(a) and 2.42(c) A sends RTS to B. Then B sends CTS to A. Then, follows data between A and B.

C hears the RTS from A but not the CTS from B. As long as it does not interfere with the CTS, it is free to transmit while the data frame is being sent. In contrast, the station D is within range of B but not A. It does not hear the RTS but does hear the CTS. Hearing the CTS tips it off that, it is close to a station that is about to receive a frame, so it defers sending anything until that frame is expected to be finished.

Despite these precautions, collisions can still occur. For example, Band C could both send RTS frames to A at the same time. These frames will collide and will be lost. In the event of a collision, an unsuccessful transmitter (i.e. one that does not hear a CTS within the expected time interval) waits a random amount of time and tries again later. MACAW (MACA for wireless) extends MACA to improve its performance which will have the following handshaking mechanism. RTS-CTS-DS-Data ACK. It is also illustrated through the following diagram (Figure 2.43).

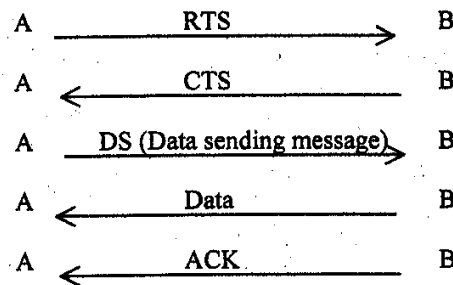

Figure 2.43: The MACAW protocol

MACA W extends MACA with the following features:

**Data link layer acknowledgement:** It was noticed that without data link layer acknowledgements, lost frames were not retransmitted until the transport layer noticed their absences, much later. They solved this problem by introducing an ACK frame after each successful data frame.

**Addition of carrier sensing:** They also observed that CSMA has some use, namely, to keep a station from transmitting a RTS while at the same time another nearby station is also doing so to the same destination, so carrier sensing was added.

**An improved backoff mechanism:** It runs the backoff algorithm separately for each data stream (source-destination pair), rather than for each station. This change improves the fairness of the protocol.

**DS (Data sending) message:** Say a neighbour of the sender overhears an RTS but not a CTS from a receiver. In this case it can tell if RTS-CTS was successful or not. When it overhears OS, it realizes that the RTS-CTS was successful and it defers its own transmission.

Finally, they added a mechanism for stations to exchange information about congestion and a way to make the back off algorithm react less violently to temporary problems, to improve system performance.

### 3.5 IEEE 802.11 Protocol Stack

IEEE 802.11 standard for wireless LAN is similar in most respects to the IEEE 802.3 Ethernet standard addresses. As shown in the **Figure 2.44** the physical layer of 802.11 corresponds to the OSI physical layer fairly well but, the data link layer in all the 802 protocols is split into two or more sub layers. In 802.11, the MAC (Medium Access Control) sub layer determines how the channel is allocated, that is, who gets to transmit next. Above it is the LLC (Logical Link Control) sublayer, whose job is to hide the differences between the different 802 variants and make them indistinguishable

as far as the network layer is concerned.

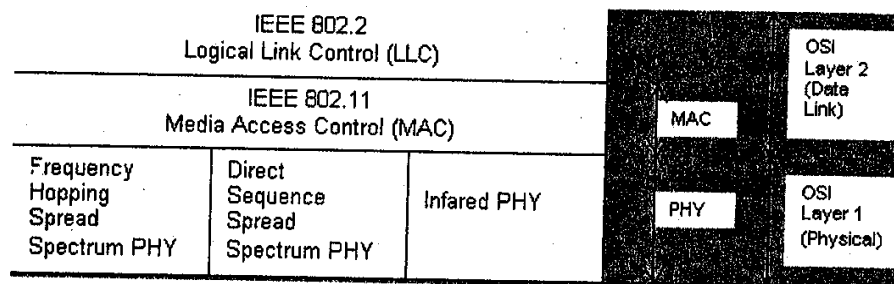

**Figure 2.44: Part of the 802.11 protocol stack**

#### 3.5.1 The 802.11 Physical Layer

The 802.11 physical layer (PHY) standard specifies three transmission techniques allowed in the physical layer. The infrared method used much the same technology as television remote controls do. The other two use short-range radio frequency (RF) using techniques known as FHSS (Frequency Hopped Spread Spectrum) and DSSS (Direct Sequence Spread Spectrum). Both these techniques, use a part of the spectrum that does not require licensing (the 2.4 -GHz **Industry, Scientific and**

**Medical**-ISM band). Radio-controlled garage door openers also use the same piece of the spectrum, so your notebook computer may find itself in competition with your garage door. Cordless telephones and microwave ovens also use this band. All of these techniques operate at 1 or 2 Mbps and at low enough power that they do not conflict too much. RF is capable of being used for 'not line of sight' and longer distances.

The other two short range radio frequency techniques are known as spread spectrum. It was initially developed for military and intelligence requirement. The essential idea is to spread information signal over a wider bandwidth to make jamming and interception more difficult. The spread spectrum is ideal for data communication because, it is less susceptible to radio noise and creates little interference. It is used to comply with the regulations for use with ISM Band.

There are two types of spread spectrum:

1. Frequency Hopping (FH), and
2. Direct Sequence (DS)

Both these techniques are used in wireless data network products as well as other communication application such as, a cordless telephone.

Under this scheme, the signal is broadcast over a seemingly random data sequence RF hopping from frequency to frequency at split second intervals. A receiver hopping between frequencies in synchronisation with the transmitter, picks up the message. Using FHSS (Frequency Hopped Spread Spectrum) the 2.4 GHz is divided into 75 MHz Channel. In this scheme, a pseudorandom number generator is used to produce the sequence of the frequencies hopped to. As long as all stations use the same seed to the pseudorandom number generator and stay synchronised in time, they will hop to the same frequencies simultaneously. FHSS' randomisation provides a fair way to allocate spectrum in the unregulated ISM band. It also provides some sort of security. Because an intruder does not know the hopping sequence it cannot eavesdrop on transmissions. Over longer distance, multipath fading can be an issue, and FHSS offers good resistance to it. It is also relatively insensitive radio interference, which makes it popular for building-to-building links. Its main disadvantage is its low bandwidth. FHSS allows for a less complex radio design than DSSS but FHSS is limited to 2 Mbps data transfer rate due to FCC regulations that restrict subchannel bandwidth to 1 MHz causing many hops which means a high amount of hopping overhead. The DSSS is a better choice for WLAN application. It is also restricted to 1 or 2 Mbps.

DSSS divides 2.4 GHz band into 14 channels. Channels using at the same location should be separated 25 MHz from each other to avoid interference. FHSS and **DSSS** are fundamentally different signalling techniques and are not capable of inter operating with each other. Under this scheme, each bit in the original signal is represented by multiple bits in the transmitted signal, which is known as chipping code. The chipping code spreads the signal across a wider frequency band in direct proportion to the number of bits used. Therefore, a 10 bit chopping code spreads signal across a frequency band that is 10 times greater than 1 bit chopping code.



### 3.5.2 The 802.11 MAC Sub-layer Protocol

After the discussion on the physical layer, it is time to switch over to the IEEE 802.11 MAC sublayer protocols which are quite different from that of the Ethernet due, to the inherent complexity of the wireless environment compared to that of a wired system. With Ethernet (IEEE 802.3) a node transmits, in case, it has sensed that the channel is free. If, it does not receive a noise burst back within the first 64 bytes, the frame has almost assuredly been delivered correctly. With wireless technology, this situation does not hold.

As discussed earlier, 802.11 does not use CSMA/CD due to the following problems:

- (i) The Hidden Station Problem: CSMA does not avoid the hidden station problem (Figure 2.45(a) & (b))

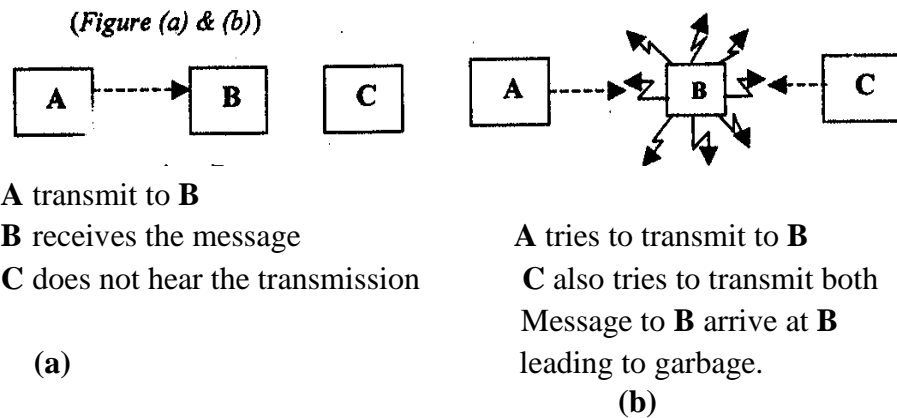
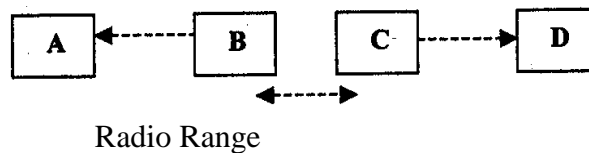

Figure 2.45: (a) The hidden station problem

- (ii) The exposed Station Problem CSMA may cause nodes to unnecessarily refrain from accessing the channel as shown in the Figure 2.45(c):



**B** Transmits to **A** which is heard by **C**  
**C** unnecessarily avoids sending a message to **D** even though there would be no collision

Figure 2.45: (c) The exposed station problem

- (iii) In addition, most radios are half duplex, meaning that they cannot transmit and listen for noise bursts at the same time on a single frequency as Ethernet does.

To deal with this problem, 802.11 I supports two modes of operation.

1. DCF (Distributed Coordination Function)
2. PCP (Point Coordinated Function) (optional)

Now, we, will examine IEEE 802.11 DCF separately. It does not use any central control. In this respect it is similar to Ethernet.

When DCF is employed, 802.11 uses a protocol called CSMA/CA (CSMA with Collision Avoidance). In this protocol, both **physical channel sensing and virtual channel sensing** are used. Two methods of operation are supported by CSMA/CA. In the first method (Physical sensing), before the transmission, it senses the channel. If the channel is sensed idle, it just wants and then transmitting. But it does not sense the channel while transmitting but, emits its entire frame, which may well be destroyed at the receiver's end due to interference there. If, the channel is busy, the sender defers transmission until it goes idle and then starts transmitting. If, a collision occurs, the colliding stations wait for a random time, using the Ethernet binary exponential back off algorithm and then try again later.

The second mode of CSMA/CA operation is based on MACAW and uses virtual channel sensing, as illustrated in **Figure 2.46**. In this example, there are four stations A, B, C, and D. A is a transmitter and B is a receiver, C is within the radio range of A (and possibly within the range of B) whereas D is within the range of B but not within range of A.

When A has to send data to B, it begins by sending an RTS frame to B to request permission to send it a frame. When B receives this request, it may decide to grant permission, in which case it sends the

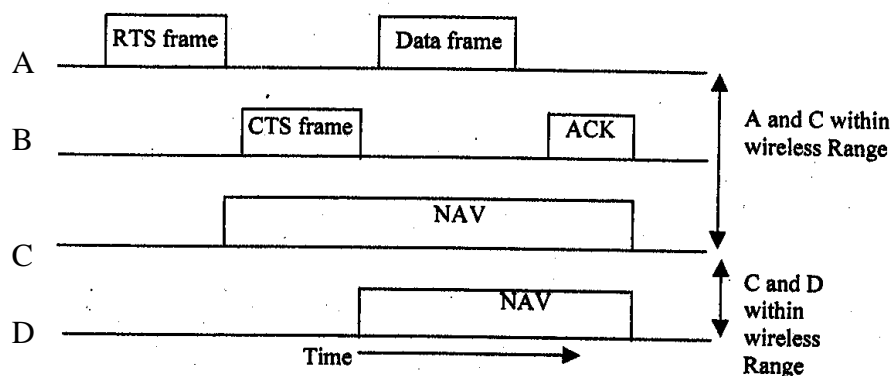

**Figure 2.46: The use of virtual channel sensing using CSMA/CA**

CTS frame back. Upon receipt of the CTS, A now sends its frame and starts an ACK timer. Upon correct receipt of the data frame, B responds with an ACK frame leading to the closure of data transfer operation between A & B. In case A's ACK timer expires before the ACK gets back to it, the whole protocol is run again.

Now, how will C and D nodes react to it? Node C is within range of A, so it may receive the RTS frame. C may receive the RTS frame because it is in the range of A. From the information in the RTS frame it estimates how long the transfer will take,

including the final ACK and asserting a kind of virtual channel busy for itself, indicated by NAV (Network Allocation Vector) as shown in Figure 2.46. Similarly, D also asserts the NAV signal for itself because it hears the CTS. The NAV signals are not for transmission. They are just internal reminders to keep quiet for a certain period of time.

In contrast to wired networks, wireless networks are noisy and unreliable. To deal with the problem of noisy channels, 802.11 allows frames to be fragmented into smaller pieces, each with its own checksum because, if a frame is too long, it has very little chance of getting through undamaged and will, probably have to be retransmitted. The fragments are individually numbered and acknowledged using a stop and wait protocol at LLC (i.e., the sender may not transmit fragment  $k+1$  until it has received the acknowledgement for fragment  $k$ ). Once the channel has been acquired using RTS and CTS, multiple fragments can be sent in a row, as shown in Figure 2.47. A sequence of fragments is called a fragment burst.

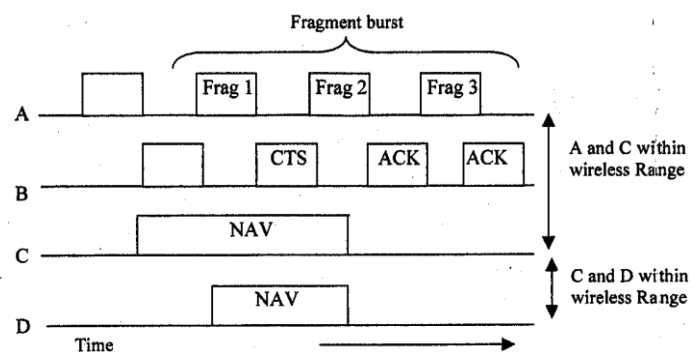

Figure 2.47: A fragment burst

The second advantage of fragmentation is that it increases the channel throughput by not allowing retransmission to the bad fragments rather than the entire frame. The size of C fragment can be adjusted by a base station in a cell. A base station in a cell can adjust the size of C fragment. The NAV mechanism keeps other stations quiet, only until the next acknowledgement, but another mechanism (described below) is used to allow a whole fragment burst to be sent without interference.

So, far we have discussed DCF in which, the base station polls the other stations, asking them if they have any frames to send. Since, transmission order is completely controlled by the base station in PCF mode, no collisions ever occurs. The standard prescribes the mechanism for polling, but not the polling frequency, polling order, or even whether all stations need to get equal service.

The basic mechanism is for the base station to broadcast a beacon frame periodically (10 to 100 times per second). The beacon frame contains system parameters, such as hopping sequences and dwell times (for FHSS), clock synchronisation, etc. It also invites new stations to sign up for polling services. Once a station has signed up for polling service at a certain rate, it is effectively guaranteed a certain fraction of the bandwidth, thus making it possible to give guarantee of quality services.

Battery life is always an issue with mobile wireless devices, so 802.11 pays attention to the issue of power management. In particular, the base station can direct a mobile station to go into sleep state until explicitly awakened by the base station or the user.

Having told a station to go to sleep, however, means that the base station has the responsibility for buffering any frames directed at it while the mobile station is asleep. These can be collected later.

PCF and DCF can coexist within one cell. At first it might seem impossible to have central control and distributed control operating at the same time, but 802.11 provides a way to achieve this goal. It works by carefully defining the interframe time interval. After a frame has been sent, a certain amount of dead time is required before any station can send a frame.

### 3.6 Switching at Data Link Layer

Before discussing data 'link layer switching devices, let us talk about repeaters which are layer I devices. Repeaters provide both physical and electrical connections. Their functions are to regenerating and propagate a signal in a channel. Repeaters are used to extend the length of the LAN which depends upon the type of medium. For example 10mbps 802.3 LAN that uses **Unshielded Twisted pair (UTP)** cable (10 BASE- T) has a maximum restriction of 100 meters. Many organisations have multiple LANs and wish to connect them. LANs can be connected by devices called bridges, which operate as the data link layer. Unlike repeaters, bridges connect networks that have different physical layers. It can also connect networks using either the same or different types of architecture at the MAC. (Token ring, **Fibre Distributed Data Interface (FDDI)**, Ethernet etc).

Bridges have some other characteristics:

1. Store and forward device.
2. Highly susceptible to broadcast storms.

Bridges are store and forward devices to provide error detection. They capture an **entire** frame before deciding whether to filter or forward the frame, which provides a high level of error detection because a frame's CRC checksum can be calculated by Tile Bridge. Bridge is highly susceptible to broadcast storms. A broadcast storm occurs when several broadcasts are transmitted at the same time. It can take up huge bandwidth.

Before looking at the technology of bridges, it is worthwhile taking a look at some common situations in which bridges are used. **Tanenbaum** [Ref. I] has six reasons **why** a single organisation may end up with multiple LANs.

#### 1. Multiple LANs in organization

Many university and corporate departments have their own LANs, primarily to connect their own personal computers, workstations, and servers. Since the goals of the various departments differ, different departments choose different LANs. But there is a need for interaction, so bridges are needed.

#### 2. Geographical difference

The organisation may be geographically spread over several buildings separated by considerable distances. It may be cheaper to have separate LANs in each building

and connect them with bridges and later link them to run a single cable over the entire site as shown in figure 2.48.

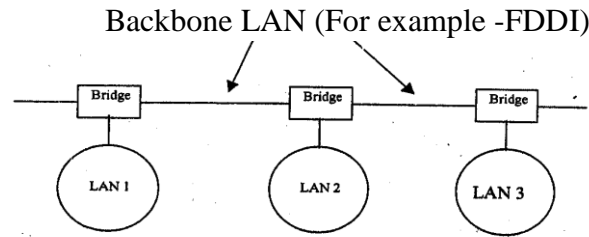

Figure 2.48: Multiple LANs connected by backbone to handle a total load higher than the capacity of single LAN

3. **Load distribution:** It may be necessary to split what is logically a single LAN into separate LANs to accommodate the load.
4. **Long Round-Trip delay:** In some situations, a single LAN would be adequate in terms of the load, but the physical distance between the most distant machines can be great (e.g. more than 2.5 km for Ethernet). Even if, laying the cable is easy to do, the network would not work due to the excessively long round-trip delay. The only solution is to partition the LAN and install bridges between the segments. Using bridges, the total physical distance covered can be increased.

#### 5. Reliability

By inserting bridges at critical points reliability can be enforced in the network by isolating II defective node. Unlike a repeater, which just copies whatever it sees, a bridge can be programmed to exercise some discretion regarding what forwards and what it does not forward.

#### 6. Security

Is a very important feature in bridges today, and can control the movement of sensitive traffic by isolating the different parts of the network.

In an ideal sense, a bridge should have the following characters:

##### a Fully transparent

It means that it should allow the movement of a machine from one cable segment to another cable segment without change of hardware and software or configuration tools.

##### b Interpretability

It should allow a machine on one LAN segment to talk to another machine on another LAN segment.

### 3.6.1 Operation of Bridges in Different LAN Environment

Having studied the features of bridges and why we require multiple LANs, let's learn how they work. Assume that, there are two machines A and B. Both of them are attached to a different LAN. Machine A is on a wireless LAN (Ethernet IEEE 802.3). While B is on both LANs are connected to each other through a bridge. Now, A has a packet to be sent to B. The flow of information at Host A is shown below:

1. The packet at machine A arrives at the LLC sublayer from the application layer through the transport layer and network layer.
2. LLC Sub layer header get attached to the packet.
3. Then it moves to the MAC Sublayer. The packet gets MAC sublayer header for attachment.
4. Since the node is part of a wireless LAN, the packet goes to the air using **Geographical Reference File-Names (GRF)**.
5. The packet is then picked up by the base station. It examines its destination address and figures that it should be forwarded to the fixed LAN (it is Ethernet in our case).
6. When the packet arrives at the bridge which connects the wireless LAN and Ethernet LAN, it starts at the physical layer of the bridge and moves to its LLC layer. At the MAC sublayer its 802.11 header is removed.
7. The packet arrives at the LLC of a bridge without any 802.11 header.
8. Since the packet has to go to 802.3 LAN, the bridge prepares packets accordingly.

**Note that a bridge connecting  $k$  different LANs will have  $K$  different MAC sublayers and  $k$  different physical layers. One for each type**

So far, we have presented a very simplistic scenario in forwarding a packet from one LAN to another through a bridge. In this section, we will point out some of the difficulties that one encounters when trying to build a bridge between the various 802 LANs due to focus on the following reasons:

1. **Different frame Format**

To start with, each of the LANs uses a different frame format. Unlike the differences between Ethernet, token bus, and token ring, which were due to history and big corporate egos, here the differences are to some extent legitimate. For example, the Duration field in 802.11 is there, due to the **MACAW** protocol and that makes no sense in Ethernet. As a result, any copying between different LANs requires reformatting, which takes CPU time, requires a new checksum calculation, and introduces the possibility of undetected errors due to bad bits in the bridge's memory.

2. **Different data rates**

When forwarding a frame from a fast LAN to a Slower one, the bridge will not be able to get rid of the frames as fast as they come in. Therefore, it has to be buffered. For example, if a gigabit Ethernet is pouring bits into an 11-Mbps 802.11 LAN at top speed, the bridge will have to buffer them, hoping not to run out of memory.

### 3. Different frame lengths

An obvious problem arises when a long frame must be forwarded onto a LAN that cannot accept it. This is the most serious problem. The problem comes when a long frame arrives. An obvious solution is that the frame must be split but, such a facility is not available at the data link layer. Therefore, the solution is that such frames must be discarded.

Basically, there is no solution to this problem.

### 4. Security

Both 802.11 and 802.16 support encryption in the data link layer, but the Ethernet does not do so. This means that the various encryption services available to the wireless networks are lost when traffic passes over the Ethernet.

### 5. Quality of service

The Ethernet has no concept of quality of service, so traffic from other LANs will lose its quality of service when passing over an Ethernet.

## 3.6.1 Transparent Bridges

In the previous section, we dealt with the problems encountered in connecting two different IEEE 802 LANs via a single bridge. However, in large organisations with many LANs, just interconnecting them all raises a variety of issues, even if they are all just Ethernet. In this section, we introduce a type of bridge called Transparent Bridge, which is a plug and play unit which you connect to your network and switch it on. There is no requirement of hardware and software changes, no setting of address switches, no downloading of routing tables, just plug and play. Furthermore, the operation of existing LANs would not be affected by the bridges at all. In other words, the bridges would be completely transparent (invisible to all the hardware and software). Operating in a promiscuous mode, a transparent bridge captures every frame that is transmitted in all the networks to which the bridge is connected. The bridge examines every frame it receives and extracts each frame's source address, which it adds to the backward address table.

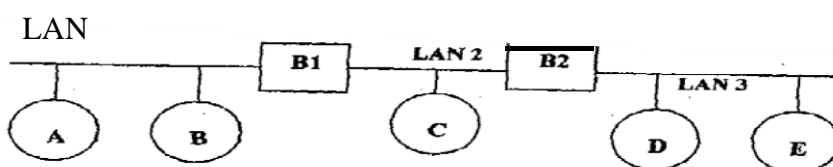

Figure 3.6.1: A network topology with four LANs and two bridges



### Figure 2.49: Three LANS and two bridges

As an example, take the following Confirmation (Figure 2.49). There are 3 LANs: LAN1, LAN2 and LAN3 and two Bridges BI and B2. BI is connected to LAN1 and LAN2 and bridges B2 is connected to LAN2 and LAN3. The routing procedure for an incoming frame depends on the LAN it arrives on (the source LAN) and the LAN its destination is on (the destination LAN), as follows:

1. If destination and source LANs are the same, discard the frame. (For example, packet from A is going to B. Both are on the same LAN i.e. LAN1).
2. If the destination and source LANs are different, forward the frame. (For example, a packet from A on LAN I has to go to D on LAN 3)
3. If the destination LAN is unknown, use flooding.

When the bridges are first plugged in, all its hash tables are empty. None of the bridges know where these destination nodes are exactly. Therefore, they use a flooding algorithm: every incoming frame for an unknown destination is output on all the LANs to which the bridge is connected, except to the one it arrived on. Gradually, the bridges learn where destinations are. Once the destination is known there is no more flooding and the packet is forwarded on the proper LAN.

The algorithm used by the transparent bridges is called backward learning. As mentioned above, the bridges operate in promiscuous mode, so they see every frame sent on any of their LANs. By looking at the source address, they can tell which machine is accessible on which LAN. For example, if bridge B2 in Figure 2.49 sees a frame on LAN 3 coming from D, it knows that D must be reachable via LAN3, so it makes an entry in its hash table noting that frames going to D should use LAN 3.

### 3.6.2 Spanning Tree Bridges

For reliability, some networks contain more than one bridge, which increases the likelihood of networking loops. A networking loop occurs when frames are passed from bridge to bridge in a circular manner, never reaching its destination. To prevent networking loops when multiple bridges are used, the bridges communicate with each other and establish a map of the network to derive what is called a spanning tree for all the networks. A spanning tree consists of a single path between source and destination nodes that does not include any loops. Thus, a spanning tree can be considered to be a loop-free subset of a network's topology. The spanning tree algorithm, specified in IEEE 802.1d, describes how bridges (and switches) can communicate to avoid network loops.

### 3.6.3 Source Routing Bridges

IBM introduced source routing bridges for use in token ring networks. With source routing, the sending machine is responsible for determining whether, a frame is destined for a node on the same network or on a different network. If, the frame is



destined for a different network, then, the source machine designates this by setting the high-order bit of the group address bit of the source address to 1. It also includes in the frame's header the path the frame is to follow from source to destination. Source routing bridges are based on the assumption that a sending machine will provide routing information for messages destined for different networks. By making the sending machine responsible for this task, a source routing bridge can ignore frames that have not been "marked" and forward only those frames with their high-order destination bit set to 1.



## 4.0 CONCLUSION

In this conclusive unit of this module, you have been taken through the two broad topics: Wireless LAN, its standard and Data Link Layer Switching through bridges and Switches.



## 5.0 SUMMARY

In this unit we discussed two major topics wireless LANs and switching mechanism at the data link layer with IEEE at the data link layer. With IEEE 802.11 standardisation, wireless LANs are becoming common in most of the organisations but, they have their own problems and solutions CSMA/CD does not work due to hidden station problem. To make CSMA work better two new protocols, MACA and **MACAW** were discussed. The physical layer of wireless LAN standard i.e. IEEE 802.11 allows five different transmission modes, including infrared, various spread spectrum schemes etc. As a part of inter LANs connecting mechanism we discussed different types of bridges. Bluetooth was not taken up in this unit, although, it is a very important topic today. It is also a wireless network used for connecting handsets and other peripherals to computers without wires.



## 6.0 TUTOR MARKED ASSIGNMENT 8

1. What is Hidden Station Problem?
2. Why CSMA/CD cannot be used in wireless LAN environment? Discuss.
3. How is MACAW different from MACA?
4. What are the features of a transparent bridge?
5. What are the difficulties in building a bridge between the various 802 LANs?



## 7.0 REFERENCES/FURTHER READINGS

Practice Hall of India, (2011). *Computer Networks*, A. S. Tanenbaum 4th Edition, New Delhi.

J.F. Kurose & K. W. Ross, (2003). *Computer Networking*, A Top Down Approach Featuring the Internet, Pearson Edition.

Behrouz Forouzan, (2016). *Introduction to Data Communication & Networking*, Tata McGraw Hill.

Leon Garcia, and Widjaja, (2000). *Communications Networks*, Tata McGraw Hill.

William Stallings, *Data and Computer Communications*, 6th Edition, Pearson Education, New Delhi, 2003.

## **8.0 ANSWERS TO TUTOR MARKED ASSIGNMENT 8**

### **Question 1**

What is Hidden Station Problem?

### **Solution**

This is a situation in wireless LAN transmission where two or more stations who are out of range of each other/one another communicate to the same recipient

### **Question 2**

Why CSMA/CD cannot be used in wireless LAN environment? Discuss.

### **Solution**

CSMA/CD cannot be used in wireless LAN environment because there is no way for the source of information can sense collisions the same way CSMA/CD does on a physical medium since the source is only able to communicate and obtain packets on the channel but is not able to sense data crossing that channel.

### **Question 3**

How is MACAW different from MACA?

### **Solution**

Multiple Access with Collision Avoidance (MACA) enables nodes give information of sending data frame for others to remain silent in a wireless network. However, collision can still exist in wireless LAN with MACA, hence the need for MACA for Wireless (MACAW). In MACAW, nodes are requested to send acknowledgments after every fruitful frame communication. This is mostly used in ad-hoc network and is the foundation of numerous other MAC protocols that exist in wireless **sensor networks (WSN)**.

### **Question 4**

What are the features of a transparent bridge?

### **Solution**

Some of the features of transparent bridges are fast convergence time, low network overhead, easier configuration and less CPU consumption.

### **Question 5**

What are the difficulties in building a bridge between the various 802 LANs?

### **Solution**

The difficulties in building a bridge between the various 802 LANs are:

The LANs use a different frame format

The interconnected LANs do not necessarily run at the same data rate

The different 802 LANs have different maximum frame lengths

Both 802.11 and 802.16 support encryption in the data link layer but Ethernet does not.

The issues of the quality of service is another point. Both 802.11 and 802.16 provide it in various forms, the former using PCF mode and the latter using constant bit rate connections

Note: Explain them

## **MODULE 3 NETWORK LAYER**

Unit 1	Introduction to Layer Functionality and Design Issues
Unit 2	Routing Algorithms
Unit 3	Congestion Control in Public Switched Network
Unit 4	Internetworking

### **UNIT 1 INTRODUCTION TO LAYER FUNCTIONALITY AND DESIGN ISSUES**

#### **CONTENTS**

1.0	Introduction
2.0	Objectives
3.0	Main Content
3.1	Connection Oriented vs. Connection-less Services
3.1.1	Connection-oriented Services
3.1.2	Connection-less Services
3.2	Implementation of the Network Layer Services
3.2.1	Packet Switching
3.2.2	Implementation of Connection -oriented Services
3.2.3	Implementation of Connection-less Services
3.3	Comparison between Virtual Circuit and Datagram Subnet
3.4	Addressing
3.4.1	Hierarchical versus Flat Address
3.4.2	Static vs Dynamic Address
3.4.3	IP Address
3.5	Concept of Congestion
3.6	Routing Concept
3.6.1	Main Issues in Routing
3.6.2	Classification of Routing Algorithm
4.0	Conclusion
5.0	Summary
6.0	Tutor-Marked Assignment



## 1.0 INTRODUCTION

In the previous blocks of this course, we have learned the basic functions of physical layer and data link layer in networking. Now, in this chapter, we will go through the functions of the network layer.

The network layer is at level three in OSI model. It responds to service requests from the transport layer and issues service requests to the data link layer. It is responsible for end-to-end (source to destination) packet delivery, whereas the data link layer is responsible for node-to-node (hop-to-hop) packet delivery. Three important functions of the network layers are:

### 1. Path Determination

It determines the route taken by the packets from the source to the destination.

### 2. Forwarding

It forwards packets from the router's input to the appropriate router output.

### 3. Call Setup

Some network architectures require router call setup along the path before the data flows. To perform these functions, the network layer must be aware of the topology of the communication subnet (i.e., set of routers, communication lines).

For end-to-end delivery, the network provides two type of services i.e., **connection-oriented service** and **connectionless service** to the transport layer. The network layer services meet the following entries [ref.1].

- a. Transport layer should not be aware of the topology of the, network (subnet).
- b. Services should be independent of the router technology.

In this unit, we will first go through the basic concepts of these services and will then differentiate between these two. Then, we will introduce some other concepts like routing and congestion.



## 2.0 OBJECTIVES

After going through this unit, you should be able to:

1. define basic functions of the network layer
2. differentiate between connection oriented and connection less services
3. define the concept of addressing in networking

4. define congestion in the network layer
5. explain the concept of routing
6. explain the concept of **packet** switching
7. define packet switching network.



## 3.0 MAIN CONTENT

### 3.1 Connection Oriented vs. **Connectionless** Services

In computer networks, delivery between source and destination can be accomplished in either of the two ways:

1. Connection-oriented services
2. Connection-less services.

#### 3.1.1 Connection-Oriented Services

Connection-oriented services define a way of transmitting data between a sender and a receiver, in which an end-to-end connection is established before sending any data. After establishing a connection, a sequence of packets, (from the source to **destination**), can be sent one after another. All the packets belonging to a message are sent from the same connection. When all packets of a message have been delivered, the connection is terminated.

**In connection-oriented services, the devices at both the endpoints use a protocol to establish an end-to-end connection before sending any data.**

Connection-oriented service usually has the following characteristics:

1. The network guarantees that all packets will be delivered in order without loss or duplication of data.
2. Only a single path is established for the call. and all the data follows that path.
3. The network guarantees. a minimal amount of bandwidth and this bandwidth is reserved for the duration of the call.
4. If the network is over utilised, future call requests are refused.

Connection-oriented service is sometimes called a “reliable” network service because:

- a. It guarantees that data will arrive in the proper sequence.
- b. Single connection for entire message facilitates acknowledgement process and retransmission of damaged and lost frames.

Connection-oriented transmission has three stages. These are:

#### 1. Connection establishment

In connection-oriented services, before transmitting data, the sending device must first determine the availability of the other to exchange data and a connection must be established by which data can be sent. Connection establishment requires three steps. These are:

- a. First the sender computer requests the connection by sending a connection request packet to the intended receiver.
- b. Then the receiver computer returns a confirmation packet to the requesting computer.
- c. Finally, the sender computer returns a packet acknowledging the confirmation.

## 2. Data transfer

After the connection gets established, the sender starts sending data packets to the receiver.

## 3. Connection termination

After all the data gets transferred, the connection has to be terminated. Connection termination also requires a three-way handshake i.e.:

- a. First, the sender computer requests disconnection by sending a disconnection request packet.
- b. Then, the receiver computer confirms the disconnection request.
- c. Finally, the sender computer returns a packet acknowledging the confirmation.

**Transmission Control Protocol (TCP)** is a connection-oriented protocol.

### 3.1.2 Connection-less Services

Connection-less services define a way of communication between two network end points in which, a message can be sent from one end point to another without prior arrangement. The sender simply starts sending packets, addressed to the intended recipient.

**Connectionless service is a service that allows the transfer of information among subscribers without the need for end-to-end connection establishment procedures.**

Connection-less service is sometimes known as “**unreliable**” network service. Connection-less protocols are usually described as stateless because the endpoints have no protocol-defined way of remembering where they are in a “conversation” of message exchange.

The **Internet Protocol (IP) and User Datagram Protocol (UDP)** are connectionless protocols, but TCP/IP (the most common use of IP) is connection-oriented.

## 3.2 Implementation of the Network Layer Services

In this section, we will examine how the network layer services are implemented. Two different services are taken into consideration depending on the type of service being offered. These two schemes are known as virtual circuit subnet (VC subnet) for connection-oriented service and datagram subnet for connection-less services. A VC subnet may be compared to the physical circuit required in a telephone setup. In a connection-oriented service, a route from the source to the destination must be established. In a datagram subnet, no advance set up is needed. In this case, packets are routed independently. But, before we take up the implementation issues let us, revisit the packet switching concepts once again. The services are implement through a packet switched network.

### 3.2.1 Packet Switching

In the fourth unit of Block I, we introduced the concept of packet switching. We further elaborate in this section, in the context of the network layer. The network layer operates in the packet switched network (or subnet) environment which comprises several routers linked with transmission lines (leased or dial up) besides user's machines as shown in [Figure 3.1](#).

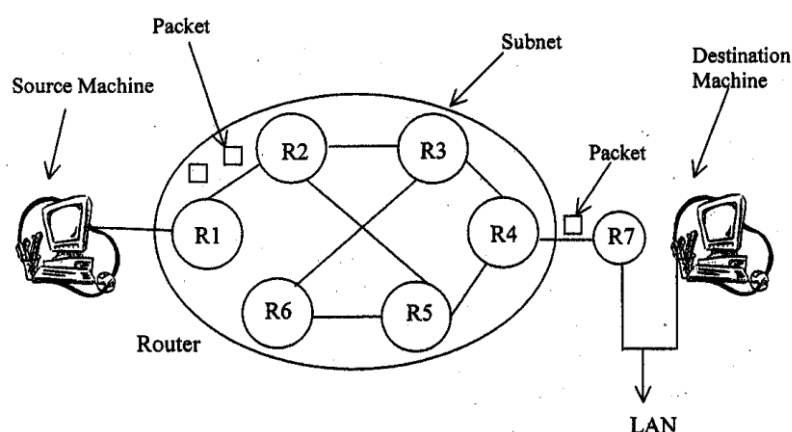

[Figure 3.1: A Packet switched network](#)

This subnet works in the following manner. Whenever user wants to send a packet to another users, **the packet is transmitted to** the nearest router either on its own LAN or over a point-to-point link to the carrier. The packet is stored for verification and then transmitted further to the next router along the way until it reaches the final destination machine. This mechanism is called packet switching.

But, why packet switching? Why not circuit switching? Now, let us discuss these issues.

Circuit switching was not designed for packet transmission. It was primarily designed for voice communication. It creates temporary (dialled) or permanent (leased) dedicated links that are well suited to this type of communication [[Ref 2](#)].

- (i) Data transmission tends to be busy, which means that packets arrive in spurts with gaps in between. In such cases, transmission lines will be mostly idle leading to wastage of resources if we use circuit switching for data transmission.
- (ii) **Single Data Rate:** In circuit switching mechanism there is a single data rate for the two end devices which limits flexibility and usefulness of circuit switched connection for networks interconnection of a variety of digital devices.
- (iii) **No priority to transmission:** Circuit switching treats all transmissions as equal. But often, with data transmission we may be required to send a certain packet on a high priority basis, which may not be implemented with the circuit switching approach.

### 3.2.2 Implementation of Connection-oriented Services

To implement connection-oriented services, we need to form a virtual- circuit subnet. This idea behind the creation of a VC is so that, a new route for every packet sent. In virtual circuits:

1. First, a connection needs to be established.
2. After establishing a connection, a route from the source machine to the destination machine is chosen as part of the connection setup and stored in tables inside the routers. This route is used for all traffic flowing over the connection.
3. After transmitting all the data packets, the connection is released. When the connection is released, the virtual circuit is also terminated.

In a connection-oriented service, each packet carries an identifier that identifies the virtual circuit it belongs to.

Now, let us take an example, consider the situation of a subnet in [Figure 3.2](#). In this figure, H1, H2 and H3 represent host machines and R1, R2, R3, R4, R5 and R6 represent routers. Processes are running on different hosts.

Here, host H1 has established connection 1 with host H2. It is remembered as the first entry in each of the routing tables as shown in [Table 3.1](#). The first line of R1's table says that, if a packet bearing connection identifier 1 comes in from H1, it is to be sent to router R3, and given connection identifier 1. Similarly, the first entry at R3 routes the packet to R5, also with connection identifier 1.

Now, let us consider a situation in which, H3 also wants to establish a connection with H2. It chooses connection identifier I (because it is initiating the connection and this is its only connection) and informs the subnet to setup the virtual circuit. This leads to the second row in the table. Note, that we have a conflict here because although R1 can easily distinguish -connection I packets from H1 and connection I packets from H3, R3 cannot do this. For this reason, R1 assigns a different connection identifier to



the outgoing traffic for the second connection (No.2). In order to avoid conflicts of this nature, it is important that routers have the ability to replace connection identifiers in outgoing packets. In some contexts, this is called **label switching**.

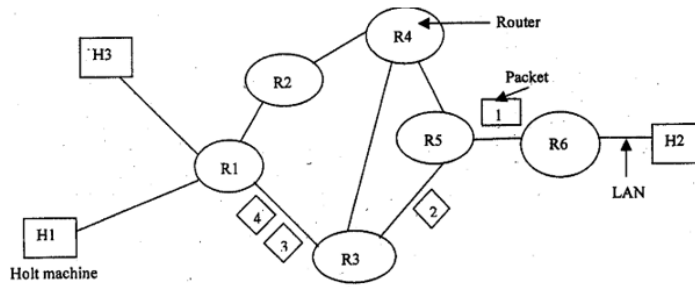

Figure 3.2: Routing in a virtual subnet

R1's Table		R3's Table	
H1	1	R3	1
H3	1	R3	2
in		out	

R3's Table		R5's Table	
R1	1	R5	1
R1	1	R5	2
in		out	

R5's Table		R6's Table	
R3	1	R6	1
R3	1	R6	1
in		out	

Figure 3.3: Routing table for VC subnet

### 3.2.3 Implementation of Connection-less Services

In this section, we shall discuss the implementation of these services i.e., how connection-less services are implemented in real networks. To implement connection-less services, we need a datagram subnet.

In these services, packets are individually injected into the subnet and their routing decisions are not dependent on each other (packets). Therefore, in connectionless services, no advance setup is needed. In this context, the packets are frequently called **datagrams** and the subnet is called a **datagram subnet**.

Now, let us take an example to learn how a datagram subnet works.

Consider the situation of **Figure 3.4**. In this Figure, H1 and H2 represent host machines and R1, R2, R3, R4, R5 and R6 represent routers. Suppose, that the process running at host H1 has a long message to be transmitted to a process running at H2 machine. To do so, it transfers the message to the transport layer with appropriate instructions to deliver it to the process running at H2. Where is the transfer layer process running, can you figure out? Well, it may also be running on H1 but within the operating system. The transport layer process adds a transport header to the front of the message and transfers the message (also called TPDU) to the network layer. The network layer too, might be running as another procedure within the operating system.

Let us assume, that the message is five times longer than the maximum packet size, therefore, the network layer has to break it into five packets, 1,2, 3, 4 and 5 and send each of them in turn to router R1 (because it is linked to R1) using some point-to-point protocol. After this, the carrier (supported by ISP) takes over. Every router has an internal table telling it where to send packets for each possible destination. Each table entry is a pair consisting of a destination and the outgoing line to use for that destination. Only directly-connected lines can be used. For example, in **Figure 3.4**, R1 has only two outgoing lines-to R2 and R3. So, every incoming packet must be sent to one of these routers.

As the packets arrive at R1 from H1, packets 1, 2, and 3 were stored briefly (to verify their checksums). Then, each packet was forwarded to R3 according to R1 's table (table not shown here). Packet 1 was then forwarded to R5 and from R5 to R6. When it got to R6, it was encapsulated in a data link layer frame and sent to H2. Packets 2 and 3 follow the same route.

However, something different happened to packet 4 and 5. When it got to R1 it was sent to router R2, even though it has the same destination. Due to some reason (for ex. congestion), R1 decided to send packet 4 and 5 via a different route than that of the first three.

The algorithm that manages the tables and makes the routing decisions is known as the routing algorithm. In next unit, we shall study *routing algorithms*. Students are requested to refer to [Ref. I] for further study on the implementation of connection oriented and connection less services. You should focus on connecting routing tables.

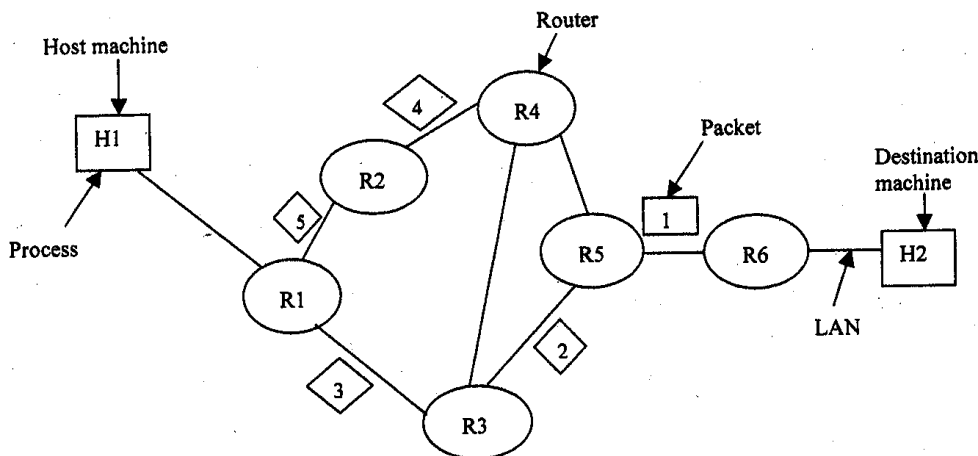

**Figure 3.4: Routing in a datagram subnet**

### 3.3 Comparison between Virtual Circuit and Datagram Subnet

Both virtual circuits and datagrams have their pros and cons. We shall compare them on the basis of different parameters. These various parameters are:

#### 1. Router memory space and bandwidth

Virtual circuits allow packets to contain circuit numbers instead of full destination addresses. A full destination address lit every packet may represent a significant amount of overhead, and hence waste bandwidth.

#### 2. Setup time vs. address parsing time

Using virtual circuits requires a setup phase, which takes time and consumes memory resources. However, figuring out what to do with a data packet in a virtual-circuit subnet is easy: the router simply uses the circuit number to index into a table to find out where the packet goes. In a datagram subnet, a more complicated lookup procedure is required to locate the entry for the destination.

#### 3. Amount of table space required in router memory

A datagram subnet needs to have an entry for every possible destination, whereas a virtual-Circuit subnet just needs an entry for each virtual circuit.

#### 4. Quality of service

Virtual circuits have some advantages in guaranteeing quality of service and avoiding congestion within the subnet because resources (e.g., buffers, bandwidth, and CPU cycles) can be reserved in advance, when the connection is established. Once the packets start arriving, the necessary bandwidth and router capacity will be there. With a datagram subnet, congestion avoidance is more difficult.

#### 5. Vulnerability

Virtual circuits also have a vulnerability problem. If, a router crashes and loses its memory, even if it comes back a second later, all the virtual circuits passing through it will have to be aborted. In contrast, if a datagram router goes down, only those users whose packets were queued in the router at the time will suffer, and maybe not even all those, depending upon whether they have already been acknowledged. The loss of a communication line is fatal to virtual circuits using it but can be easily compensated for if datagrams are used.

#### 6. Traffic balance

Datagrams also allow the routers to balance the traffic throughout the subnet, since routes can be changed partway through a long sequence of packet transmissions. A

brief comparison between a virtual circuit subnet and a datagram subnet is given in figure 3.5. Students should refer to Reference 1 for further discussion.

Issue	Datagram subnet	Virtual-circuit subnet
Addressing machine	Each datagram contains the full source and destination address	Each datagram contains a Small VC number
Referencing of Circuit setup	Not needed	Required
State information by a router	Routers do not hold state information about connections.	Each VC requires router table space per connection.
Routing procedure	Each datagram is routed independently.	Route is selected when VC is set up and all the packets follow all routes.
Effect of router failures	None, except the datagram lost during the crash	All VCs that passed through the failed router are terminated and the new virtual circuit is established
Quality of service	Difficult	Easy
Congestion control mechanism	Difficult	Easy

Table 3.5: Comparison between Virtual Circuit and Datagram Subnets (Source: Ref. [1])

### SELF-ASSESSMENT EXERCISE 7

Give right choice for the following:

1. Connection-oriented service is sometimes called a network service.
  - a Reliable
  - b Unreliable
  
2. ....is a connection-oriented protocol.
  - a UDP
  - b TCP
  - c IP
  
3. Why are connection oriented services known as reliable services? Explain briefly.

### 3.4 Addressing

Network addresses identify devices separately or as members of a group. Addressing is performed on various layers of the OSI model. Thus, schemes used for addressing vary on the basis of the protocol used and the OSI layer. On this basis, internetwork addresses can be categorised into three types. These are:

- 1 Data link layer addresses
- 2 Media Access Control (MAC) addresses

### 3 Network layer addresses.

#### 1 Data Link Layer Addresses

Data-link layer addresses sometimes are referred to as physical or *hardware addresses*, uniquely identify each physical network connection of a network device. Usually data-link addresses have a pre-established and fixed relationship to a specific device.

End systems generally have only one physical network connection and thus, have only one data-link address. Routers and other internetworking devices typically have multiple physical network connections and therefore, have multiple data-link addresses.

#### 2 Media Access Control (MAC) Addresses

Media Access Control (MAC) addresses are used to identify network entities in LANs that implement the IEEE MAC addresses of the data link layer. These addresses are 48 bits in length and are expressed as 12 hexadecimal digits.

MAC addresses are unique for each LAN interface. These addresses consist of a subset of data link layer addresses. *Figure 4* illustrates the relationship between MAC addresses, data-link addresses, and the IEEE sub-layers of the data link layer.

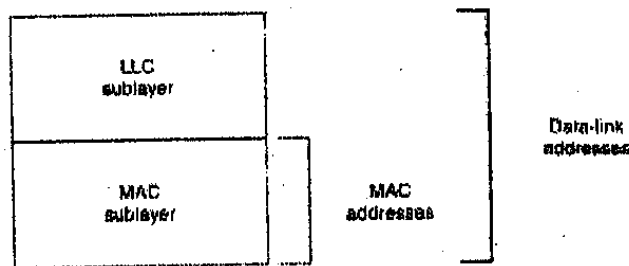

Figure 3.6: MAC addresses, data-link addresses, and the IEEE Sub-layer, of the data link layer are all related

### 3. Network Layer Addresses

Network addresses are sometimes called virtual or logical addresses. These addresses are used to identify an entity at the network layer of the OSI model. Network addresses are usually hierarchical addresses.

#### 3.4.1 Hierarchical vs. Flat Address

Usually Internetwork addresses are of two types:

##### 1 Hierarchical address

Hierarchical addresses are organised into a number of subgroups, each successively narrowing an address until it points to a single device as a house address.

## 2 Flat address

A flat address space is organised into a single group, such as. your enrolment no. Hierarchical addressing offers certain advantages over flat-addressing schemes. In hierarchical addressing, address sorting and recalling is simplified using the comparison operation. For example, “India” in a street address eliminates any other country as a possible location. **Figure 3.7** illustrates the difference between hierarchical and flat address spaces.

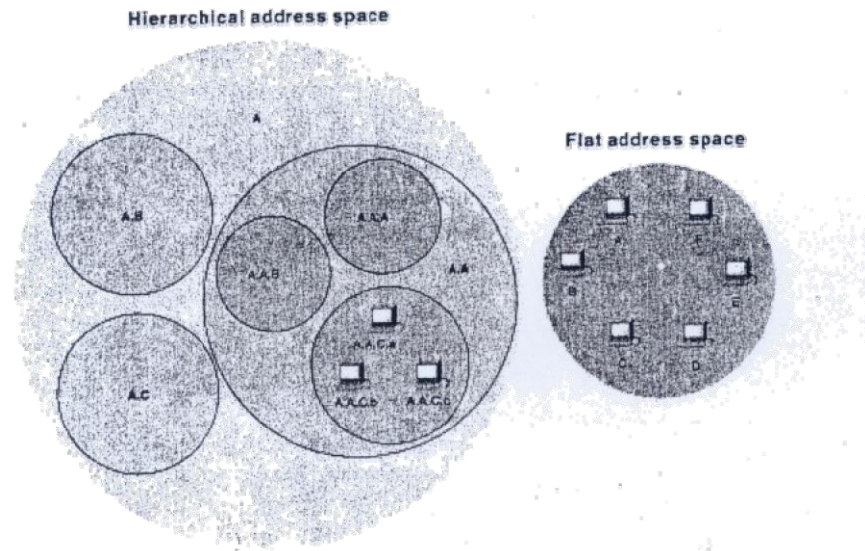

**Figure 3.7:** Hierarchical and flat address spaces differ in comparison operations

### 3.4.2 Static vs. Dynamic Address

In networking, the address to a device can be assigned in either of these two ways:

#### (i) Static address assignment

Static addresses are assigned by a network administrator according to a preconceived internetwork addressing plan. A static address does not change until the network administrator changes it manually.

#### (ii) Dynamic addresses

Dynamic addresses are obtained by devices when they are attached to a network, by means of some protocol-specific process. A device using dynamic address often has a different address each time it connects to the network.

### 3.4.3 IP Address

IP address is a unique address i.e., no two machines on the Internet can have same IP address. It encodes its network number and host number. Every host and router, in an internetwork has an IP address.

The format of an IP address is a 32-bit numeric address written as four numbers separated by periods. Each number can be zero to 255. For example, 1.160.10.240 could be an IP address. These numbers define three fields as shown below and in figure 3.8:

- 1 **Class type:** Indicate the IP class, to which the packet belongs:
- 2 **Network identifier (netid):** Indicates the network (a group of computers). Networks with different identifiers can be interconnected with routers.
- 3 **Host identifier (hostid):** Indicates a specific computer on the network.

Class type	Netid	Hostid
------------	-------	--------

Figure 3.8: IP address

You will read more details on IP address in unit 4.

### 3.5 Concept of Congestion

In the network layer, when the number of packets sent to the network is greater than the number of packets the network can handle (capacity of network), a problem occurs that is known as congestion. This is just like congestion on a road due to heavy traffic. In networking, congestion occurs on shared networks when, multiple users contend for access to the same resources (bandwidth, buffers, and queues).

When the number of packet sent into the network is within the limits, almost all packets are delivered, however, the traffic load increases beyond the network capacity. As a result the system starts discarding packets.

Figure 3.9 shows congestion in a network due to too much traffic.

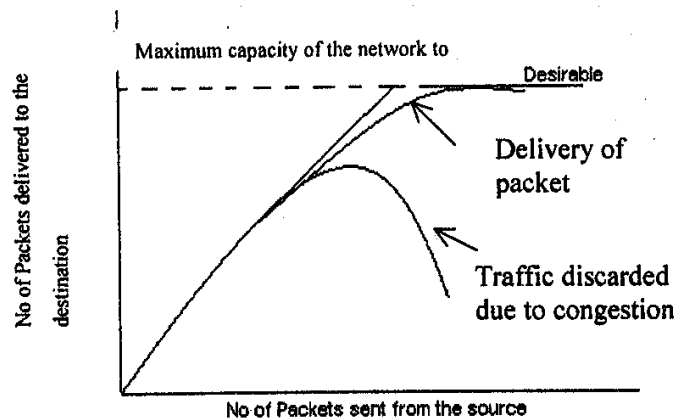

Figure 3.9: Congestion

Because routers receive packets faster than they can forward them, one of these two things may happen in case of congestion:

- a The subnet may prevent additional packets from entering the congested region until those already present can be processed, or
- b The congested routers can discard queued packets to make room for those that are arriving currently.

## **Congestion Control**

Congestion control refers to the network mechanism and techniques used to control congestion and keep the load below the network's capacity.

Congestion handling can be divided into the following:

1. **Congestion recovery:** Restore the operating state of the network when demand exceeds capacity.
2. **Congestion avoidance:** Anticipate congestion and avoid it so that congestion never occurs.

By storing content closer to users i.e., caching can be the best congestion control scheme. In this manner, majority of the traffic could be obtained locally rather than being obtained from distant servers along routed paths that may experience congestion.

Some basic techniques to manage congestion are:

### 1 **End-system flow control**

This is not a congestion control scheme. It is a way of preventing the sender from overrunning the buffers of the receiver.

### 2 **Network congestion control**

In this scheme, end systems throttle back in order to avoid congesting the network. The mechanism is similar to end-to-end flow controls, but the intention is to reduce congestion in the network, not at the receiver's end.

### 3 **Network-based congestion avoidance**

In this scheme, a router detects that congestion may occur and attempts to slow down senders before queues become full.

### 4 **Resource allocation**



This technique involves scheduling the use of physical circuits or other resources, perhaps for a specific period of time. A virtual circuit, built across a series of switches with a guaranteed bandwidth is a form of resource allocation. This technique is difficult, but can eliminate network congestion by blocking traffic that is in excess of the network capacity.

### 3.6 Routing Concept

Suppose, you need to go from location (A) to another location (B) in your city and more than one routes are available for going from location A to location B. In this case, first you decide the best route for going from location A to B. This decision may be based on a number of factors such as distance (route with minimum traffic distance), time (route with minimum traffic jam), cost etc. After deciding the best route, you start moving on that route. The same principle is at work here, in computer networks also. While transferring data packets in a packet switched network the same principle is applied, and this is known as routing. Now, we can say that *routing is the act of moving **duck** to packets in packet-switched network from a source to a destination.* Along the way, several intermediate nodes typically are encountered.

Routing occurs at Layer 3 (the network layer) in OSI reference model. It involves two basic activities:

- 1 Determining optimal routing paths.
- 2 Forwarding packets through a subnet. In this section, we will look at several issues related to routing.

#### 3.6.1 Main Issues in Routing

Routing in a network typically involves a rather complex collection of algorithms that work more or less independently mainly due to the environment in which it works and yet support each other by exchanging services or information. The complex is due to a number of reasons. First, routing requires coordination between all the nodes of the subnet rather than just a pair of modules as, for example, in data link and transport layer protocols. Second, the routing system must cope with transmission link and router failures, requiring redirection of traffic resetting up of new VC and an update of the routing tables databases maintained by the system. Third, to achieve high performance, the routing algorithm may need to modify its routes when some areas within the network become congested.

There are two main performance measures that are substantially affected by the routing algorithm -throughput (quantity of service) and latency (average packet delay when quality of service is required). The parameter **throughput** refers to the number of packets delivered in the subnet. Routing interacts with **flow control** in determining these performance measures by means of a feedback mechanism **shown** in **Figure 3.10**. When the traffic load offered by the external resources to the subnet is within the limits of the carrying capacity of the subnet, it will be fully accepted into the network, that is, **network throughput=offered packets**.

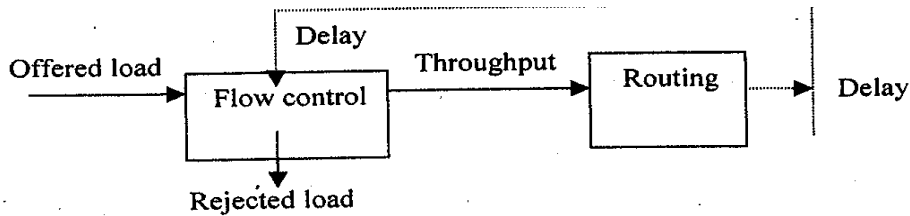

Figure 3. 10: interaction of routing and now control

But, when the offered load exceeds the limit, the packet will be rejected by the flow control algorithm and

$$\text{Network Throughput} = \text{offered packets} - \text{rejected packets}$$

The traffic accepted into the network will experience an average delay per packet that will depend on the routes chosen by the routing algorithm.

However, throughput will also be greatly affected (if only indirectly) by the routing algorithm because typical flow control schemes operate on the basis of striking a balance between throughput and delay. Therefore, as the routing algorithm is more successful in keeping delay low, the flow control algorithm allows more traffic into the network, while the precise balance between delay and throughput will be determined by flow control, the effect of good routing under high offered load conditions is to realise a more favourable delay-throughput curve along which flow control operates, as shown in Figure 3.11.

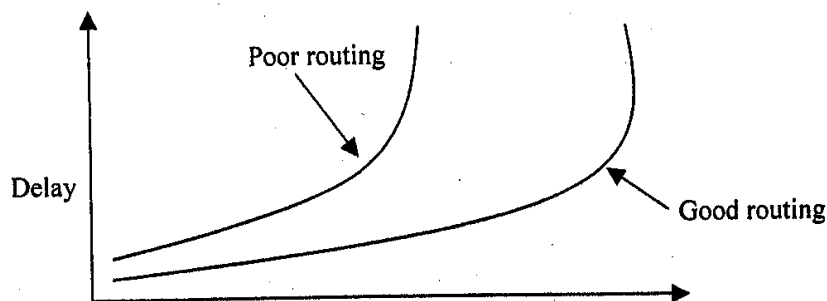

Throughput (Source Ref [2])

Figure 3.11: Throughput vs. delay graph

Let us take an example to understand the intimacy. In the network of Figure 3.12, all links have a capacity of 10units. There is a single destination (R6) and two origins (R1 and R2). The offered packets from each of R1 and R2 to R5 and R6 is 5 units. Here, the offered load is light and can easily be accommodated with a short delay by routing along the leftmost and rightmost paths, 1-3-6 and 2-5-6, respectively. If instead, however, the routes 1-4-6 and 2-4-6 are used, the flow on link (4,6) with equal capacity, resulting in very large delays.

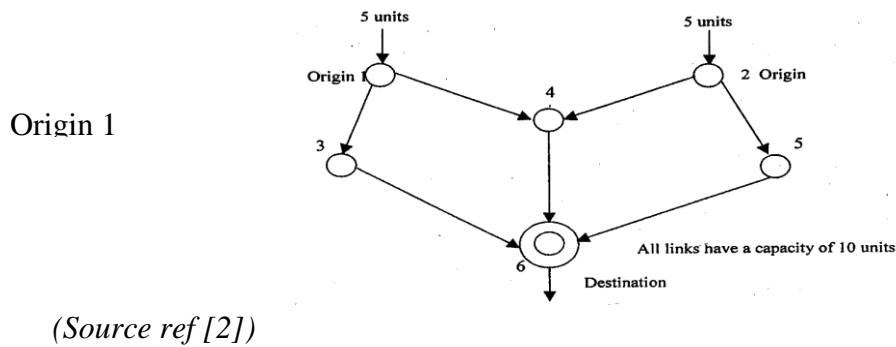

Figure 3.12: Example a sub network

Observe Figure 3.12 once again. All links have a capacity of 10 units. If, all traffic is routed through the middle link (R4,R6), congestion occurs. If, instead, paths (R1 -R3-R6) and (R2-R3-R6) are used, the average delay is shorter/lessees.

In conclusion, the effect of good routing is to increase throughput for the same value of average delay per packet under high offered load conditions and decrease average delay per packet under low and moderate offered load conditions. Furthermore, it is evident as low as possible for any given level of offered load. While this is easier said than done, analytically. Students are requested to refer to (Ref 2) for further discussion. You are requested to further enhance your knowledge by reading [Ref 2].

## 1.7.2 Classification of Routing Algorithm

Routing can be classified into the following types:

### 1 Adaptive Routing

In adaptive routing; routing decisions are taken for each packet separately i.e., for the packets belonging to the same destination, the router may select a new route for each packet. In it, routing decisions are based on condition or the topology of the network.

### 2 Non-adaptive Routing

In non-adaptive routing; routing decisions are not taken again and again i.e., once the router decides a route for the destination, it sends all packets for that destination on that same route. In it routing decisions are not based on condition or the topology of the network.



## 4.0 CONCLUSION

In this unit, you have been introduced to **concepts** pertaining to the network layer functionalities. You have also been introduced to the important services provided by the network layer. It is therefore expected that by now after going through this **unit** you will be able to differentiate between them and also describe how they are to **be** implemented.

You have also learnt the concept of routing and congestion as well as the interaction between routing and flow control.



## 5.0 SUMMARY

In this unit, we looked at the two types of end-to-end delivery services in computer networks i.e., connection-oriented service and connection less service. Connection oriented service is a reliable network service, while connection-less service is unreliable network service. Then we studied the concept of addressing. A network **address** identifies devices separately or as **members** of a group. Internetwork addresses can be categorised into three types i.e., data link layer addresses, media access control (MAC) addresses and network layer addresses. After this, we studied a problem that occurs at the network layer level i.e., congestion. It is a problem that occurs due to overload on the network. Then, we discussed routing. It is the act of moving data packets in packet-switched network, from a source to a destination. We also examined the relationship between routing and flow control through an example and diagrams.



## 6.0 SELF ASSESSMENT EXERCISE 6

Give right choice for the following:

- 1) Connection-oriented service is sometimes called a network service.
  - (a) Reliable
  - (b) Unreliable
- 2) .....is a connection-oriented protocol.
  - (a) UDP
  - (b) TCP
  - (c) IP
- 3) Why are connection-oriented services known as reliable services?  
Explain briefly



## 7.0 TUTOR MARKED ASSIGNMENT 9

1. What are three types of internet work addresses? Explain in brief.
2. Differentiate between following:
  - a Hierarchical address and Flat address
  - b Static and Dynamic address.
3. What is congestion in the network? Explain in brief.
4. Explain various congestion control schemes.
5. What is routing? What are various activities performed by a router?
6. Differentiate between adaptive and non-adaptive routing.



## 7.0 REFERENCES/FURTHER READINGS

A, S, Tanenbaum, (2002). *Computer Network*, 4<sup>th</sup> edition, Prentice Hall of India, New Delhi, 2011.

Dmitri Bertekas and Robert Gallego, (1997). *Data Network*, Second edition, Prentice Hall of India, New Delhi.

## 8.0 ANSWERS TO SELF ASSESSMENT EXERCISE 6

Give right choice for the following:

- 1) Connection-oriented service is sometimes called a network service.  
(a) Reliable ✓  
(b) Unreliable
- 2) .....is a connection-oriented protocol.  
(a) UDP  
(b) TCP ✓  
(c) IP
- 3) Why are connection-oriented services known as reliable services?  
Explain briefly

### Solution

connection-oriented services known as reliable services because it allows connection to be established between the caller and the receiver before any transmission and it makes sure data arrives in the same order it was sent.

## 9.0 ANSWERS TO TUTOR MARKED ASSIGNMENT 9

### Question 1

What are three types of internet work addresses? Explain in brief.

### Solution

The three types of Internet work addresses are:

- a. data-link layer **addresses**,

A data-link layer **address** distinctively finds each physical network linking of a network device.

- b. Media Access Control (MAC) **addresses**, and

Media Access Control (MAC) addresses comprise of a subgroup of data-link layer addresses. MAC addresses find network entities in LANs that effect the IEEE MAC addresses of the data-link layer

- c. network-layer **addresses**

A network-layer address finds an entity at the network layer of the OSI layers. Network addresses typically exist inside a classified address space and occasionally are called virtual or logical addresses.

## **Question 2**

Differentiate between following:

- (i) Hierarchical address and Flat address
- (ii) Static and Dynamic address.

## **Solution**

Different between Hierarchical address and Flat address

Internet network address space occasionally have one of two forms: hierarchical address space or flat address space. A hierarchical address space is arranged into many subdivisions, each consecutively thinning an address until it becomes a single device just like street addresses. A flat address space is arranged into a single division just like U.S. Social Security numbers.

A static address remains the same and does not change while a dynamic address changes as the need arise.

## **Question 3**

What is congestion in the network? Explain in brief.

## **Solution**

Network congestion in data networking and queueing theory is the reduced quality of service that occurs when a network node or link is carrying more data than it can handle. Typical effects include queueing delay, packet loss or the blocking of new connections.

## **Question 4**

Explain various congestion control schemes.

## **Solution**

Congestion control schemes can be divided into two:

- a. Open Loop Congestion Control
- b. Closed Loop Congestion Control

Open Loop Congestion Control

- i. Retransmission Policy
- ii. Window Policy
- iii. Discarding Policy
- iv. Acknowledgment Policy
- v. Admission Policy

Closed Loop Congestion Control

- i. Backpressure
- ii. Choke Packet Technique
- iii. Implicit signalling
- iv. Explicit signalling
  - Forward signalling

- Backward signalling

Explain them

### **Question 5**

What is routing? What are various activities performed by a router?

### **Solution**

Routing is the process of selecting a path for traffic in a network or between or across multiple networks. Broadly, routing is performed in many types of networks, including circuit-switched networks, such as the public switched telephone network, and computer networks, such as the Internet.

The function of router is to direct traffic on the Internet and guide against signal interference in the process.

### **Question 6**

Differentiate between adaptive and non-adaptive routing.

### **Solution**

Adaptive route made routing decision depending on the network traffic and layout while nonadaptive routing does not make decision depending on the network traffic and layout.

## UNIT 2 ROUTING ALGORITHMS

### CONTENTS

- 1.0 Introduction
- 2.0 Objectives
- 3.0 Main Content
  - 3.1 Flooding
  - 3.2 Shortest Path Routing Algorithm
  - 3.3 Distance Vector Routing
    - 3.3.1 Comparison
    - 3.3.2 The Count-to-infinity Problem
  - 3.4 Link State Routing
  - 3.5 Hierarchical Routing
  - 3.6 Broadcast Routing
  - 3.7 Multicast Routing
- 4.0 Conclusion
- 5.0 Summary
- 6.0 Tutor-Marked Assignment
- 7.0 References/Further Readings



### 1.0 INTRODUCTION

As you have studied earlier, the main function of the network layer is to find the best route from a source to a destination. In routing, the route with the minimum cost is considered to be the best route. For this purpose, a router plays an important role. On the basis of cost of each link, a router tries to find the optimal route with the help of a good routing algorithm. There are large number of routing algorithms. These algorithms are part of the network layer and are responsible for deciding on which output line an incoming packet should be transmitted. Some of these routing algorithms are discussed in this unit.



### 2.0 OBJECTIVES



After going through this unit, you should be able to:

- 1 understand how the shortest path routing algorithm works
- 2 draw a spanning tree
- 3 understand the functioning of distance vector routing and link state routing understand and implement multicast routing.



## 3.0 MAIN CONTENT

### 3.1 Flooding

Consider an example of any network topology (VC subnet) in which, there are some link failures or in which, a few routers are not operational. These failures will cause changes in the network topology which have to be communicated to all the nodes in the network. This is called broadcasting. These could be many such examples of broadcasting in which the message has to be passed on to the entire network.

A widely used broadcasting method, known as **flooding**, operates in the following manner. The source node sends its information in the form of a packet to those nodes in a subnet to which it is directly connected by a link. These nodes relay it further to their neighbours who are also directly connected, and so on, until the packet reaches all nodes in the network. For example, in the **Figure 3.13(a)**, R1 will send its packets to R2 and R3. R2 will send the packet to R5 and R4. Two additional rules are also applied in order to limit the number of packets to be transmitted. First, a node will not relay the packet back to the node from which the packet was obtained. For example, R2 will not send the packet back to R1 if, it has received it from R1. Second, a node will transmit the packet to its neighbours at most once; this can be ensured by including on the packet the number of the origin node and a sequence number, which is incremented with each new packet issued by the origin node. By storing the highest sequence number received for each node, and by not relaying packets with sequence numbers that are less than or equal to the one stored, a node can avoid transmitting the same packet more than once, on each of its incident links. On observing these rules, you will notice that, links need not preserve the order of packet transmissions; the sequence numbers can be used to recognise the correct order. The following figure gives an example of flooding and illustrates how, the total number of packet transmission per packet broadcast lies between  $L$  and  $2L$ , where  $L$  is the number of bi-directional links of the network. In this **Figure 3.13(a)** Packet broadcasting from router R1 to all other nodes by using flooding [as in **Figure 3.13(a)**] or a spanning tree [as in **Figure 3.13(b)**]. Arrows indicate packet transmissions at the time shown. Each packet transmission time is assumed to be one unit. Flooding requires at least as many packet transmissions as the spanning tree method and usually many more. In this example, the time required for the broadcast packet to reach all nodes is the same for the two methods. In general, however, depending on the choice of the spanning tree, the time required for flooding may be less than for the spanning tree method. The spanning tree is used to avoid the looping of packets in the subnet.

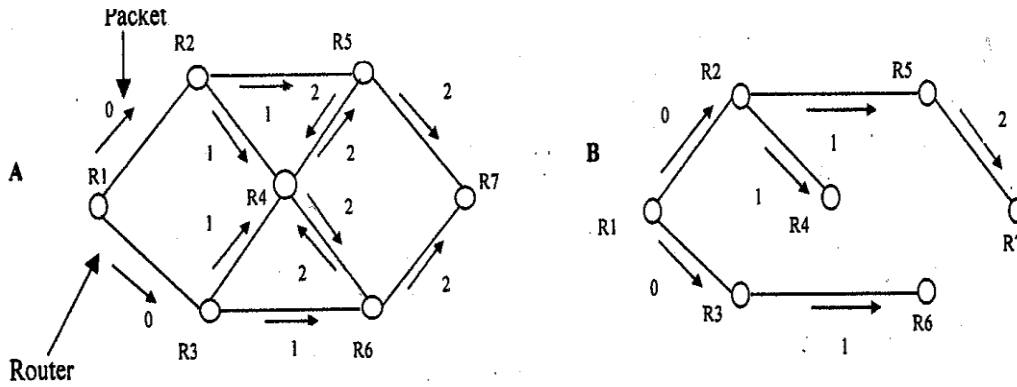

Figure 3.13(a): Flooding      Figure 3.13(b): Spanning Tree

Figure 3.13: Broadcasting (Source: Ref [2J])

Student should refer to [2] for further reading on this topic.



### SELF ASSESSMENT EXERCISE 7

1. Following statements are True or False
 

a	Dijkstra algorithm divides the node into two sets i.e., tentative and permanent.	T	F
b	Flooding generates lots of redundant packets.	T	F
c	Flooding discovers only the optimal routes	T	F
  
2. What is a spanning tree?

## 3.2 Shortest Path Routing Algorithm

Shortest path routing algorithm is a simple and easy to understand technique. The basic idea of this technique is to build a graph of the subnet, with each node of the graph representing a router and each arc of the graph representing a communication line i.e., link. For finding a route between a given pair of routers, the algorithm just finds the shortest path between them on the graph. The length of a path can be measured in a number of ways as on the basis of the number of hops, or on the basis of geographic distance etc.

There are a number of algorithms for computing the shortest path between two nodes of a graph. One of the most used algorithms is the **Dijkstra algorithm**. This is explained below:

### 3.2.1: Dijkstra Algorithm

In this algorithm, each node has a label which represents its distance from the source node along the best-known path. On the basis of these labels, the algorithm divides the node into two sets i.e., tentative and permanent. As in the beginning no paths are known, so all labels are tentative. The Algorithm works in the following manner:

- 1 First mark source node as current node (T -node)
- 2 Find all the neighbours of the T -node and make them tentative.
- 3 Now examine all these neighbours.
- 4 Then among all these node, label one node as permanent (i.e., node with the lowest weight would be labelled as permanent) and mark it as the T -node.
- 5 If, the designation node is reached or tentative list is empty then stop, else go to step 2.

An example of **Dijkstra** routing algorithm is explained in **Figure 3.14**: In this example, we want to find the best route between A and E. Here, we will show permanent nodes with filled circles and T -nodes with the --> symbol.

- 1 As shown in the Figure 3.14(a), the source node (A) has been chosen as T-node, and so its label is permanent.

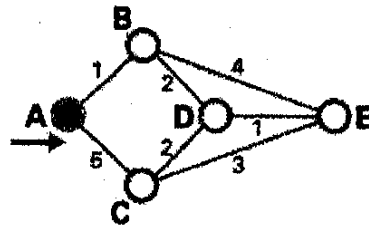

Figure 3.14(a) Dijkstra Algorithm A

- 2 In this step, as you see B, C are the tentative nodes directly linked to T -node (A). Among these nodes, since B has less weight, it has been chosen as T -node and its label has changed to permanent as shown in figure 3.14(b).

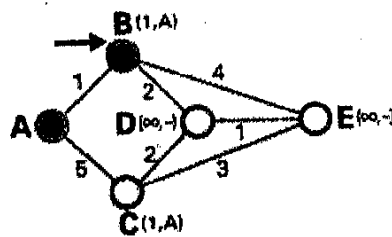

Figure 3.14(b) Dijkstra Algorithm b

- 3 In this step, as you see D, E are the tentative nodes directly linked to T -node (B). Among these nodes, since D has less weight, it has been chosen as T -node and its label has changed to permanent as displayed in figure 3.14(c).

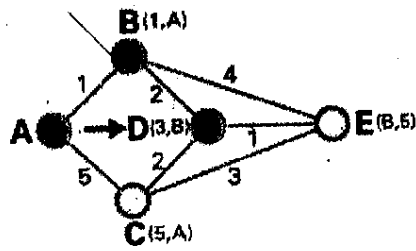

Figure 3.14 (c) Dijkstra Algorithm C

- 4 In this step, as you see C, E are the tentative nodes directly linked to T -node(D). Among these nodes, since E has less weight, it has been chosen as T -node and its label has changed to permanent as displayed in figure 3.14(d).

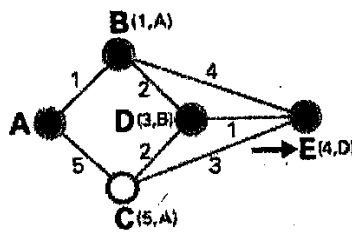

Figure 3.14 (d) Dijkstra Algorithm D

- 5 E is the destination node. Now, since the destination node (E) has been, reached so, we stop here, and the shortest path is A -B -D -E.

Figure 3.14: Dijkstra's algorithm to compute the shortest path routing

### 3.3 Distance Vector Routing

Nowadays, computer networks generally use dynamic routing algorithms rather than the static ones described above because, static algorithms do not take the current network load into account. **Distance vector routing** and **link state routing** are two main dynamic algorithms. In this section, we will go through the distance vector routing algorithm. It is also known as **Belman-Ford routing algorithm**.

#### Bellman-Ford Algorithm (Distance Vector Routing Algorithm)

The Bellman-Ford algorithm can be stated as follows: Find the shortest paths from a given source node subject keeping in mind the constraint that, the paths contain at most one link; then, find the shortest paths, keeping in mind a constraint of paths of at most two links, and so on. This algorithm also proceeds in stages. The description of the **Algorithm** is given below.

$s$  = source node  
 $w(i,j)$  = link cost from node  $i$  to node  $j$ ;  $w(i,j) = \infty$  if the two nodes are not directly connected;  $w(i,j) \geq 0$  if the two nodes are directly connected.

$h$  = maximum number of links in a path at the current stage of the algorithm

$L_h(n)$  = cost of the least-cost path from node  $s$  to node  $n$  under the constraint of no more than  $h$  links

**1. [Initialization]**

$$L_0(n) = \infty, \text{ for all } n \neq s$$

$$L_h(s) = 0, \text{ for all } h$$

**2. [Update]**

For each successive  $h \geq 0$ :

For each  $n \neq s$ , compute

$$L_{h+1}(n) = \min_j [L_h(j) + w(j,n)]$$

Connect  $n$  with the predecessor node  $j$  that achieves the minimum, and eliminate any connection of  $n$  with a different predecessor node formed during an earlier iteration. The path from  $s$  to  $n$  terminates with the link from  $j$  to  $n$  as shown in figure 3.15.

For the iteration of step 2 with  $h = K$ , and for each destination node  $n$ , the algorithm compares potential paths from  $s$  to  $n$  of length  $K + 1$  with the path that existed at the end of the previous iteration. If the previous, shorter path has less cost, then that path is retained. Otherwise a new path with length  $K + 1$  is defined from  $s$  to  $n$ ; this path consists of a path of length  $K$  from  $s$  to some node  $j$ , plus a direct hop from node  $j$  to node  $n$ . In this case, the path from  $s$  to  $j$  that is used is the  $K$ -hop path for  $j$  defined in the previous iteration.

Figure 3.16 shows the result of applying this algorithm to a public switched network, using  $s = 1$ . At each step, the least-cost paths with a maximum number of links equal to  $h$  are found. After the final iteration, the least-cost path to each node and the cost of that path has been developed. The same procedure can be used with node 2 as the source node, and so on. Students should apply Dijkstra's algorithm to this subnet and observe that the result will eventually be the same.

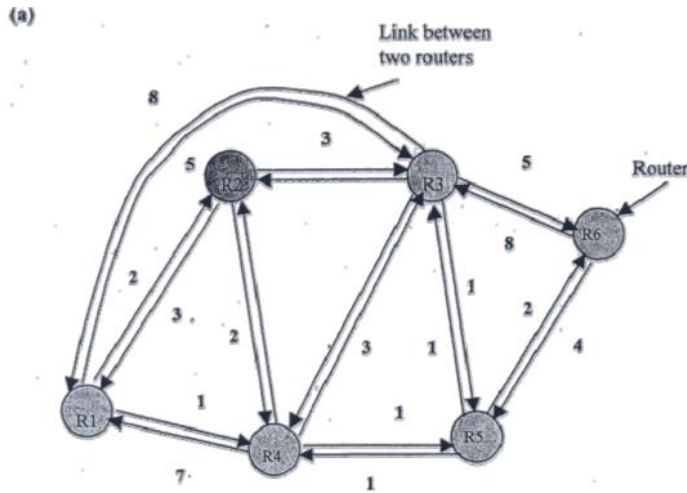

Figure 3.15: Public Switched Network

(b) Bellman-Ford Algorithm ( $s=1$ )

$H$	$L_h(2)$	Path	$L_h(3)$	Path	$L_h(4)$	Path	$L_h(5)$	Path	$L_h(6)$	Path
0	$\infty$	—	$\infty$	—	$\infty$	—	$\infty$	—	$\infty$	—
1	2	1-2	5	1-3	1	1-4	$\infty$	—	$\infty$	—
2	2	1-2	4	1-4-3	1	1-4	2	1-4-5	10	1-3-6
3	2	1-2	3	1-4-5-3	1	1-4	2	1-4-5	4	1-4-5-6
4	2	1-2	3	1-4-5-3	1	1-4	2	1-4-5	4	1-4-5-6

Figure 3.16: Link Cost (Ref. Source [3])

### 3.3.1 Comparison

Now, let us compare the two algorithms in terms of what information is required by each node to find out the optional path in the Bellman-Ford algorithm. In step 2, the calculation for node  $n$  involves knowledge of the link cost to all neighbouring nodes to node  $n$  [i.e.,  $w(j, n)$ ] plus the total path cost to each of those neighbouring nodes from a particular source node  $s$  (i.e.,  $L_h(j)$ ). Each node can maintain a set of costs and associated paths for every other node in the network and, exchange this information with its direct neighbours from time to time. Each node can therefore, use the expression in step 2 of the Bellman-Ford algorithm, based only on information from its neighbours and knowledge of its link costs, to update its costs and paths. On the other hand, consider Dijkstra's algorithm. Step 3, it appears, required that each node have complete topological information about the network. That is, each node must know the link costs of all links in the network. Thus, for this algorithm, information must be exchanged with all other nodes.

In general, an evaluation of the relative merits of the two algorithms should consider the processing time of the algorithms and the amount of information that must be collected from other nodes in the network or internet. The evaluation will depend on the implementation approach and the specific implementation.

A final point: Both algorithms are known to converge under static conditions of topology, and link costs and will converge to the same solution. If the link costs change over time the algorithm will attempt to catch up with these changes. However, if the link cost depends on traffic, which in turn depends on the routes chosen, then a feedback condition exists, that could result in instabilities.

### 3.3.2 The Count-to-Infinity Problem

One of the serious drawbacks of the Bellman-Food algorithm is that it quickly responds to a path with a shorter delay but, responds slowly to a path with a longer delay. This is also known as count to infinity problem. Consider a subnet in which a router, whose best route to destination  $X$  is large. If, on the next exchange neighbour,  $A$  suddenly reports a short delay to  $X$ , the router just switches over to using line  $A$  to send traffic to  $X$ . In one vector exchange, the good news is processed.

To see how fast good news propagates, consider the five-node (linear) subnet of the following figure. (Figure 3.17), where the delay metric is the number of hops. In the Figure 3.17 (a) there are five routers  $Ra$ ,  $Rb$ ,  $Rc$ ,  $Rd$  and  $Re$  linked to each other linearly. Suppose, a router  $Ra$  is down initially and all the other routers know this. In other words, they have all recorded the delay to  $Ra$  as infinity.

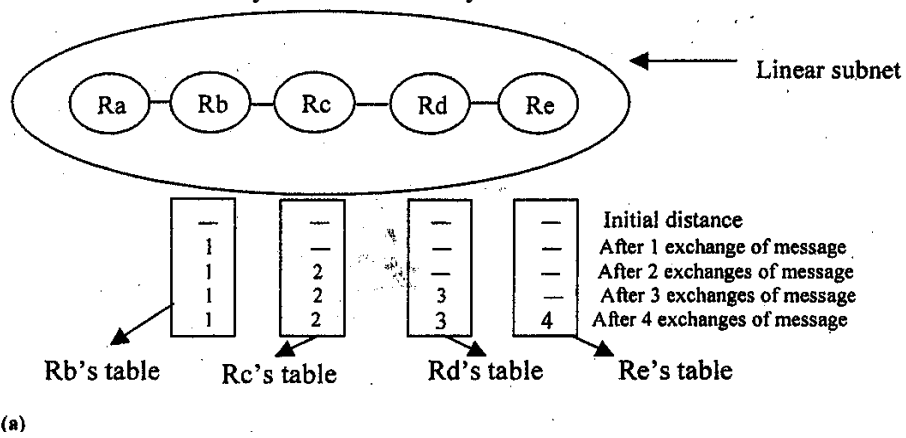

Figure 3.17(a): five node subnets

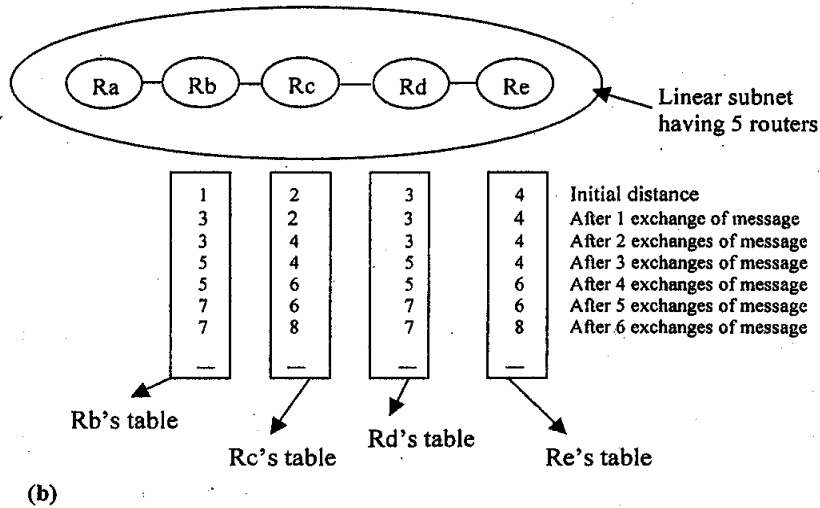

Figure 3.17 (b): Count to infinity problem

We will describe this problem in the following stages: (i) when router  $Ra$  is up, and (ii) when router  $Ra$  is down. Now let us take the first stage. When  $Ra$  is up, the other routers in the subnet learn about it via the information (vector) exchanges. At the time of the first exchange,  $Rb$  learns that its left neighbour has zero delay to  $Ra$ .  $Rb$  now makes an entry in its routing table that  $Ra$  is just one hop away to the left. All the other

routers still think that *Ra* is down. At this point, the routing table entries for *Ra* are as shown in the second row of [Figure 3.17\(b\)](#). On the next exchange, *Rc* learns that *Rb* has a path of length 1 to A, so it updates its routing table to indicate a path of length 2, but *Rd* and *Re* do not hear the good news until later. Clearly, the good news is spreading at the rate of one hop per exchange. In a subnet whose longest path is of length *N* hops, within *N* exchanges everyone will know about the newly-revived lines and routers.

Now, let us consider the second stage [Figure 3.17\(b\)](#), in which all the lines and routers are initially up. Routers *Rb* *Rc* *Rd* and *Re* are at a distance of 1,2,3 and 4 from A. Suddenly, A goes down, or alternatively, the line between A and B is cut, which is effectively the same thing from B's point of view.

At the first packet exchange, *Rb* does not hear anything from *Ra*. Fortunately, *Rc* says: Do not worry; I have a path to A of length 2. Little does B know that C's path runs through *Rb* itself. For all *Rb* knows, *Rc* might have ten lines all with separate paths to *Ra* of length 2. As a result, *Rb* thinks it can reach *Ra* via *Rc*, with a path length of 3. *Rd* and *Re* do not update their entries on the first exchange.

On the second exchange, C notices that each of its neighbours are claiming a path to *Ra* of length 3. It picks one of them at random and makes its new distance to *Ra* 4, as shown in the third row of [Figure 3.17\(b\)](#). Subsequent exchanges produce the history shown in the rest of [Figure 3.17\(b\)](#).

From [Figure 3.17](#), it should be clear why bad news travels slowly: no router ever has a value higher than the minimum of all its neighbours. Gradually, all routers work their way up to infinity, but the number of exchanges required depends on the numerical value used for, infinity. For this reason, it is wise to set infinity to the longest path plus 1. If the metric time is delay, there is no well-defined upper bound, so a high value is needed to prevent a path with a long delay from being treated as down. Not entirely surprisingly, this problem is known as the count-to-infinity problem. The core of the problem is that when X tells Y that it has a path somewhere, Y has no way of knowing whether it itself is on the path.

### 3.4 Link State Routing

As explained above distance vector routing algorithm has a number of problems like count to infinity problem. For these reasons, it was replaced by a new algorithm, known as the link state routing.

Link state routing protocols are like a road map. A link state router cannot be fooled as easily into making bad routing decisions, because it has a complete picture of the network. The reason is that, unlike approximation approach of distance vector, link state routers have first hand information from all their peer routers. Each router originates information about itself, its directly connected links, and the state of those links. This information is passed around from router to router, each router making a copy of it, but never changing it. Link-state involves each router building up the complete topology of the entire network (or at least of the partition on which the router is situated), thus, each router contains the same information. With this method, routers only send information to all the other routers when there is a change in the topology of the network. The ultimate objective is that every router should have identical information about the network, and each router



should be able to calculate its own best path independently. Independently calculate its own best paths.

In contrast to the distance-vector routing protocol, which works by sharing its knowledge of the entire network with its neighbours, link-state routing works by having the routers inform every router in the network about its nearest neighbours. The entire routing table is not distributed any router but, the part of the table containing its neighbours is:

Link-state is also known as shortest path first.

### Link State Packet

When a router floods the network with information about its neighbourhood, it is said to be advertising. The basis of this advertising is a short packet called a link state packet (LSP). An LSP usually contains four fields: the ID of the advertiser, the ID of the destination network, the cost, and the ID of the neighbour router. The structure of a LSP is shown in [Figure 3.18](#).

Advertiser DD	Network DD	Cost	Neighbour DD
.....	.....	.....	.....
.....	.....	.....	.....

Figure 3.18: Link State Packet (LSP)

### How Link State Routing Operates

The idea behind link state routing is simple and can be stated in five parts as suggested by Tanenbaum [Ref. I]. Each router must do the following:

#### 1 Neighbour discovery

The Router has to discover its neighbours and learn their network addresses. As a router is booted, its first task is to learn who its neighbours are.

The Router does this by sending a special HELLO packet on each point-to-point line. The router on the other end is expected to send a reply disclosing its identity. These names must be globally unique. If two or more routers are connected by a LAN, the situation becomes slightly more complicated one way of modelling the LAN is to consider it as a node itself. Please see reference [I] for further explanation through a diagram.

#### 2 Measure delay

Another job that a router needs to perform is to measure the delay or cost to each of its neighbours. The most common way to determine this delay is to send over the line a special ECHO packet that the other side is required to send back immediately. By measuring the round-trip time and dividing it by two, the sending router can get a reasonable estimate of the delay. For even better results, the test can be conducted several times and the average used.

This method implicitly assumes that delays are symmetric, which may not always be the case.

### 3 Building link state packets

After collecting the information needed for the exchange, the next step for each router is to build a link state packet containing all the data. This packet starts with the identity of the sender, followed by a sequence number and age, and a list of neighbours. For each neighbour, the delay to that neighbour is given.

As an example, let's consider the subnet given in [Figure 3.19](#) with delays shown as labels on the lines. For this network, the corresponding link state packets for all six routers are shown in the [figure 3.20](#).

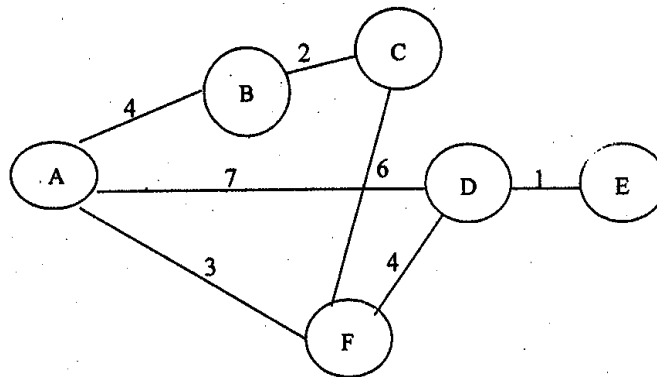

Figure 3.19: A subnet for link state routing

A		B		C		D		E		F	
Seq.		Seq.		Seq.		Seq.		Seq.		Seq.	
Age		Age		Age		Age		Age		Age	
B	4	C	2	B	2	A	7	D	1	A	3
D	7	A	4	F	6	E	1			C	4
F	3					F	4			D	6

Figure 3.20: The link state packets (LSPs) for the subnet in figure

Building the link state packets is easy. The hard part is determining when to build them. One possibility, is to build them periodically, that is, at regular intervals. Another possibility is to build them when some significant event occurs, such as a line or neighbour going down or coming back up again or changing its properties appreciably.

#### 1 Distribute the packets

Let us describe the basic algorithm in distributing the link state packet. The fundamental concept here is flooding to distribute the packets. But to keep the number of packets flowing in the subnet under control, each packet contains a sequence number that is incremented for each new packet delivered. When a new link state packet arrives, it is

checked against the list of packets already seen by a router. It is discarded in case the packet is old; otherwise it is forwarded on all lines except the one it arrived on. A router discards an obsolete packet (i.e., with a lower sequence) in case it has seen the packet with a highest sequence number.

The age of a data packet is used to prevent corruption of the sequence number from causing valid data to be ignored. The age field is decremented once per second by the routers which forward the packet. When it hits zero it is discarded. How often should data be exchanged?

## 2 Compute shortest path tree

After accumulating all link state packets, a router can construct the entire subnet graph because every link is represented. In fact, every link is represented twice, once for each direction. The two values can be averaged or used separately.

Now, an algorithm like Dijkstra's algorithm can be run locally to construct the shortest path to all possible destinations. The results of this algorithm can be installed in the routing tables, and normal operation resumed.

### Problems in Link State Routing

In link state protocol, the memory required to store the data is proportional to  $k * n$ , for  $n$  routers each with  $k$  neighbours and the time required to compute can also be large.

In it bad data e.g., data from routers in error will corrupt the computation.

## 3.5 Hierarchical Routing

As you see, in both link state and distance vector algorithms, every router has to save some information about other routers. When the network size grows, the number of routers in the network increases. Consequently, the size of routing tables increases, as well, and routers cannot handle network traffic as efficiently. We use hierarchical routing to overcome this problem. Let's examine this subject with an example:

We use distance vector algorithms to find best routers between nodes. In the situation depicted below in [Figure 3.22](#), every node of the network has to save a routing table with 17 records.

Here is a typical graph and routing table ([Table 3.21](#)) for A:

Destination	Line	Weight
A	---	---
B	B	1
C	C	1
D	B	2
E	B	3
F	B	3
G	B	4
H	B	5
I	C	5
J	C	6
K	C	5
L	C	4
M	C	4
N	C	3
O	C	4
P	C	2
Q	C	3

Figure 3.21: typical graph and routing table

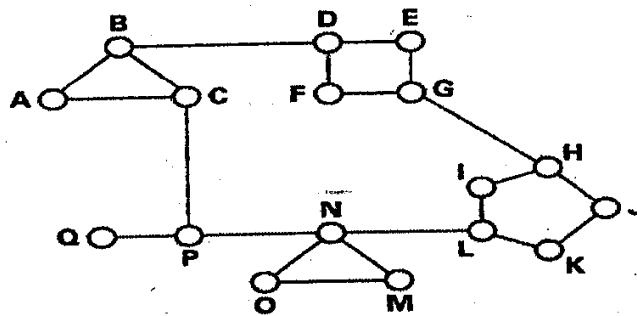

Figure 3.22: Network graph

In hierarchical routing, routers are classified in groups known as *regions* (Figure 3.23). Each router has only the information about the routers in its own region and has no information about routers in other regions. So, routers just save one record in their table for every other region. In this example, we have classified our network into five regions as shown Figure 3.24.

Destination	Line	Weight
A	---	---
B	B	1
C	C	1
Region 2	B	2
Region 3	C	2
Region 4	C	3
Region 5	C	4

Figure 3.23: A's Routing table for Hierarchical! Routing

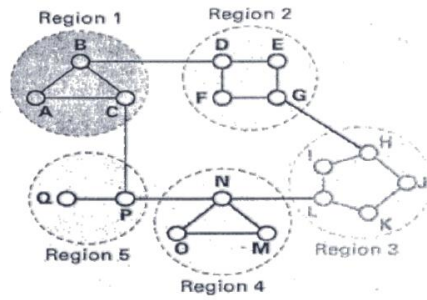

Figure 3.24: Hierarchical routing

If A wants to send packets to any router in region 2 (D, E, F or G), it sends them to B, and so on. As you can see, in this type of routing, the tables sizes are reduced so, network efficiency improves. The above example shows two-level hierarchical routing. We can also use three or four level hierarchical routing as well.

In three-level hierarchical routing, the network is classified into a number of clusters. Each cluster is made up of a number of regions, and each region contains a number of routers. Hierarchical routing is widely used in Internet routing and makes use of several routing protocols.

### 3.6 Broadcast Routing

Up to now we were discussing about sending message from a source to a destination. Sometimes a host needs to send messages to all other hosts. This type of transmission i.e., to send a message to all destinations simultaneously is known as *broadcasting*. There are a number of methods for broadcasting. These are:

#### 1. Send /I distinct packet to each destination

This is a very simple method, in which a source sends a distinct packet to each destination. Major disadvantages of this method are:

- a. It wastes bandwidth.
- b. In this method source needs to have a complete list of all destinations.

Because of this reason this method is the least desirable of the other methods.

#### 2. Flooding

This is also a very simple method of broadcasting. In this method every incoming packet is sent out on every outgoing line except the line from which it arrived. This algorithm is very simple to implement. But the major disadvantage of this algorithm is that it generates lots of redundant packets, thus consumes too much bandwidth.

#### 3. Multi-destination routing

In this method each packet contains either a list of destinations or a bit map indicating the desired destinations. When a packet arrives at a router, router determines the set of output lines that would be required by checking all the destinations. Router only chooses those output lines which are the best route to at least one of the destinations. After this router creates a new copy of the packet for each output line to be used and in each packet, it includes only those destinations that are to use the line. Therefore, the destination set is partitioned among the output lines. In this, after a sufficient number of hops, each packet will carry only one destination and can be treated as a normal packet.

#### **4. Using a Spanning Tree**

A spanning tree is a subset of graph that includes all the nodes (of graph) but contains no loops. This method uses the spanning tree; therefore, each router knows which of its lines belong to the spanning tree. When a packet arrives at a router, it copies onto all the spanning tree lines except the one it arrived on. Advantage of this method is that it makes excellent use of bandwidth and generates only the minimum number of packets required to do the job.

In this method each router must have knowledge of some spanning tree. Sometimes this information is available (e.g., with link state routing) but sometimes it is not (e.g., with distance vector routing), this is the major disadvantage of this method.

#### **5. Reverse path forwarding**

Our last broadcast algorithm is an attempt to approximate the behaviour of the previous one, even when the routers do not know anything at all about spanning trees. The idea, called reverse path forwarding, is remarkably simple once it has been pointed out.

In this method, when a broadcast packet arrives at a router, the router checks whether the packet arrived on the line that is normally used for sending packets to the source of the broadcast or not.

*If* the packet arrived on the line that is normally used for sending packets to the source of the broadcast then Router forwards copies of it onto all lines except the one it arrived on.

*Else* (i.e., packet arrived on a line other than the preferred one for reaching the source)

Router discards the packet as a likely duplicate.

### 3.7 Multicast Routing

In many cases, you need to send same data to multiple clients at the same time. In this case, if, we use unicasting then the server will connect to each of its clients again and again, but each time it will send an identical data stream to each client. This is a waste of both server and network capacity. If, we use broadcasting in this case, it would be inefficient because sometimes receivers are not interested in the message but they receive it nonetheless, or sometimes they are interested but are not supposed to see the message.

In such cases i.e., for sending a message to a group of users (clients), we use another technique known as multicasting. The routing algorithm used for multicasting, is called multicast routing.

Group management is the heart of multicasting. for group management, we require some methods to create and destroy a group and to allow processes to join and leave a group. When a router joins a group, it informs its host of this fact. For routing, routers mainly want to know which of their hosts belong to which group. For this, either the host must inform their router about changes in the group membership, or routers must query their hosts periodically. On receiving this information, routers tell their neighbours, so the **information** propagated through the subnet.

Now, we will learn the working of multicasting through an example. In our example (as shown in Figure 3.25), we have taken a network containing two groups i.e., group 1 and 2. Here, some routers are attached to hosts that belong to only one of these groups and some routers are attached to hosts that belong to both of these groups.

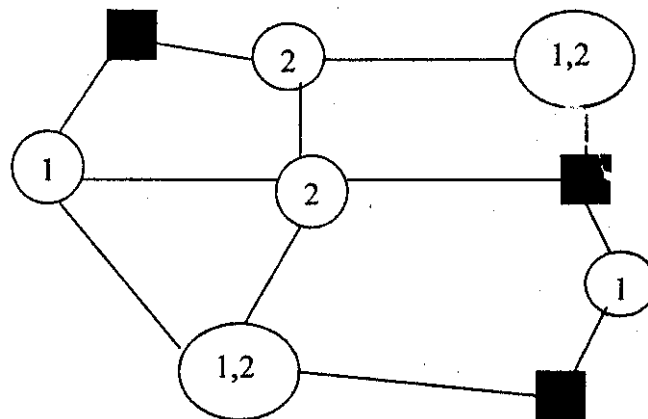

Figure 3.25: Network containing two groups i.e., 1 and 2

To do multicast routing, first, each router computes a spanning tree covering all other routers. For example, Figure 3.26 shows spanning tree for the leftmost router.

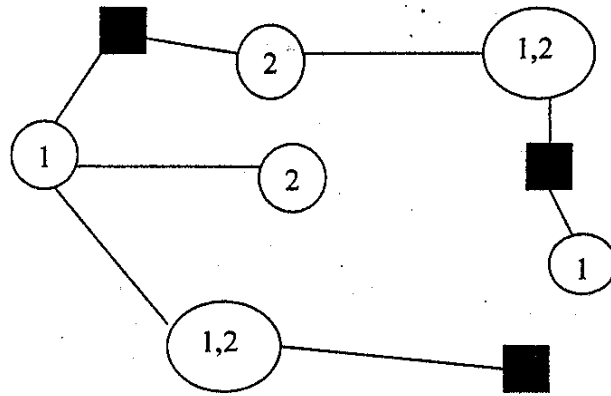

Figure 3.26: Spanning tree for the leftmost router

Now, when a process sends a multicast packet to a group, the first router examines its spanning tree and prunes it. *Pruning* is the task of removing all lines that do not lead to hosts that are members of the group. For example, Figure 3.27 shows the pruned spanning tree for group 1 and Figure 3.28 shows the pruned spanning tree for group 2. There are a number of ways of pruning the spanning tree. One of the simplest ones that can be used, if link state routing is used and each router is aware of the complete topology, including the hosts that belong to those groups. Then, the spanning tree can be pruned, starting at the end of each path, working toward the root, and removing all routers that do not belong to the group under consideration. With distance vector routing, a different pruning strategy can be followed. The basic algorithm is reverse path forwarding. However, whenever a router with no hosts interested in a particular group and no connections to other routers, receives a multicast message for that group, it responds with a PRUNE message, thus, telling the sender not to send it any more multicasts for that group. When a router with no group members among its own hosts has received such a message on its lines, it, too, can respond with a PRUNE message.

In this way, the subnet is recursively pruned.

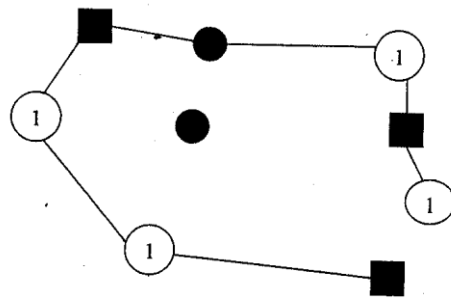

Figure 3.27: A pruned spanning multicast tree for group 1

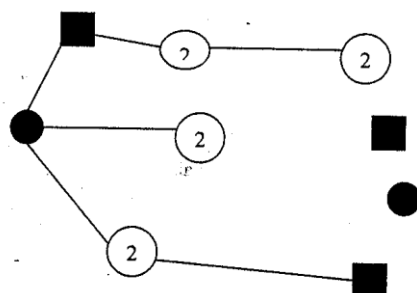



Figure 3.28: A pruned spanning multicast tree for group 2

After pruning, multicast packets are forwarded only along the appropriate spanning tree. This algorithm needs to store separate pruned spanning tree for each member of each group. Therefore, this would not be good for large networks.



#### 4.0 CONCLUSION

In this unit, you have learnt about routing algorithms like broadcasting and flooding. You have also learnt about the shortest path routing, distance vector costing.



#### 5.0 SUMMARY

In this unit, we first studied different routing algorithms. First, we looked at finding the route between a given pair of routers. The algorithm finds the shortest path between them on the graph. A number of algorithms for computing the shortest path between two nodes of a graph are known. Here, we have studied the Dijkstra algorithm.

Next, we studied flooding. In flooding, every incoming packet is sent out on every outgoing line except the line from which it arrived. This algorithm is very simple to implement, but it generates lots of redundant packets. It discovers all routes, including the optimal one, therefore this is robust and gives high performance.

Next, we studied the Belman-Ford routing algorithm. In this algorithm each host maintains a routing table. This routing table has an entry for every other router in the subnet. These tables are updated by exchanging information with the neighbours.

Next, we studied the link state routing algorithm. In this algorithm, each router originates information about itself, its directly connected links, and the state of those links. This information is passed around from router to router, each router making a copy of it, but never changing it. The ultimate objective is that every router has identical information about the network, and each router will independently calculate its own best paths.

Next, we discussed hierarchical routing algorithm. In hierarchical routing, routers are classified in groups known as regions. Each router has only the information about the routers in its own region and has no information about routers in other regions.

Next, we studied broadcasting i.e., the send a message to all destinations in a network simultaneously. There are a number of methods for broadcasting such as, flooding, multidestination routing, reverse path forwarding etc. In this unit we discussed all these methods in brief.

Finally, we discussed multicasting i.e., to send a message to a group of users in a network. In multicasting, each router first computes a spanning tree covering all other router. Now, when a process sends a multicast packet to a group, the first router examines its spanning tree and prunes it. Then, packets are forwarded only along the appropriate spanning tree.



## 6.0 TUTOR MARKED ASSIGNMENT 10

1. Which of the following statements are True or False?

- (i) Distance vector routing is a static routing algorithm. **True or False**
- (ii) Dijkstra's algorithms can **be** run locally in link state routing to construct the shortest path. **True False.**

2. Answer the following questions briefly.

- (i) What are the problems with distance vector routing algorithm?
- (ii) What is LSP?

3. Which of the following statements are True or False?

- (i) In hierarchical routing, each router has no information about routers in other regions. **True or False**
- (ii) A spanning tree is a subset of a graph that includes some of the nodes of that graph. **True or False**
- (iii) Sending a message to a group of users in a network is known as broadcasting. **True or False**

4. Answer the following questions in brief.

- (i) Explain reverse path forwarding in brief.
- (ii) What is Pruning?



## 7.0 REFERENCES/FURTHER READINGS

S. Tanenbaum, (2011). *Computer Network*, 4<sup>th</sup> edition, Prentice Hall of India, New Delhi.

Dmitri Bertekas and Robert Galleger, (1997). *Data Network*. Second edition, Prentice Hall of India, New Delhi.

William Stalling, *Data and Computer Communication*. Pearson Education, 2<sup>nd</sup> Edition, Delhi, 2003.

## 8.0 ANSWERS TO TUTOR MARKED ASSIGNMENT 10

### Question 1

Which of the following statements are True or False?

- (i) Distance vector routing is a static routing algorithm. T O F O

**False**

(ii) Dijkstra's algorithms can be run locally in link state routing to construct the shortest path. TO F 0

**True**

### Question 2

Answer the following questions briefly.

(i) What are the problems with distance vector routing (DVR) algorithm?

The problem with DVR is routing loop which causes count to infinity. This takes place when any interface goes down or two-**routers** send updates at the same time

(ii) What is LSP?

Link State Packet is a packet of information generated by a network router in a link state routing protocol that lists the router's neighbours. Link state packet can also be further defined as special datagrams that determine the names of and the cost or distance to any neighbouring routers and associated networks.

### Question 3

Which of the following statements are True or False?

(i) In hierarchical routing, each router has no information about routers in other regions. TO FO

**True**

(ii) A spanning tree is a subset of a graph that includes some of the nodes of that graph. TO FO

**True**

(iii) Sending a message to a group of users in a network is known as broadcasting. TO F 0

**False**

### Question 4

Answer the following questions in brief.

(i) Explain reverse path forwarding in brief.

Reverse path forwarding (RPF) is a technique in multicast routing that assists to guide against IP address spoofing and other kinds of problems. This technique is known as reverse path forwarding since in place of perceiving forward, the technique managing packet path will view back to check the reverse path of the packet

(ii) What is Pruning?

The path **pruning algorithm** finds **routing** shortcuts by exploiting the channel listening capability of wireless nodes, and is able to reduce a large number of hops with the help of a little state information passively maintained by a subset of nodes on the **route**.

## 9.0 ANSWERS TO SELF-ASSESSMENT 7

### Question 1

Check whether the following statements are True or False

(i) Dijkstra algorithm divides the node into two sets i.e., tentative and permanent. T F

Answer: False

(ii) Flooding generates lots of redundant packets. T F

Answer: True

(iii) Flooding discovers only the optimal routes T F

Answer: False

### Question 2

What is a spanning tree?

### Solution

Taking for example, an extended LAN as being substituted by a graph that probably has loops (cycles), then a spanning tree is a subgraph of this graph that covers (spans) all the vertices but contains no cycles. That is, a spanning tree retains all of the vertices of the original graph but throws out some of the edges.

## UNIT 3 CONGESTION CONTROL IN PUBLIC SWITCHED NETWORK

### CONTENTS

- 1.0 Introduction
- 2.0 Objectives
- 3.0 Main Content
  - 3.1 Reasons for Congestion in the network
  - 3.2 Congestion Control vs. Flow Control
  - 3.3 Congestion Prevention Mechanism
  - 3.4 General Principles of Congestion Control
  - 3.5 Open Loop Control
    - 3.5.1 Admission Control
    - 3.5.2 Traffic Policing and its Implementation
    - 3.5.3 Traffic Shaping and its Implementation
  - 3.5.4 Difference between Leaky Bucket Traffic Shaper and Token Bucket Traffic Shaper
  - 3.6 Congestion Control in Packet-switched Networks

- 4.0 Conclusion
- 5.0 Summary
- 6.0 Tutor-Marked Assignment
- 7.0 References/Further Readings



## 1.0 INTRODUCTION

Congestion occurs when the number of packets being transmitted through the public switched networks approaches the packet handling capacity of the network. When the number of packets dumped into the subnet by the hosts, is within its carrying capacity, all packets are delivered (except for a few that are afflicted with transmission errors). The networks get overloaded and start dropping the packet, which leads to congestion in the network. Due to the dropping of packets, the destination machine may demand the sources to retransmit the packet, which will result in more packets in the network and this leads to further congestion. The net result is that the throughput of the network will be very low as, illustrated in the [Figure 3.29](#).

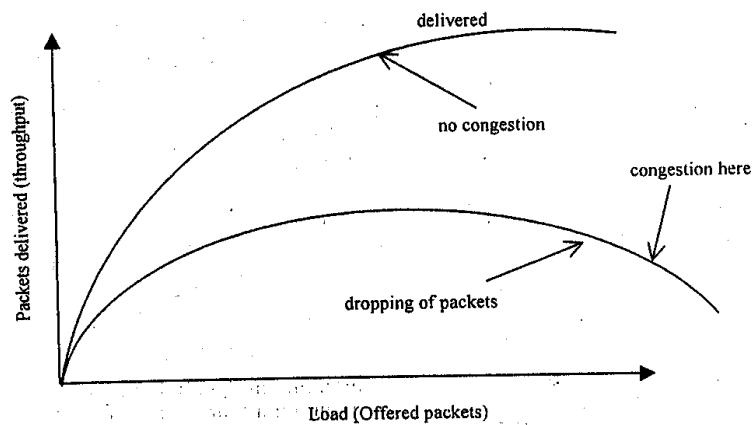

**Figure 3.29: Congestion in Network**



## 2.0 OBJECTIVES

After going through this unit, you should be able to:

- 1 define congestion
- 2 list the factors for the occurrence of congestion in the Network
- 3 differentiate between congestion control and flow control
- 4 outline the general principles of congestion Control
- 5 discuss congestion prevention mechanism.



## 3.0 MAIN CONTENT

### 3.1 Reasons for Congestion in the Network

**Tanenbaum** [Ref 1] has **listed** several reasons for the occurrence of congestion in the network:

- 1 Sudden arrival of a packet on a particular output line from multiple input source, leading to the formation of a queue and dropping of a packet in case of an insufficient memory in a router to hold these packets. Nagle has pointed out that, even if, there is a huge memory at the router level, there is no improvement in congestion, rather, it get worse because of time out of the packet.
- 2 Slow processors can also cause congestion.
- 3 Low bandwidth channels can also cause congestion. If, we increase the bandwidth without a fast processor or vice-versa, will be of little help.

### 3.2 Congestion Control Vs Flow Control

The differences between congestion and flow control are whether mentioning as they are related terms. There is another term, related to these two, called **error control**. **Congestion Control** ensures that the subnet is able to carry the offered traffic and that it is not overloaded. **Flow control** has to do with ensuring that the fast sender does not overload packets from the noisy channels receiver. Error control deals with algorithms that recover or conceal the effects from packet losses. The goal of each of these control mechanisms are different, but, the implementation can be combined.

Figure 3.30 differentiates between Congestion Control and Flow Control:

Congestion Control	Flow Control
Congestion Control is needed when buffers in packet switches overflow or cause congestion.	Flow Control is needed when, the buffers at the receiver are not depleted as fast as the data arrives.
Congestion is end-to-end, it includes all hosts, links and routers. It is a global issue.	Flow is between one data sender and one receiver. It can be done on link-to-link or end-to-end basis. It is a local issue.
If viewed as a "congested buffer", then the switch tells the source of the data stream to slow down using congestion control notifications. When output buffers at a switch fill up and packets are dropped this leads to congestion control actions.	If there is a queue on the input side of a switch, and link-by-link flow control is used, then as a "flow control" action the switch tells its immediate neighbour to slow down if the input queue fills up.

Figure 3.30: Congestion Control vs. Flow Control

The reason for comparing congestion and flow control is that, some congestion control algorithms operate by sending messages back to the senders to slow down incase, the network is congested. In case, the receiver is overloaded, the host will get a similar message to slow down.

### 3.3 Congestion Prevention Mechanism

The purpose of this section is to examine various mechanisms used at the different layers to achieve different goals. But, from the congestion control point of view, these mechanisms are not very effective. We will start with data link layer first. **Go back N** and **Selection Repeat** are flow control mechanism available at the data link layer. In case, there is any error with the packet, **Go back N** retransmits all the packets up to the packet where the error occurred. For example, there is an error in 5<sup>th</sup> packet, it means that it will retransmit 1,2,3,4, and 5 which create extra load on the network, thereby, leading to congestion. **Selective repeat** retransmits only that packet. With respect to congestion control, selective repeat is clearly better than go back N.

Figure 3.31 provides the detail:

Layer	Mechanisms	Solution
Transport	<ul style="list-style-type: none"> <li>Sliding window with credit schemes</li> <li>Piggybacking</li> <li>Timeout determination</li> </ul>	Similar to data link layer problem + Optimal time out determination
Network	<ul style="list-style-type: none"> <li>Bad Routing algorithm</li> <li>Packet lifetime management</li> </ul>	A good routing algorithm + Optimal lifetime manager
Data link layer	<ul style="list-style-type: none"> <li>Go back N, Selective Repeat</li> <li>Piggybacking</li> </ul>	Selective Repeat + Small window size.

Table 3.31: Mechanism Affecting Congestion

**Acknowledgement mechanism** also affects congestion. If, each packet is acknowledged immediately then it will generate extra traffic. However, if acknowledgement is piggybacked onto reverse traffic along, extra timeouts and retransmissions may happen which will cause congestion. **A flow control scheme with a small window size reduces the data rate and thus, helps reduce congestion.**

At the network good routing algorithm can help avoid congestion by distributing the traffic over all the lines, whereas a bad one can send too much traffic over already congested lines. Finally, packet lifetime management deals with the duration a packet may live before being discarded. If, it is too long, lost packets may reside in the network a long time, but if, it is too short, packets may sometimes time out before reaching their destination, thus, inducing retransmissions. Therefore, we require good routing algorithm and optimal packet life time.

Between transport and data link layer there are common issues (Flow Control, acknowledge mechanism) with respect to Congestion Control mechanism but at the transport layer, the extra problem is related to determining time out internal across the network, which is a difficult problem.

### 3.4 General Principles of Congestion Control

From our earlier discussions it appears that congestion problem is not very easy to solve. Typically, the solution depends on the type of requirements for the application (e.g., QoS,

high bandwidth, fast processing). Like routing algorithm, congestion control algorithms have been classified into two types:

- 1 Open Loop
- 2 Closed Loop.

**Open loop** solutions attempt to solve the problem with a good design, that ensures that congestion does not occur in the network. Once having network is running midcourse corrections are not made. Open loop algorithm works on two basic mechanisms: i) **Admission Control** ii) **Resource Reservation**. Admission control is a function performed by a network to accept or reject traffic flow. Therefore, the purpose of open loop solution is to ensure that the traffic generated by the source will not lower the performance of network below the specified QoS. The network will accept traffic till QoS parameters are satisfied otherwise, it rejects the traffic.

In contrast, **closed loop** solutions are based on the concept of a feedback loop. These algorithms are called closed loop because the state of the network has to be fed up to the source that regulates traffic. Closed loop algorithms follow dynamic approach to the solution of congestion problems. It reacts during the congestion occurrence period or when the congestion is about to happen. A variety of metrics have been proposed to monitor the state of a subnet in order to observe congestion. These are:

- 1 Queue length
- 2 The number of retransmitted packets due to timeout
- 3 Percentage of rejected packets due to shortage of the router's memory
- 4 Average packet delay.

To prevent congestion from occurring, this mechanism monitors the system to detect when and where congestion occurs, pass is this information to places **where** action can be taken usually at the source and finally adjusts the systems operation to correct the problem.

The presence of congestion means that the offered load in the network is (temporarily) greater than the resources (routers) can handle. Two straight forward solutions are to **increase the resources or decrease the load**. To increase the resources the following mechanism may be used as suggested in *Tanenbaum [Ref 1]*.

- 1 Higher bandwidth may be achieved by increasing transmission power of a satellite.
- 2 Splitting traffic on multiple routers instead of a single best rout.
- 3 Use of temporary dial-up telephone line between certain points.

However, sometimes it is not possible to increase the capacity or it has already been increased to the limit. But, if the network has reached the maximum limit, the alternative is to reduce the load. The following mechanism may be used (i) Denying service to some users (ii) Degrading services to some or all users.

For subnets that use virtual circuits internally, these methods can be used at the network layer. In the next section, we will focus on their use in the network layer.



We will also discuss the open loop control mechanism in detail. The closed loop mechanism will be discussed in Block 4 Unit 2 as a part of TCP Protocol.

### 3.5 Open Loop Control

As **discussed** earlier, Open Loop Control algorithm prevent the occurrence of Congestion occurrence rather than dealing with it after it has occurred. It does not rely on feedback information to regulate the traffic. Thus, this technique is based on the assumption that once the packets are accepted from a particular source, the network will not get overloaded. In this section, we will examine several such techniques and its implementation. Learners are requested to **Leon Garcia's** book [Ref 2].

#### 3.5.1 Admission Control

This is a widely used technique in virtual circuit network. The technique is very simple and straight forward. Once congestion has occurred, no more virtual circuits are to be set up. This is similar to a telephone system in which there is no dial tone in case the source gets overloaded. When a source wants to establish a connection, admission control mechanism examines QoS parameters of the connections initiated by the source. If it is OK, the connection (YC) is established otherwise, it is rejected. In order to initiate a connection setup, a source specifies its traffic flow indicating a set of parameters called **traffic descriptor**, which includes **peak rate**, **average rate**, and **maximum traffic burst size**. (Maximum length of time the traffic is generated at the peak rate) and so on. Based on the characteristic of traffic flow, admission control mechanism reserves the bandwidth (which usually lies between peak rate and average rate).

#### 3.5.2 Traffic Policing and its Implementation

Leon Garcia [Ref2] has defined traffic policing as the process of monitoring and enforcing the traffic flow of packets during the connection period. The network may drop or mark the packet as noncompliant and give low priority to traffic in case, it does not obey the agreed upon parameters values during the initial connection setup phase. Most implementations of traffic policing is done through the Leaky Bucket algorithm. In this algorithm the bucket is considered as a network and traffic flow is considered as water being poured into a bucket. The following assumptions are made:

- 1 The bucket has certain depth to hold water just like a network can accept a certain number of packets.
- 2 The bucket leaks at a certain rate (if there is water in the bucket) no matter at what rate water enters the bucket. In terms of computer networks, it should be interpreted as follows: No matter at what rate the packets arrive at the input lines of a routers, routers in a subnet passes to its outgoing link at a fixed rate.
- 3 If the bucket does not overflow when the water is poured into the bucket, then the bucket of water is said to be conforming. In terms of network, if the traffic is within the agreed norms, all packets will be transferred.

- 4 The bucket will spill over if, it is full and if, additional water is poured into it, if it gets more packets than it can handle, it will lead to congestion and then the network due to which the additional packets will be lost.

If, we expect the traffic flow to be very smooth, then the bucket has to be of a shallow type. In case, the flow is busty in nature, the bucket should be deeper. In summary, what we want to observe is whether the outflow of packets corresponds to the arrival rate of packets or not? Implementation of a leaky bucket is similar to queue data structure implementation. When a packet arrives, if there is space left in the queue, it gets appended to the queue otherwise, it gets rejected.

### 3.5.3 Traffic Shaping and its Implementation

**Leon Garcia [Ref2]** defined traffic shaping as the process of altering traffic flow to another flow. It is mainly used for smoothening the traffic. Consider an example, where a host is generating data at 30 kbps, which, it can transmit to the network in several ways (as shown in the following **Figure 3.32**).

It can transmit at the rate of 100 kbps for 0.3 Second  
It can transmit at the rate of 75 kbps for 0.4 Second

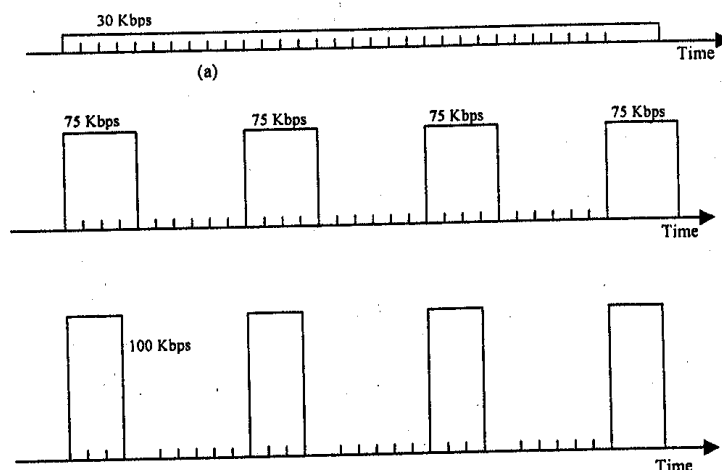

**Figure 3.32: Possible traffic patterns at the average rate of 30 Kbps**

You can make observation from the **Figure 3.32** that the **Figure 3.32(a)** shows the smoothened pattern will create less stress on the network but the destination machine may not want to wait for 1 Second to retrieve 30 kbps data at each period. Now, we will look at its implementation. There are two mechanisms:

- 1 Leaky bucket traffic Shaper
- 2 Token bucket traffic Shapero

#### Leaky Bucket Traffic Shaper

It is a very simple mechanism in which data stored at the senders buffer, is passed on at a constant interval to smoothen traffic as shown in **Figure 3.33**. The buffer is used to store busty traffic. This size defines the maximum burst that can be accommodated.

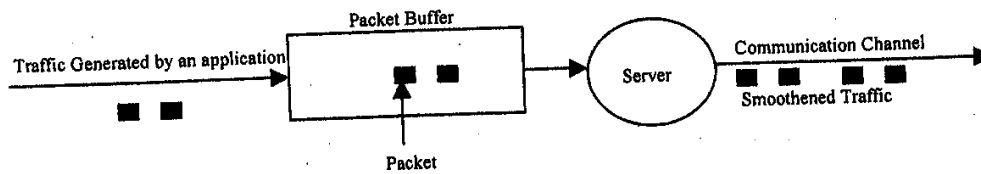

Figure 3.33: A leaky bucket traffic shaper

This mechanism is different from a leaky bucket algorithm which was used in traffic policing. The bucket in traffic policing is just a counter whereas, a bucket in traffic shaper is a buffer that stores the packets.

### Token Bucket Traffic Shaper

The leaky bucket traffic shaper has a very restricted approach. Since, the output pattern is always constant no matter how busy traffic is. Many applications produce variable rate traffic; sometimes busy but sometimes normal. If, such traffic is allowed to pass through a leaky bucket traffic shaper, it may cause a very long delay. One such algorithm that deals with such situations is the **token bucket algorithm**.

The following are the features of token bucket traffic shaper:

- 1 Token is used here, as a permit to send a packet. Unless there is a token, no packet can be transmitted.
- 2 A Token bucket holds tokens which are generated periodically at a constant rate.

New tokens are discarded, in case, the token buckets are full.

A packet can be transmitted only if, there is a token in the token buffer. For example; in the [Figure 3.34](#) there are two tokens in the token buffer and five packets to be transmitted. Only two packets will be transmitted and the other three will wait for tokens.

Traffic burstiness is proportional to the size of a token bucket. Now, let us discuss the operation of this algorithm;

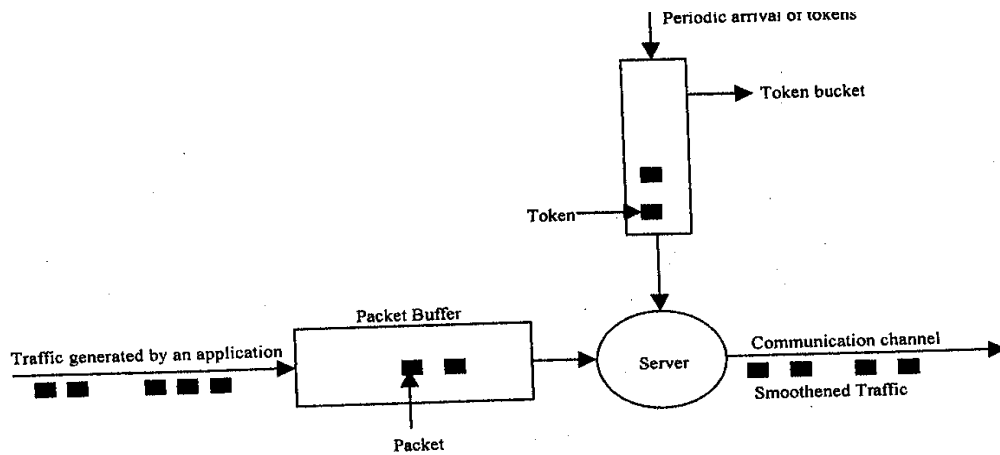

Source: Ref.[2]

Figure 3.34: Token bucket traffic shaper

Just assume that the token bucket is empty and the numbers of packets have arrived in the buffer. Since, there is no token in the token buffer, the packets have to wait until the new packet is generated. Since, tokens are generated periodically, the packet will be also transmitted periodically at the rate at which the tokens arrive. In, the next section, we will compare between the leaky bucket traffic shaper and token bucket traffic shaper. Students are also requested to see question 2 of Check Your Progress 2.

### 3.5.4 Difference between Leaky Bucket Traffic Shaper and Token Bucket Traffic Shaper

Figure 3.35 differentiate between two types of traffic shapers:

Leaky Bucket	Token Bucket
<ul style="list-style-type: none"> <li>Leaky Bucket (LB) discards packets.</li> <li>With LB, a packet can be transmitted if the bucket is not full.</li> <li>LB sends the packets at an average rate.</li> <li>LB does not allow saving, a constant rate is maintained.</li> </ul>	<ul style="list-style-type: none"> <li>Token Bucket (TB) discards tokens.</li> <li>With TB, a packet can only be transmitted if, there are enough tokens to cover its length in bytes.</li> <li>TB allows for large bursts to be sent faster by speeding up the output.</li> <li>TB allows saving up of tokens (permissions) to send large bursts.</li> </ul>

Figure 3.35: Leaky Bucket Traffic Shaper and Token Bucket Traffic Shaper

## 3.6 Congestion Control in Packet-Switched Networks

Several control mechanisms for Congestion Control in packet switched network have been explored and published. **William Stalling** [Ref 3] has presented the following mechanism to handle congestion:

1. Send a control packet (choke packet) from a node where congestion has occurred to some or all source nodes. This choke packet will have the effect of stopping or slowing the rate of transmission from sources and therefore, it will reduce total load on the network. This approach requires additional traffic on the network during the period of congestion.
2. Make use of an end- to-end probe packet. Such a packet could be time stamped to measure the delay between two particular endpoints. This has the disadvantage of adding overhead to the network.
3. Allow packet-switching nodes to add congestion information to packets as they go by. There are two possible approaches here. A node could add such information to packets moving in the direction opposite to the congestion. This information reaches the source node quickly, and this reduces the flow of packets into the network. Alternatively, a node could add such information to packets moving in the same direction as the congestion. The destination either asks the source to adjust the load or returns the signal to the source in the packets (or acknowledgements) moving in the reverse direction.



#### 4.0

### CONCLUSION

This unit has dealt exclusively with the problem of congesting control in public switched network. You have therefore learnt the difference between congestion control and flow control, general principles of congestion control and congestion control mechanism.



#### 5.0 SUMMARY

In this unit, we examined several aspects of congestion i.e., what is Congestion? How does it occur? We also differentiated between Congestion Control and flow Control. Then, we gave two broad classification of Congestion control; open loop and closed loop. At the end, we touched upon issues related to congestion control in packet switched network.



#### 6.0 TUTOR MARKED ASSIGNMENT 11

1. Differentiate between Congestion Control and Flow Control.
2. What **are** the differences between open loop and closed loop solutions to congestion?
3. What are different approaches to open loop control?
4. What is the difference between leaky bucket traffic shaper and token bucket traffic shaper?



## 7.0 REFERENCES/FURTHER READINGS

A.S. Tanenbaum, *Computer Networks*. 5<sup>th</sup> Edition, Prentice Hall of India, New Delhi, 2011.

Leon Garcia and Indra Widjaja, *Communication Networks fundamental concepts and key architecture*, Tata McGraw Hill, New Delhi.

William Stallings, *Data and Computer Communication*, 6<sup>th</sup> edition, Pearson Edition, New Delhi, 2003.

## 8.0 ANSWER TO TUTOR MARKED ASSIGNMENT 11

### Question 1

Differentiate between Congestion Control and Flow Control.

### Solution

Sr. No.	Key	Flow Control	Congestion Control
1	Definition	Here, Traffic is controlled and Traffic stands for flow from sender to receiver.	Similarly, in this case, Traffic is controlled and Traffic stands for flow entering into the network.
2	Layers	Data link and Transport layers take care of flow control.	Network and Transport layers take care of congestion control.
3	Prime Focus	Receiver is hindered from being overawed.	Network is hindered from being crowded.
4	Responsibility	Only sender is handles for the traffic.	Transport layer is handles for the traffic.
5	Way	Traffic is hindered by slowing down the	Traffic is hindered by slowing down the

Sr. No.	Key	Flow Control	Congestion Control
		sender.	transport layer.

### Question 2

What are the differences between open loop and closed loop solutions to congestion?

### Solution

Open-loop congestion control policies make effort to disallow congestion through good design that ensures that congestion does not occur in the network. Closed-loop congestion control policies make effort to ease the impact of congestion through the concept of feedback loop

### Question 3

What are different approaches to open loop control?

### Solution

The different approaches to open loop control are:

- a. Admission control
- b. Traffic policing and its implementation
- c. Traffic shaping and its implementation

Explain them

### Question 4

What is the difference between leaky bucket traffic shaper and token bucket traffic shaper?

### Solution

The difference between leaky bucket traffic shaper and token bucket traffic shaper are in the table below:

Leaky Bucket	Token Bucket
<ul style="list-style-type: none"> <li>• Leaky Bucket (LB) discards packets.</li> <li>• With LB, a packet can be transmitted if the bucket is not full.</li> <li>• LB sends the packets at an average rate.</li> <li>• LB does not allow saving, a constant rate is maintained.</li> </ul>	<ul style="list-style-type: none"> <li>• Token Bucket (TB) discards tokens.</li> <li>• With TB, a packet can only be transmitted if, there are enough tokens to cover its length in bytes.</li> <li>• TB allows for large bursts to be sent faster by speeding up the output.</li> <li>• TB allows saving up of tokens (permissions) to send large bursts.</li> </ul>

## **UNIT 4 INTERNETWORKING**

### **CONTENTS**

- 1.0 Introduction
- 2.0 Objectives
- 3.0 Main Content
  - 3.1 Internetworking
    - 3.1.1 How does a Network differ?



	3.1.2 Networks Connecting Mechanisms
	3.1.3 Tunnelling and Encapsulation
3.2	Network Layer Protocols
	3.2.1 IP Datagram Formats
	3.2.2 Internet Control Message Protocol (ICMP)
	3.2.3 OSPF: The Interior Gateway Routing Protocol
	3.2.4 BGP: The Exterior Gateway Routing Protocol
4.0	Conclusion
5.0	Summary
6.0	Tutor-Marked Assignment
7.0	References/Further Readings



## 1.0 INTRODUCTION

There are many ways in which one network differs from another. Some of the parameters in which a network differs from another network are packet length, quality of services, error handling mechanisms, flow control mechanism, congestion control mechanism, security issues and addressing mechanisms. Therefore, problems are bound to occur when we require interconnection between two different networks. Different mechanisms have been proposed to solve this problem: Tunnelling is used when the source and destination are the same type of network but, there is a different network in-between, Fragmentation may be used for different maximum packet sizes of different networks. The network layer has a large set of protocols besides IP. Some of these are (OSPF) **Open shortest Path First** and (BGP) **Boarder Gateway Protocol** and (ICMP) **Internet Control Message Protocol**. In this unit, we will discuss some of these protocols as well as some internetworking mechanisms.



## 2.0 OBJECTIVES

After going through this unit, you should be able to:

- 1 list how are network differs from another
- 2 list the components of a network layer
- 3 define tunnelling and fragmentation concepts
- 4 discuss the field format of IP datagram, IP addressing
- 5 describe internet routing protocols, such OSPF and BGP
- 6 introduce Internet Control Message Protocol (ICMP).
- 7 **Take a cursory look at IPV6**



## 3.0 MAIN CONTENT

### 3.1 Internetworking

The Internet is comprised of several networks, each one with different protocols. There are many reasons for having different networks (thus different protocols):

- 1 Many personal computers use TCP/IP,
- 2 Many larger business organisations still use IBM mainframes with SNA Protocol.
- 3 Some PCs still run on Novell's NCP/IPX or Appletalk.
- 4 Wireless Network will have different protocols.
- 5 A large number of Telecommunication companies provide ATM facilities.

In this section, we will examine some issues that arise when two or more networks are interconnected. The purpose of interconnecting **that** is to allow any node or any network (e.g., Ethernet) to access data to any other node on any other network. (e, g., ATM). Users should not be aware of the existence of multiple networks

### 3.1.1 How does a Network differ?

**Tanenbaum** [Ref. 1] has defined several features (Kindly refer to **Figure 3.36**) that distinguishes one network from another. These differences **are** resolved while internetworking. All these features are defined at the network layer only, although, the network differs at the other layers too. They might have different encoding techniques at the physical layer, different frame formats at the data link layer, and different QoS at the transport layer etc.

Features	Options
Types of services	Connection-oriented, connection-less,
Protocols	IP, IPX, SNA, ATM
Addressing Scheme	Flat vs. Hierarchical
Maximum Packet size	Different for each network
Flow Control	Sliding window, Credit based
Congestion Control Mechanism	Leaky bucket, Token bucket, Hop by Hop, Choke Packets
Accounting	By connect time, packet by packet, byte by byte

**Figure 3.36: Different type of Networks**

### 3.1.2 Networks Connecting Mechanisms

We have been addressing the problems of connecting network in the earlier blocks also. Let us revisit these topics again. Networks can be connected by the following devices:

Repeaters, Hubs, **or switches** can be used to connect networks at the physical layer. The purpose of these devices is to move bits from one network to another network. **Hubs** are mainly analogue devices and do not understand higher layer protocols. **However, switches are digital connecting network devices used to send data to its destination. Switches are of different types. These are; LAN Switch, unmanaged switch, stackable switch and power over Ethernet (POE) switch.**

At data link layer, bridges and switches were introduced to connect multiple LANs. They work at the frame level rather than bits level. They examine the MAC address of frames and forward the frames to different LANs. They may do little translation from one protocol (e.g., Token ring, Ethernet) to another MAC Layer Protocol.

Routers were used at the network layer, which also does translation, in case the network uses different network layer protocols.

Finally, the transport layer and application layer gateways deal with conversion of protocols at the transport and application layer respectively, in order to interconnect networks.

The focus of **this** section is to introduce mechanism internetworking at the network layer. Therefore, we have to understand the difference between the **switching that** operates at the data link layer and routing that operate at the network layer.

The main difference between the two operations is that, with a switch, the entire frame is forwarded to a different LAN on the basis of its MAC address. With a router, the packet is extracted and encapsulated in a different kind of a frame and forwarded to a remote router on the basis of the IP address in the packet. Switches need not understand the network layer protocol to switch a packet, whereas, a router requires to do so. **Tanenbaum [Ref 1]** has described two basic mechanisms of internetworking: **Concatenated virtual circuit** and **connectionless internetworking**. In the next sections we will talk about them.

### **Concatenated Virtual Circuit**

This scheme is similar to the implementation of a connection-oriented service in which, a connection from the source router to the destination router must be established before any packet can be forwarded. This type of connection is called a virtual circuit, keeping with the analogue of the physical circuits set up by the telephone system and the subnet is called a Virtual Circuit Subnet. The idea behind a Virtual Circuit is to avoid choosing a new route for every packet to be forwarded. A route selected as a part of the connection setup is stored in tables inside the routers.

The essential feature of this mechanism is that a series of Virtual Circuits is setup from the source machine on one network to the destination machine on another network through one or more gateways. Just like a router, each gateway maintains tables, indicating the virtual circuits that are to be used for packet forwarding. This scheme works when all the networks follow the same QoS parameters. But, if only some networks support reliable delivery service, then all the schemes will not work. In summary, this scheme has the same advantage and disadvantage of a Virtual Circuit within a subnet.

### **Datagram Model**

Unlike the previous model, there is no concept of virtual circuits, therefore, there is no guarantee of packet delivery. Each packet contains the full source and destination address and are forwarded independently. This strategy uses multiple routes and therefore, achieves higher bandwidth.

A major disadvantage of this approach is that, it can be used over subnets that do not use Virtual Circuit inside. For example, many LAN and some mobile networks support this approach.

In summary, approach to internetworking is the same as datagram subnets: Congestion proves robustness in case of router failures.

### 3.1.3 Tunnelling and Encapsulation

It is used when the source and destination networks are the same but the network, which lies in-between, is different. It uses a mechanism called encapsulation where, a data transfer unit of one protocol is enclosed inside a different kind of protocol. Tunnelling allows us to carry one kind of frame that uses a particular network but uses, a different kind of frame.

Suppose two hosts located very far away from each other wants to communicate and both have access to the Internet link. It means that both of them are running TCP/IP based protocol. The carrier (WAN) which lies between the two hosts is based at X.25. Its format is different from TCP/IP. Therefore, the IP datagram forwarded by the host one will be encapsulated in X.25 network layer packet and will be transported to the address of the router of the destination host, when it gets there. The destination router removes the IP packet and sends it to host 2. WAN can be considered as a **big tunnel** extending from one router to another. [Ref 1]. The packet from host J travels from one end of a X.25 based tunnel to another end of the tunnel encapsulated properly. Sending and receiving hosts are not concerned about the process. It is done by the concerned router at the other end.

## 3.2 Network Layer Protocols

In the network layer, the **Internet** can be viewed as a collection of subnetworks or Autonomous systems that are interconnected. End systems are not usually directly attached to each other via a single communication link. Instead, they are directly connected to each other through intermediate switching devices known as routers. A router takes a chunk of information arriving on, one of its incoming links and forwards that chunk of information on one of its outgoing communication channels. Routing and communication links are a part of Internet service providers. To allow communication among Internet users and to allow users to access worldwide **Internet** content, these lower tier ISPs are interconnected through national and international upper tier ISPs. An upper tier ISP consists of high-speed routers interconnected with high speed fibre-optic channels [Ref 5]. Each **ISP** network whether upper tier or lower tier, is managed independently and runs the **IP** Protocol which holds the whole **Internet** together and provides a best-efforts (not guaranteed) service to forward information (datagrams) from source to destination without regards to where the machines are located. In this section, we will introduce several network layers protocols. **Figure 3.37** shows the network layer with these major components [Ref 5]:

- 1 IP
- 2 ICMP
- 3 RIP, OSPF and BGP

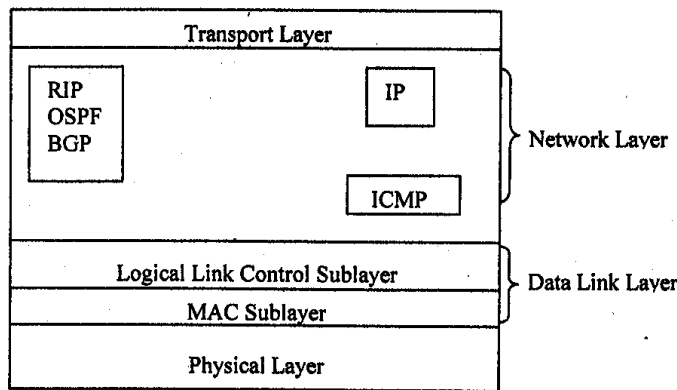

Figure 3.37: Network layer protocols

- (i) **IP:** The first component is IP Protocol, which defines the followings:
  1. Fields in IP datagram
  2. Address formats
  3. Action taken by routers and end systems on an IP datagram based on the values in these fields.
- (ii) **ICMP:** The Second Component of the network layer is ICMP (Internet Control Message Protocol) used by the hosts, routers and gateways to communicate network layer information to each other. The most typical use of ICMP is for error reporting.
- (iii) **Routing Information Protocol (RIP), OSPF and BGP:** The third component is related to routing protocols: RIP and OSPF are used for Intra-AS routing, whereas, BOP is used as exterior gateway routing protocol.

Now we will describe each component separately.

### 3.2.1 IP Datagram Formats

An IP datagram consists of a header part and a data part. The header has a 20-byte fixed part and a variable length optional part as shown in the *Figure 3.38 (a)*. The header format is shown in *Figure 3.38(b)*. It is transmitted in big-endian order: from left to right, with the high-order bit of the Version field going first. On little endian machines, software conversion is required on both the transmission header as well as the reception header. The key fields in the **IPv4** Internet Protocol version 4 datagram headers are the followings.

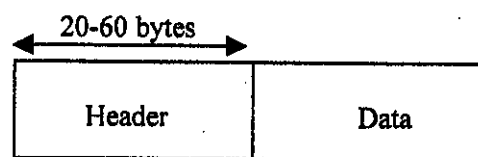

Figure 3.38 (a): IP datagram

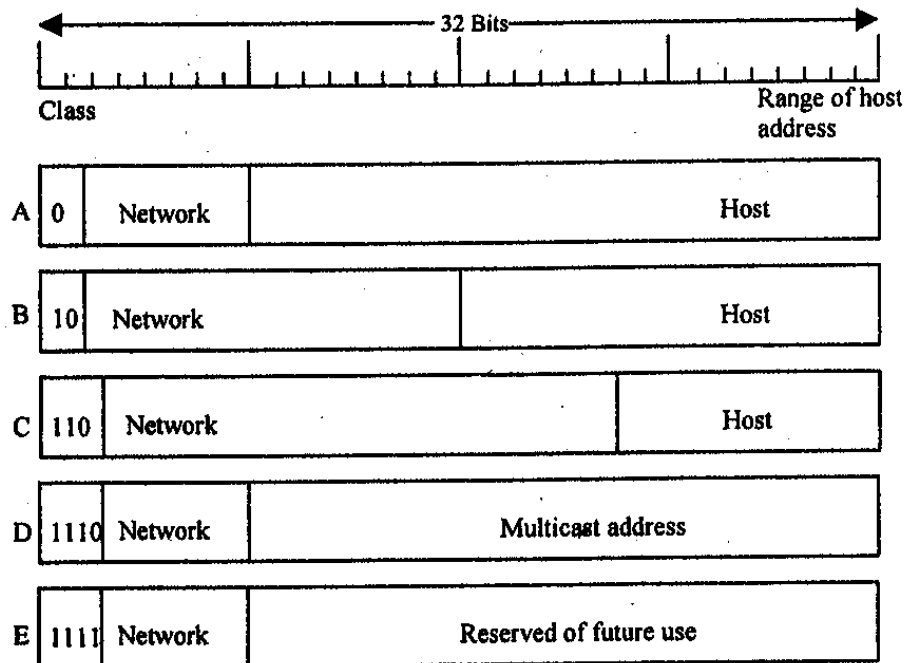

Figure 3.38 (b): IP address formats

The Version field specifies the IP version of the protocol, the datagram belongs to. By including the version in each datagram, the router can determine/interpret the remainder of the IP datagram.

#### Header length (4 bits)

The field defines the length of the header in multiples of four bytes. The four bytes can represent a number between 0 and 15, which when multiplied by 4, results in 60 bytes. A typical IP datagram has 20-byte header only, because most IP datagram do not contain options.

The *Type of service* (8 bits) defines how the datagram should be handled. It defines bits to specify priority, reliability, delay, level of throughput to meet the different requirements. For example, for digitised voice, fast delivery, beats accurate delivery. For file transfer, error-free transmission is more important than fast transmission.

The *Total length* includes everything in the datagram both header and data. The maximum length is 65,535 bytes. At present, this upper limit is tolerable, but with future gigabit networks, larger datagrams may be needed.

The *Identification* field is used in fragmentation. A datagram when passing through different networks may be broken into several fragments to match the network frame size. Once the fragmentation occurs, each fragment is identified with a sequence number to this field.

Surprisingly, the **IPv4** does not permit the fragmentation of the IP datagram at the routers level.

Next, comes an unused bit and then two I-bit fields. **DF** stands for **Don't Fragment**. It is an order to the router not to fragment the datagram because, the destination is incapable of putting the pieces back together again.

**MF** stands for **More Fragments**. All fragments except the last one **has** this bit set. It is needed to know when all fragments of a datagram have arrived.

The *Fragment offset* (13 bits) depicts the location of the current datagram, this fragment belongs to **a**ll fragments except, the last one in a datagram, must be multiple of 8 bytes, the elementary fragment unit. Since 13 bits are provided, there is a maximum of 8192 fragments per datagram, with a maximum datagram length of 65,536 bytes, one more than the *Total length field*.

The *Time to live* (8 bit) field is a counter used to limit packet lifetimes. It is supposed to count time in seconds allowing a maximum lifetime of 255 sec. It must be decremented on each hop and is supposed to be decremented multiple times when queued for a long time in the router. In practice, it just counts hops. When it hits zero, the packet is dropped and a warning packet is sent back to the source host. This feature, prevents datagrams from wandering around forever, something that otherwise might happen if the routing tables become corrupted.

*Protocol* (8 bits) is used when IP reaches its final destination. When, the network layer has assembled a complete datagram, it needs to know what to do with it. The *Protocol* field identifies the transport protocol the network layers needs to give it to. TCP is one possibility, but so are UDP and some others. The numbering of protocols is global across the entire Internet.

The Header checksum verifies the header only. Such a checksum is useful for detecting errors generated by bad memory words inside a router. This algorithm is more robust than a normal add. Note, that the *Header checksum* must be recomputed at each hop because, at least one field always changes (the *time to live* field), but tricks can be used to speed up the computation.

The *Source address* and *Destination IP address*: These fields carry the 32 bit IP addresses of the source and destination address. One portion of the IP address indicates the network and the other portions indicate the host (or router) on the network. The IP addresses will be described in the next section.

The *Option field* (32 bits): This field allows an IP header to be extended to be more functional. It can carry fields that control routing, timing and security.

## **IP Addressing**

All IP addresses are 32 bits long and are used in the *Source address and Destination address* fields of IP packets.

In addition, to the physical addresses (contained on NICs) that identify individual devices, the Internet requires an additional addressing convention, an address that identifies the connection of a host to its network. Before discussing the IP addressing, let us discuss, a host and a router. A router is, fundamentally different from a host whose job is receive a datagram on an incoming link from a host and forward it on some outgoing link. Both router and a host are connected to a link through an interface. **A** Router has multiple interfaces whereas, a host has a single interface.



Because every host and a router is capable of sending and receiving IP datagram, IP requires each host and router interface to have its own IP address. Thus, an IP address is technically associated with an interface rather than with the host or a router.

For several decades, IP addresses were divided into the five categories given in the [Figure 3.38\(b\)](#). The different classes are designed to cover the needs of different types of organisations.

The three main address classes are class A, class B, and class C. By examining the first few bits of an address, IP software can quickly determine the class, and therefore, the structure, of an address. IP follows these rules to determine the address class:

### **Class A**

If, the first bit of an IP address is 0, it is the address of a class A network. The first bit of a class A address identifies the address class. The next 7 bits identify the network, and the last 24 bits identify the host. There are fewer than 128 class A network numbers, but each class A network can be composed of millions of hosts.

### **Class B**

If, the first 2 bits of the address are 10, it is a class B network address. The first 2 bits identify class; the next 14 bits identify the network, and the last 16 bits identify the host. There are thousands of class B network numbers and each class B network can contain thousands of hosts.

### **Class C**

If, the first 3 bits of the address are 110, it is a class C network address. In a class C address, the first 3 bits are class identifiers; the next 21 bits are the network address, and the last 8 bits identify the host. There are millions of class C network numbers, but each class C network is composed of fewer than 254 hosts.

### **Class D**

If, the first 4 bits of the address are 1110, it is a multicast address. These addresses are sometimes called class D addresses, but they don't really refer to specific networks. Multicast addresses are used to address groups of computers together at moment in time. Multicast addresses, identify a group of computers that share a common application, such as a video conference, as opposed to a group of computers that share a common network.

### **Class E**

If, the first four bits of the address are 1111 it is a special reserved address. These addresses are called class E addresses, but they don't really refer to specific networks. No numbers are currently assigned in this range.

IP addresses are usually written as four decimal numbers separated by dots (periods). Each of the four numbers is in the range 0-255 (the decimal values possible for a



single byte). Because the bits that identify class are contiguous with the network bits of the address, we can lump them together and look at the address as composed of full bytes of network address and full bytes of host address. If the value of the first byte is:

Less than 128, the address is class A; the first byte is the network number, and the next three bytes are the host address.

From 128 to 191, the address is class B; the first two bytes identify the network, and the last two bytes identify the host.

From 192 to 223, the address is class C; the first three bytes are the network address, and the last byte is the host number.

From 224 to 239, the address is multicast. There is no network part. The entire address identifies a specific multicast group.

Greater than 239, the address is reserved.

Figure 3.39 depicts each class range with other details.

IP Address Class	High Order Bit (s)	Format	Range	No. of Network Bits	No. of Host Bits	Max. Hosts	Purpose
A	0	N.H.H.H	1.0.0.0 to 126.0.0.0	7	24	$2^{24}-2$	Few large organisations
B	1,0	N.N.H.H	128.1.0.0 to 191.254.0.0	14	16	$2^{16}-2$	Medium-size organisations
C	1,1,0	N.N.N.H	192.0.1.0 to 223.255.254.0	21	8	$2^8-2$	Relatively small organisations
D	1,1,1,0	N/A	224.0.0.0 to 239.255.255.255	N/A	N/A	N/A	Multicast groups (RFC 1112)
E	1,1,1,1	N/A	240.0.0.0 to 254.255.255.255	N/A	N/A	N/A	Future Use (Experimental)

Figure 3.39: IP address classes in dotted decimal format with their range.

The IP address, which provides, universal addressing across all the networks of the Internet, is one of the great strengths of the TCP/IP protocol suite. However, the original class structure of the IP address has weaknesses. The TCP/IP designers did not envision the enormous scale of **today's** network. When TCP/IP was being designed, networking was limited to large organisations that could afford substantial computer systems. The idea of a powerful UNIX system on every desktop did not exist. At that time, a 32-bit address seemed so large that it was divided into classes to reduce the processing load on routers, even though dividing the address into classes sharply reduced the number of host addresses actually available for use. For example, assigning a large network, a single class B address, instead of six class C addresses, reduced the load on the router because the router needed to keep only one route for that entire organisation. However, an organisation that was given the class B address probably did not have 64,000 computers, so most of the host addresses available to the **organisation** were never assigned.

The class-structured address design was critically strained by the rapid growth of the Internet. At one point it appeared that all class B addresses might be rapidly exhausted. To

prevent this, a new way of looking at IP addresses without a class structure was developed.

### **Subnet Masks and CIDR Networks (Classless IP Addresses)**

IP addresses are actually 32-bit binary numbers. Each 32-bit IP address consists of two sub addresses, one identifying the network and the other identifying the host to the network, with an imaginary boundary separating the two. The location of the boundary between the network and host portions of an IP address is determined through the use of a subnet mask. A subnet mask is another 32-bit binary number, which acts like a filter when applied to the 32-bit IP address. By comparing a subnet mask with an IP address system, can determine the portion of the IP address that relates to the network, and the portion that relates to the host. Wherever, the subnet mask has a bit set to “1”, the underlying bit in the IP address is part of the network address. Wherever the subnet mask is set to “0”, the related bit in the IP address is part of the host address. For example, assume that the IP address 11000000101010000000000100010100 has a subnet mask of 11111111111111111111111100000000. In this example, the first 24 bits of the 32-bit IP addresses are used to identify the network, while the last 8 bits are used to identify the host **address of** that network.

The size of a network (i.e., the number of host addresses available for use on it) is a function of the number of bits used to identify the host portion of the address. If, a subnet mask shows that 8 bits are used for the host portion of the address block, a maximum of 256 possible host addresses are available for that specific network. Similarly, if a subnet mask shows that 16 bits are used for the host portion of the address block, a maximum of 65,536 possible host addresses are available for use on that network.

If a network administrator needs to split a single network into multiple virtual networks, the bit-pattern in use with the subnet mask can be changed to allow as many networks as necessary. For example, assume that we want to split the 24-bit 192.168.10.0 network (which allows for 8 bits of host addressing, or a maximum of 256 host addresses) into two smaller networks. All we have to do in this situation is, change the subnet mask of the devices on the network so that they use 25 bits for the network instead of 24 bits, resulting in two distinct networks with 128 possible host addresses on each network. In this case, the first network would have a range of network addresses between 192.168.10.0 -192.168.10.127, while the second network would have a range of addresses between 192.168.10.128 -192.168.10.255.

Networks can also be enlarged through the use of a technique known as “**supernetting**,” which works by extending the host portion of a subnet mask to the left, into the network portion of the address. Using this technique, a pair of networks with 24-bit subnet masks can be turned into a single large network with a 23-bit subnet mask. However, this works only if you have two neighbouring 24-bit network blocks, with the lower network having an even value (when the network portion of the address is shrunk, the trailing bit from the original network portion of the subnet mask should fall into the host portion of the new subnet mask, so the new network mask will consume both networks). For example, it is possible to combine the 24-bit 192.168.10.0 and . 192.168.11.0 networks together since the loss of the trailing bit from each network (00001010 vs. 00001011) produces the same 23-bit subnet

mask (000001x), resulting in a consolidated 192.168.10.0 network. However, it is not possible to combine the 24-bit 192.168.11.0 and 192.168.12.0 networks, since the binary values in the seventh bit position (00001011 vs. 00001100) do not match when the trailing bit is removed.

## **Classless Inter-Domain Routing**

In the modern networking environment defined by RFC 1519 [Classless Inter-Domain Routing (CIDR)], the subnet mask of a network is typically annotated in written form as a “slash prefix” that trails the network number. In the subnetting example in the previous paragraph, the original 24-bit network would be written as 192.168.10.0/24, while the two new networks would be written as 192.168.10.0/25 and 192.168.10.128/25. Likewise, when the 192.168.10.0/24 and 192.168.11.0/24 networks were joined together as a single supernet, the resulting network would be written as 192.168.10.0/23. Note, that the slash prefix annotation is generally used for human benefit; infrastructure devices still use the 32-bit binary subnet mask internally to identify networks and their routes. All networks must reserve host addresses (made up entirely of either ones or zeros), to be used by the networks themselves. This is so that, each subnet will have a network-specific address (the all-zeroes address) and a broadcast address (the all-ones address). For example, a /24 network allows for 8 bits of host addresses, but only 254 of the 256 possible addresses are available for use. Similarly, /25 networks have a maximum of 7 bits for host addresses, with 126 of the 128 possible addresses available (the all-ones and all-zeroes addresses from each subnet must be set aside for the subnets themselves). All the systems on the same subnet must use the same subnet mask in order to communicate with each other directly. If, they use different subnet masks they will think they are on different networks, and will not be able to communicate with each other without going through a router first. Hosts on different networks can use different subnet **mask**, although the routers will have to be aware of the subnet masks in use on each of the segments.

Subnet masks are used only by systems that need to communicate with the network directly. For example, external systems do not need to be aware of the subnet masks in use on your internal networks, since those systems will route data to your network by way of your parent network's address block. As such, remote routers need to know only the provider's subnet mask. For example, if you have a small network that uses only a /28 prefix that is, a subset of your ISP's /20 network, remote routers need to know only about your upstream provider's /20 network, while your upstream provider needs to know your subnet mask in order to get the data to your local /28 network. The rapid depletion of the class B addresses showed that three primary address classes were not enough: class A was much too large and class C was much too small. Even a class B address was too large for many networks but was used because it was better than the other alternatives.

The obvious solution to the class B address crisis was to force organisations to use multiple class C addresses. There were millions of these addresses available and they were in no immediate danger of depletion. As is often the case, the obvious solution is not as simple as it may seem. Each class C address requires its own entry within the routing table. Assigning thousands or millions of class C addresses would cause the routing table to grow so rapidly that the routers would soon be overwhelmed. The

solution requires a new way of assigning addresses and a new way of looking at addresses.

Originally network addresses were assigned in more or less sequential order as they were requested. This worked fine when the network was small and centralised. However, it did not take network topology into account. Thus, only random chance would determine if the same intermediate routers would be used to reach network 195.4.12.0 and network 195.4.13.0, which makes it difficult to reduce the size of the routing table. Addresses can only be aggregated if they are contiguous numbers and are reachable through the same route. For example, if addresses are contiguous for one service provider, a single route can be created for that aggregation because that service provider will have a limited number of routes to the Internet. But if one network address is in France and the next contiguous address is in Australia, creating a consolidated route for these addresses will not work.

Today, large, contiguous blocks of addresses are assigned to large network service providers in a manner that better reflects the topology of the network. The service providers then allocate chunks of these address blocks to the organisations to which they provide network services. This alleviates the short-term shortage of class B addresses and, because the assignment of addressees reflects the topology of the network, it permits route aggregation. Under this new scheme, we know that network 195.4.12.0 and network 195.4.13.0 are reachable through the same intermediate routers. In fact, both these addresses are in the range of the addresses assigned to Europe, 194.0.0.0 to 195.255.255.255. Assigning addresses that reflect the topology of the network enables route aggregation, but does not implement it. As long as network 195.4.12.0 and network 195.4.13.0 are interpreted as separate class C addresses, they will require separate entries in the routing table. A new, flexible way of defining addresses is therefore, needed.

Evaluating addresses according to the class rules discussed above limits the length of network numbers to 8, 16, or 24 bits -1, 2, or 3 bytes. The IP address, however, is not really byte-oriented. It is 32 contiguous bits. A more flexible way to interpret the network and host portions of an address is with a bit mask. An address bit mask works in this way: if a bit is on in the mask, that equivalent bit in the address is interpreted as a network bit; if a bit in the mask is off, the bit belongs to the host part of the address. For example, if address 195.4.12.0 is interpreted as a class C address, the first 24 bits are the network numbers and the last 8 bits are the host addresses. The network mask that represents this is 255.255.255.0, 24 bits on and 8 bits off. The bit mask that is derived from the traditional class structure is called the default mask or the natural mask.

However, with bit masks we are no longer limited by the address class structure. A mask of 255.255.0.0 can be applied to network address 195.4.0.0. This mask includes all addresses from 195.4.0.0 to 195.4.255.255 in a single network number. In effect, it creates a network number as large as a class B network in the class C address space. Using bit masks to create networks larger than the natural mask is called supernetting, and the use of a mask instead of the address class to determine the destination network is called Classless Inter-Domain Routing (CIDR).

Specifying both the address and the mask is cumbersome when writing out addresses. A shorthand notation has been developed for writing CIDR addresses. Instead of

writing network 172.16.26.32 with a mask of 255.255.255.224, we can write 172.16.26.32/27. The format of this notation is address/prefix-length, where prefix-length is the number of bits in the network portion of the address. Without this notation, the address 172.16.26.32 could easily be interpreted as a host address. RFC 1878 list all 32 possible prefix values. But little documentation is needed because the CIDR prefix is much easier to understand and remember than address classes. I know that 10.104.0.19 is a class A address, but writing it as 10.104.0.19/8 shows me that this address has 8 bits for the network number and therefore, 24 bits for the host number. I don't have to remember anything about the class A address structure.

### Internet-layer Versus Private Addressing

Although the pool of IP addresses is somewhat limited, most companies have no problems obtaining them. However, many organisations have already installed TCP/IP products on their internal networks without obtaining “legal” addresses from the proper sources. Sometimes these addresses come from example books or are simply picked at random (several firms use networks numbered 1.2.3.0, for example). Unfortunately, since they are not legal, these addresses will not be usable when these organisation attempt to connect to the Internet. These firms will eventually have to reassign Internet-legal IP addresses to all the devices on their networks, or invest in address-translation gateways that rewrite outbound IP packets so they appear to be coming from an Internet-accessible host.

Even if an address-translation gateway is installed on the network, these firms will never be able to communicate with any site that is a registered owner of the IP addresses in use on the local network. For example, if you choose to use the 36.0.0.0/8 address block on your internal network, your users will never be able to access the computers at Stanford University, the registered owner of that address block. Any attempt to connect to a host at 36.x.x.x will be interpreted by the local routers as a request for a local system, so those packets will never leave your local network.

Not all firms have the luxury of using Internet-legal addresses on their hosts, for any number of reasons. For example, there may be legacy applications that use hardcode addresses, or there may be many systems across the organisation for a clean upgrade to be successful. If you are unable to use Internet-legal addresses, you should at least be aware that there are groups of “private” Internet addresses that can be used on internal networks by anyone. These address pools were set- aside in RFC 1918, and therefore, cannot be “assigned” to any organisation. The Internet's backbone routers are configured explicitly not to route packets with these addresses, so they are completely useless outside an organisation's internal network. The address blocks available are listed in figure 3.40.

Class	Range of Addresses
A	Any addresses in 10.x.x.x
B	Addresses in the range of 172.16.x.x-172.31.x.x
C	Addresses in the range of 192.168.0.x-192.168.255.x

Figure 3.40: Private Addresses Provided in RFC 1918

Since these addresses cannot be routed across the Internet, you must use an address-translation gateway or a proxy server in conjunction with them. Otherwise, you will not be able to communicate with any hosts on the Internet.

An important note here is that, since, nobody can use these addresses on the Internet, it is safe to assume that anybody who is using these addresses is also utilising an address-translation gateway of some sort. Therefore, while you will never see these addresses used as destinations on the Internet, if your organisation establishes a private connection to a partner organisation that is using the same block of addresses that you are using, your firms will not be able to communicate on the Internet. The packets destined for your partner's network will appear to be local to your network, and will never be forwarded to the remote network.

There are many other problems that arise from using these addresses, making their general usage difficult for normal operations. For example, many application-layer protocols embed addressing information directly into the protocol stream, and in order for these protocols to work properly, the address-translation gateway has to be aware of their mechanics. In the preceding scenario, the gateway has to rewrite the private addresses (which are stored as application data inside the application protocol), rewrite the UDP/TCP and IP checksums, and possibly rewrite TCP sequence numbers as well. This is difficult to do even with simple and open protocols such as FTP, and extremely difficult with proprietary, encrypted, or dynamic applications (these are problems for many database protocols, network games, and voice-over-IP services, in particular). These gateways almost never work for all the applications in use at a specific location.

It is always better to use formally-assigned, Internet-legal addresses whenever possible: even if, the hosts on your network do not necessarily require direct Internet access. In those cases, in which your hosts are going through a firewall or application proxy of some sort, the use of Internet-legal addresses causes the least amount of maintenance trouble over time. If, for some reason this is not possible, use one of the private address pools described in [Figure 3.40](#). Do not use random, self-assigned addresses if you can possibly avoid it, as this will only cause connectivity problems for you and your users.

## **Fragmentation**

Fragmentation is process of breaking bigger IP datagrams into smaller fragments. Each network imposes some maximum size on its packets. Maximum payloads range from 48 bytes (ATM cells) to 65,515 bytes (IP packets), although the payload size in higher layers is often bigger.

What happens if the original host sends a source packet which is too large to be handled by the destination network? The routing algorithm can hardly bypass the destination.

Basically, the only solution to the problem is to allow routers to break up packets into **fragments**.



The data in the IP datagram is broken among two or more smaller IP datagrams and these smaller fragments are then sent over the outgoing link.

The real problems in the fragmentation process is reassembly of fragments into a single IP datagram before sending it to the transport layer. If it is done at the network level, it will decrease the performance of a router. Therefore, to keep the network layer simple. **IPv4**. designer has left it to be done at the receiver level. When the destination host receives a series of fragments from the same host, it examines the identification number of a fragment, its flag number (the flag bit is set 100 for the last fragment whereas it is a set to 1 for all the other fragments). This is required because one or more fragments may never reach because IP provides best efforts service. **Offset** field is used to determine where the fragment fits within the original IP datagram [Rej5]. When all the packets have arrived, the destination host reassembles them and sends it to the transport layer. The following table illustrates an example of 5000 bytes (20 bytes of IP header plus 4980 bytes of IP Payload arrives at a router which must be forwarded to the outgoing link 'with a maximum transfer unit of 1500 bytes (equivalent to Ethernet frame size).

Fragment	Bytes	ID	Offset	Flag
1st Fragment	1,480 bytes in the data field of the IP datagram	Identification = 999	Offset = 0 (meaning the data should be inserted beginning at byte 0)	Flag = 1 (meaning there is more)
2nd Fragment	1,480 byte information field	Identification = 999	Offset = 1,480 (meaning the data should be inserted beginning at byte 1,480)	Flag = 1 (meaning there is more)
3rd Fragment	1,480 byte information field	Identification = 999	Offset = 2,960 (meaning the data should be inserted beginning at byte 2,960)	Flag = 1 (meaning there is more)
4th Fragment	220 bytes (=4,980-1,480-1,480-1,480)	Identification = 999	Offset = 4,440 (meaning the data should be inserted beginning at byte 4, 440)	Flag = 0 (meaning this is the last fragment)

Figure 3.41: Fragmentation Table

This means that 4,980 data bytes in the original datagram must be allocated to four separate segments (each of which are also IP datagram). The original datagram has been stamped with an identification number 999. It is desirable to have a minimum number of fragments because fragmentation and reassembling creates extra overheads or a network system and a host. This is done by limiting the size of UDP and TCP segments to small size.

### 3.2.2 Internet Control Message Protocol (ICMP)

It is a protocol used by hosts and routers to send notification of datagram problems. The most typical use of ICMP is for error reporting. We have encountered errors such as, “Destination network unreachable” while running a telnet, FTP or HTTP session. This type of error reporting is done by ICMP [Ref5]. As we are aware, IP is an unreliable and connection less protocol, due to which, very often, a datagram may not reach the destination because of a link failure, congestion etc. ICMP does reporting of such cases to the sender.

ICMP is often considered part of **IP** but architecturally lies just above IP as ICMP messages are carried inside IP packets. Similar TCP and UDP segments which are carried as IP payloads, ICMP messages are also carried as IP payloads. Note, that, a datagram carries only the addresses of the original sender and the final destination. It

does not know the addresses of the previous router (s) that passed a message. For this reason, ICMP can send messages only to the source and not to an intermediate router. Student are required to refer to Reference [1] & [5] for details of message types.

### 3.2.3 OSPF: The Interior Gateway Routing Protocol

Open Shortest Path First (OSPF) has become standard interior gateway routing protocol. It supports many advanced features [Ref1 and Ref5] to meet a long list of requirements.

The protocol specification should be publicly available. **O** in OSPF stands for **open**. It means that OSPF is not a proprietary protocol.

It is a **dynamic algorithm** one that adapts to changes in the topology automatically and quickly.

**Load distribution:** When multiple paths to a destination have the same cost OSPF allows multiple paths to be used.

**Support for hierarchy** within a single routing domain. By 1988, the **Internet** had grown so large that no router was expected to know the entire topology. OSPF was designed so that no router would have to do so.

**Security:** All exchanges between OSPF routers are authenticated and allows only trusted routers **10** participate. OSPF supports three kinds of connections and networks [Ref1]

- 1 Point-to-point lines between two routers only.
- 2 Multi-access networks with broadcasting (e.g., LANs).
- 3 Multi-access networks without broadcasting (e.g., Packet Switched WANs).

OSPF identifies four types of routers:

- (i) Internal routers (within one area).
- (ii) Area border routers (connects two or more areas).
- (iii) Backbone routers (performs routing within the backbone).
- (iv) **Autonomous Systems** (AS) boundary routers (exchanges routing information with routers in other ASes).

OSPF allows a longer AS to be divided into smaller areas. Topology and details of one area is not visible to others. Every AS has a backbone area (called Area 0) as shown in **Figure 3.42**.



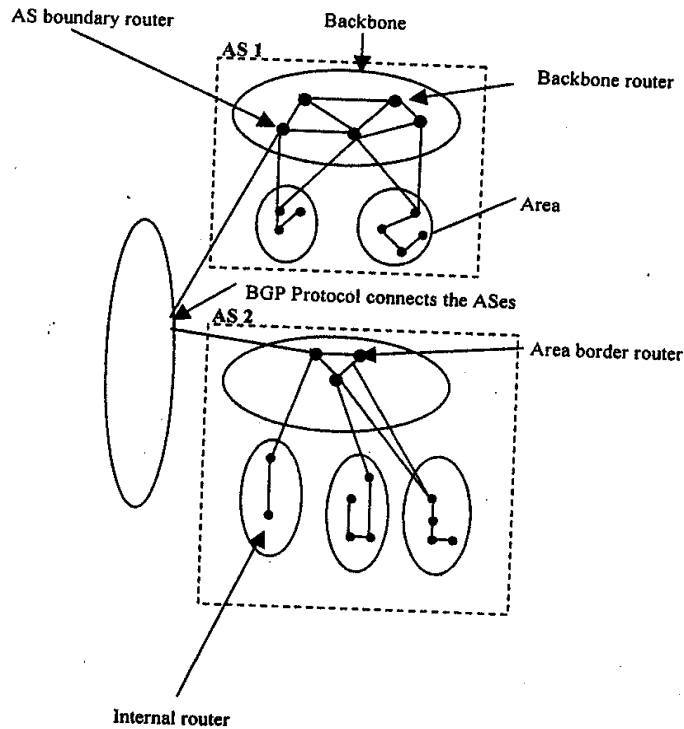

Figure 3.42: Working domain of OSPF

All areas are connected to the backbone possibly by a tunnel, so it is possible to move from one area to another area through a backbone. The primary role of the backbone area is to route traffic between the other areas in the AS. Inter area routing within the AS requires the follows movement of packets as shown below by arrows.

Host internal router of an area border router of a source area backbone area border router of a destination area internal router of a destination area final destination

After having described all the components of OSPF, let us now conclude the topic by describing its operation.

At its heart, however, OSPF is a link state protocol that uses flooding of link state information and Dijkstra's Least-Cost path algorithm. Using flooding each router informs all other routers in its area of its neighbours and costs. This information allows each router to construct the graph for its area (s) and computers the shortest path using Dijkstra's algorithm. This is done by backbone routers also. In addition, backbone routers accept information from the area border routers in order to compute the best route from each backbone router to every other router. This information is propagated back to area border routers, which advertise it within their areas. In this manner, the optimal route is selected.

### 3.2.4 BGP: The Exterior Gateway Routing Protocol

The purpose of Border Gateway Protocol is to enable two different ASes to exchange routing information so that, IP traffic can flow across the AS border. A different protocol is needed between the ASes because the objectives of an interior gateway and exterior gateway routing protocol are different. Exterior gateway routing protocol such as BGP is related to policy matters. BGP is fundamentally a distance

vector protocol but, it is more appropriately characterised as path vector protocol [Ref 5]. Instead of maintaining just the cost to each destination, each BGP router keeps track of the path used [Ref]]. Neighbouring BGP routers, known as BGP peers exchange detailed information along with the list of ASes on a path to a given destination rather than record cost information.

The main advantage of using BGP is to solve the count to infinity problem which is illustrated in the following Figure 3.43.

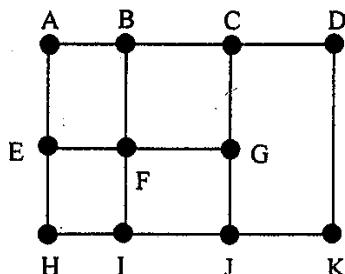

Figure 3.43: Solution to Count to infinity problems in BGP

In this figure 3.43 there are A, B, C, D, E, F, G, H, I, J and K routers. Now consider G's routing table. G uses G C D K path to forward a packet to K. As discussed earlier whenever a router gives any routing information, it provides a complete path.

**For example**, from A, the path used to send a packet to K is ABCDK

From B-the path used is BCDK

From C-the path used is CGJK

From E-EFGJK

From H-HIJK.

After receiving all the paths from the neighbours, D will find the best route available. It will outright reject the path from C and E, since they pass through D itself. **Therefore, the choice left is between a route announced by B and H.** BGP easily solves count to infinity problems. Now, suppose C crashes or the line B-C is down. Then if B receives, two routes from its 2 neighbours: ABCDK and FBCDK, then these which can be rejected because it passes through C itself. Other distance vector algorithms make the wrong choice because, they cannot tell which of their neighbours have independent routes to their destination or not.

The method of routing data from one place to another which we have discussed so far is based on IPv4 which was invented in 1981(RFC 791). This protocol assisted in the growth of Internet until it started having problem due to:

1. Lack of enough address space because of the exponential growth of the address and the final depletion of the address.
2. Lack of enough IPv4 header which does not give room for the headed additional parameters.
3. Security problem with the use of IPv4
4. Poor quality of service support due to assignment of information about bandwidth.

Several efforts were made to slow down the depletion rate of the IPv4 that is, to extend the life span of IPv4. Such efforts were the introduction of Network Address Translation

(NAT), the use of subnetting and classless interdomain routing (CIDR). Finally, Internet Protocol Version 6 (IPv6) was drafted by Internet Engineering Task Force (IETF) in 1998 (RFC 1883) which was obsoleted by RFC 2460 and became an Internet standard on 14<sup>th</sup> July, 2017 (RF8200). Let us discuss IPv6.

### **Internet Protocol Version 6 (IPv6)**

Internet Protocol Version 6 (IPv6) is an Internet Standard (RFC 8200) which is meant to identify and create computer devices and other devices on interconnected systems and transfers traffic through the Internet. It was developed to solve the problems of IPv4. IPv6 has 128-bit address, that is,  $2^{128}$  or  $3.4 \times 10^{38}$  addresses. It solves IPv4 problems by;

1. Providing very large address space
2. Giving room for tree-like address system thereby providing route in aggregation throughout the Internet, and restricting the enlargement of routing tables.
3. Enlarging and making easy employment of multicast addressing, thus, giving room for providing services in the most effective way possible.

IPv6 address is represented as

2001:0db8:0000:0000: 0000:8a2e:370,7334

Which can also be written as

2001:0db8::8a2e: 0370:7334.

IPv4 to IPv6 transition assumes will take a long time. There are several methods of transiting from IPv4 to IPv6. Some of the methods are;

#### **1. Dual stock**

This is system of running IPv4 and IPv6 on the same machine at the same time. Many computer devices presently support IPv4 and IPv6.

#### **2. Tunnelling**

This is a method of conveying IPv6 traffic via IPv4 network. In this case, packets are enclosed into a wrapper that allows the transfer from source to the destination limpidly from where it can be retransmitted. There are several methods of tunnelling. Such methods are manual IPv6 tunnels, Generic routing encapsulation (GRE) IPv6 tunnels, 6 to 4 tunnels, IPv4 compatible tunnels and intra-site automatic tunnel addressing protocol (ISATAP) tunnels.

#### **3. Translation**

This allows IPv6 to be transformed into IPv4 and vice-versa. In this case, the traffic is charged (not encapsulated) to the destination type which can either be IPv4 or IPv6. Translation methods are network address translation and NAT64.

### **Converting from IPv4 to IPv6**

It is pertinent to note from our discussions that it is obvious to convert IPv4 to binary using the four octets. Similarly, it is also easy to convert IPv6 to binary using the 16 8-bit octets.

## Self-Study Exercise

### 1. Convert 172.16.254.1 from decimal to binary

#### Solution

To convert 172.16.254.1 to binary, it is easy to use a setup table of Binary Coded Decimal (BCD) number such as:

$2^7$	$2^6$	$2^5$	$2^4$	$2^3$	$2^2$	$2^1$	$2^0$
128	64	32	16	8	4	2	1
1	0	1	0	1	1	0	0

Use this table and the steps below to convert for a start,  $172_{10}$  to binary number.

Step 1

$$\begin{array}{r} 1 \\ 128 \overline{) 172} \\ \underline{128} \\ 44 \end{array}$$

Step 2

$$\begin{array}{r} 0 \\ 64 \overline{) 44} \end{array}$$

64 cannot divide 44 so, write 0 down

Step 3

$$\begin{array}{r} 1 \\ 32 \overline{) 44} \\ \underline{32} \\ 12 \end{array}$$

Step 4

$$\begin{array}{r} \\ 16 \overline{) 12} \end{array}$$

16 cannot divide 12 so write 0 down

Step 5

$$\begin{array}{r} 1 \\ 8 \overline{) 12} \\ \underline{8} \\ 4 \end{array}$$

Step 6

$$\begin{array}{r} 1 \\ 4 \overline{) 4} \\ \underline{4} \\ 0 \end{array}$$

The remainder in step 6 is 0 so write 0 under 2 and 1 since there is nothing to divide again.

Hence, we have.

128	64	32	16	8	4	2	1	
1	0	1	0	1	1	0	0	
128	+ 0	+32	+0	+8	+4	+0	+0	=172

Thus, the equivalent of  $172_{10}$  in binary number =  $10101100_2$

Now convert 16 to binary using the same method.

Decimal	128	64	32	16	8	4	2	1	
Binary	0	0	0	1	0	0	0	0	
	0	+	0	+	0	+	0	+	0
	16	+	0	+	0	+	0	+	0
									=16

The equivalent of 16 binary number =  $00010000_2$

Now convert 254 to binary number thus;

Decimal	128	64	32	16	8	4	2	1	
Binary	1	1	1	1	1	1	1	0	
	128	+	64	+	32	+	16	+	8
	+	4	+	2	+	0	=254		

The process is as follows

Step 1

$$\begin{array}{r} 1 \\ 128 \overline{) 254} \\ \underline{128} \\ 126 \end{array}$$

Step 2

$$\begin{array}{r} 1 \\ 64 \overline{) 126} \\ \underline{64} \\ 62 \end{array}$$

Step 3

$$\begin{array}{r} 1 \\ 32 \overline{) 62} \\ \underline{32} \\ 30 \end{array}$$

Step 4

$$\begin{array}{r} 1 \\ 16 \overline{) 30} \\ \underline{16} \\ 14 \end{array}$$

Step 5

$$\begin{array}{r} 1 \\ 8 \overline{) 14} \\ \underline{8} \\ 6 \end{array}$$

Step 6

$$\begin{array}{r} 1 \\ 4 \overline{) 6} \\ \underline{4} \\ 2 \end{array}$$

Step 7

$$\begin{array}{r} 1 \\ 2 \overline{) 2} \\ \underline{2} \\ 0 \end{array}$$

The equivalent of 254 in binary number from the seven steps and the table is  $11111110_2$

Now converting 1 to binary number, we have;

Decimal	128	64	32	16	8	4	2	1
Binary	0	0	0	0	0	0	0	1
	0 +	0 +	0 +	0 +	0 +	0 +	0 +	1 =

The equivalent of 172.16.254.1 in binary number is:

10101100.00010000.11111110.00000001

### Rules of IPv6 addressing

In solving problems relating to IPv6 addressing, it is important to understand that IPv6 uses Hexadecimal Number System or employs radix (base) of 16. Digits in Hexadecimal depicts values 0 to 15. Here 0 to 9 is represented with 0 to 9 while 10 to 15 is represented with A to F and thus:

<b>Decimal Number</b>	<b>Binary number</b>	<b>Hexadecimal Number</b>
0	0000	0
1	0001	1
2	0010	2
3	0011	3
4	0100	4
5	0101	5
6	0110	6
7	0111	7
8	1000	8
9	1001	9
10	1010	A
11	1011	B
12	1100	C
13	1101	D
14	1110	E
15	1111	F

Remember, we have discussed some representation of IPv6 when the topic was introduced. Now we will add addendum to it:

**1. Through away leading zero (es)**

2001: 0db8: 0000: 0000: 0000: 8a2e: 0370: 7334

You can discard the leading 0 or 00s by writing:

2001: db8: 0000: 0000: 0000: 8a2e: 370: 7334

**2. In a situation where two or more blocks have a sequential zeroes, discard them all and substitute them with double colon sign (i.e. ::) thus:**

2001: 0db8: 0000: 0000: 0000: 8a2e: 0370: 7334

Can be written as;

2001: 0db8::8a2e: 0370:7334

If there are extra block of zeroes in the address apart from the substituted zeroes with ::, you can reduce them to a single 0.

Let us use another example to illustrate this.

Given:

2001: 0000:3238: DFE1:63:0000:0000: FEFB

Following the process of the previous example of discarding all consecutive zeroes and substituting them with ::, we have

2001:0000:3238: DFE1:63::FEFB

Note that we still have block of zeroes, hence, we need to reduce it to single 0, thus;

2001:0:3238:DFE1:63::FEFB

2. convert 2001:0db8::8a2e:0370:7334 to binary

**Solution**

In case of IPv6, you need to note that IPv6 represents 8 sets of 16 bits where every 4 bits stands for hexadecimal numbers with each group of 16 bits (4 hexadecimal numbers) is distinct from each other with the use of colon (:)

Now to convert 2001:0db8::8a2e: 0370:7334 from hexadecimal to binary, we have;

$$2001 = 0010 \ 0000 \ 0000 \ 0001$$

$$0db8 = 0000 \ 1101 \ 1011 \ 1000$$

$$0000 = 0000 \ 0000 \ 0000 \ 0000$$

$$0000 = 0000 \ 0000 \ 0000 \ 0000$$

$$0000 = 0000 \ 0000 \ 0000 \ 0000$$

$$892e = 1000 \ 1010 \ 0010 \ 1110$$

$$0370 = 0000 \ 0011 \ 0111 \ 0000$$

$$7334 = 0111 \ 0011 \ 0011 \ 0100$$

Therefore 2001: 0db8::8a2e: 0370:7334 in IPv6 hexadecimal number is the same as

$$0010000000000000: \ 0000 \ 110110111000:$$

$$0000000000000000: \ 0000 \ 000000000000:$$

$$0000000000000000: \ 1000 \ 101000101110:$$

$$0000001101110000: \ 0111 \ 001100110100$$

in binary number.

Now, it is time to convert IPv4 to IPv6 and vice versa.

**Questions**

1. Convert 192.168.99.1 in IPv4 to IPv6
2. Convert 2001:0db8:85a3::8a2e: 0370:7334

**Solution**

Let us start by solving the first problem

Covert 192.186.99.1 from IPv4 to IPv6

**Step 1**

Start with 192 by dividing it with 16 (knowing that Hex is base -16)

$$\text{That is, } \frac{192}{16} = 12 \text{ remaining } 0$$

Note that 12 in Hex stands for C and Zero (0) in Hex stands for 0. Therefore, 192 in Hex is **C0**

**Step 2**

Now do the same thing for 168

Divide 168 by 16 (Hex is base -16)

$$\text{That is, } \frac{168}{16} = 10 \text{ remaining } 8. \text{ Since } 16 \times 10 = 160$$

Hence, 10 in Hex stands for A and, 8 in Hex stands for 8

Therefore 168 in Hex stands for A8



### **Step 3**

Next octet to convert using the same problem is 99.

Following the same process  $\frac{99}{16} = 6$  remaining 3.

Since  $6 \times 16 = 96$

Hence 6 in Hex stands for 6

And, 3 in Hex stands for 3

Therefore, 99 in Hex stands for **63**

### **Step 4**

Now converting the last Octet which is 1, we have,  $\frac{1}{16} = 0$  remaining 1

Hence, 0 in Hex stands for 0

And 1 in Hex stands for 1

Therefore, 1 in Hex stands for **01**

Thus, IPv4 address 192.168.99.1 depiction in IPv6 address segment would be C0A8:6301.

This type of address conversion is classified as IPv6 6-to-4 tunnels which in most cases join to form 2002::/16 with the IPv4 Address infused.

The address format of the automatic 6-to-4 tunnels is as follows:

2002:<32 bit IPv4 site address in Hex>:<16 bit network number in Hex>::164. Hence, for IPv4 address of 192.168.99.1, the wrap up of the IPv6 address would be 2002:C0A8:6301::1/64.

Now, let us convert the segment of C0A8:6301 to IPv4.

First, represent the address in the form of IPv4, that is, C0A8:6301 into two (2) tuple-groupings (2 Hex characters) i.e. C0 AB 63 01

Note that any number raised to the power of 0 is 1 and any number raise to the power of 1 is that number.

### **Step 1**

Since IPv6 characters are in base-16, then for the case of C0: C will be multiplied by 16 and 0 multiplied by 1 to convert them to IPv4.

Hence, add the two values together to get the IPv4 decimal value. Thus  $(12 \times 16) + (0 \times 1)$  since C is 12 and 0 is 0 in Hex. This implies  $192 + 0 = 192$

### **Step 2**

Again, take A8 and follow theme process, we have

$(10 \times 16) + (8 \times 1)$  since A =10 and 8=8 in Hex.

Thus,  $160 + 8 = 168$

### **Step 3**

Take 63 and follow the same process, we have  $(6 \times 16) + (3 \times 1)$  since 6 is 6 and 3 is 3 in Hex.

Thus,  $96 + 3 = 99$

#### **Step 4**

Take 01 and follow the same process, we have;

(0x16) + (1x1) since 0=0 and 1=1 in Hex.

Thus, 0 + 1 =1

Therefore, the IPv4 address is 192.168.99.1



#### **4.0 CONCLUSION**

In this concluding unit of this module you have learnt about internetworking protocols. It has also taken you through tunnelling and encapsulation concepts.



#### **5.0 SUMMARY**

In this unit, we defined, a large number of concepts and protocols. Tunnelling is used when the source and destination networks are identical but the network, which lies in between, is different. A subnet allows a network to be split into several parts for Internet use but still acts like a single network to the outside world. It makes management of IP addresses simpler. Another reason for creating a subnet is to establish security between different work groups. Internet is made of a large number of autonomous regions controlled by a different organisation which can, use its own routing algorithm inside. A routing algorithm within an autonomous region (such as LAN, WAN) is called an interior gateway protocol, an algorithm for routing between different autonomous regions are called exterior gateway routing protocols.



#### **6.0 TUTOR MARKED ASSIGNMENT 12**

- 1 List the important features in which one network differs from another.
- 2 What are the mechanisms for interconnecting networks?
- 3 Where is tunnelling used?
- 4 What are the important categories of Network layer protocols?
- 5 List the important OSPF routes and their purposes.
- 6 How is BGP different from other distance vector routing protocols?



#### **7.0 REFERENCES/FURTHER READINGS**

A.S. Tanenbaum, *Computer Networks*, 4<sup>th</sup> Edition, Prentice Hall of India, New Delhi, 2011.

Leon Garcia and Indra Widjaja, *Communication Networks fundamental concepts and key architecture*, Tata McGraw Hill, New Delhi.

Behrouz A. Forouzan, *Data Communication and Networking*, 2nd edition, Tata McGraw Hill, New Delhi, 2016.

Timothy S Ramteke, *Networks, 2nd Edition*, Pearson edition, New Delhi.

## **8.0 ANSWERS TO TUTOR MARKED ASSIGNMENT 12**

### **Question 1**

List the important features in which one network differs from another.

### **Solution**

The reasons why one network differ from another are:

- a. Many personal computers use TCP/IP,
- b. Many larger business organizations still use IBM mainframes with SNA Protocol.
- c. Some PCs still run on Novell's NCP/IPX or Appletalk.
- d. Wireless Network will have different protocols.
- e. A large number of Telecommunication companies provide ATM facilities.

### **Question 2**

What are the mechanisms for interconnecting networks?

The two basic mechanisms for interconnecting networks are concatenated virtual circuit and connectionless interworking in addition to the use of repeaters, switches or hubs and bridges

Explain them

### **Question 3**

Where is tunnelling used?

Tunning is mostly used in virtual private network (VPN) and can be used to connect two networks or use to bypass firewalls.

### **Question 4**

What are the important categories of Network layer protocols?

### **Solution**

The important categories of Network layer protocols are:

- a. Physical layer
- b. Data link layer
- c. Network layer
- d. Transport layer

### **Question 5**

List the important OSPF routes and their purposes.

### Solution

The important OSPF routes are:

- a. Internal routers (within one area).  
They receive traffic within the area or traffic coming from and to other areas.
- b. Area border routers (connects two or more areas).  
They are situated around the boarder and use for linkage between backbone network and the OSPF areas.
- c. Backbone routers (performs routing within the backbone).  
They are used to combined and route traffic from many LAN segments and to uphold **routing** data for thousands of machines
- d. AS boundary routers (exchanges routing information with routers in other ASes).

Read more about this

### Question 6

How is BGP different from other distance vector routing protocols?

### Solution

The main different is that it solves the count to infinity problem

# MODULE 4 TRANSPORT LAYER AND APPLICATION LAYER SERVICES

- Unit 1 Transport Services and Mechanism
- Unit 2 TCP/UDP
- Unit 3 Network Security I
- Unit 4 Network Security II

## UNIT 1 TRANSPORT SERVICES AND MECHANISM

### CONTENTS

- 1.0 Introduction
- 2.0 Objectives
- 3.0 Main Content
  - 3.1 Transport Services
    - 3.1.1 Types of Services
    - 3.1.2 Quality of Service
    - 3.1.3 Data Transfer
    - 3.1.4 Connection Management
    - 3.1.5 Expedited Delivery
  - 3.2 Elements of Transport Layer Protocols
    - 3.2.1 Addressing
    - 3.2.2 Multiplexing
    - 3.2.3 Flow Control and Buffering
    - 3.2.4 Connection Establishment
    - 3.2.5 Crash Recovery
- 4.0 Conclusion
- 5.0 Summary
- 6.0 Tutor-Marked Assignment
- 7.0 References/Further Readings



### 1.0 INTRODUCTION

The transport layer is the core of the OSI model. It is not just another layer but the heart of the whole protocol hierarchy. Protocols at this layer oversee the delivery of data from an application program on one device to an application program on another device. It is the first end-to-end layer in the OSI model. It provides its services to the upper layer to use the services of the network layer and other lower layer protocols.

You must be aware that an Internet is comprised of several physical networks such as the LANs, MANs, and WANs that are connected together through a variety of media (wired as well wireless) to facilitate the transfer of data from a computer on one network to another computer on another network. As a transmission moves from one network to another, the data on the way may be transformed i.e., it may be encapsulated in different types and lengths of packets.

The upper-layer protocols are unaware of the intricacy of the physical networks the transport layer **provides** to the upper layers, the individual physical networks are a simple homogeneous network that somehow takes data and delivers it to its destination, reliably. For example, even if an Ethernet in the LAN part of internet is replaced by a FDDI, the upper layers remain unaware of it. To them, the Internet is a single and essentially unchanging network. The transport layer provides this transparency.

Examples of transport layer protocols are Transmission Control Protocol (TCP) and User Datagram Protocol (UDP).

In this unit, we will first discuss types of services we might expect from a transport layer. Next, we will examine several mechanisms to support these services.



## 2.0 OBJECTIVES

After going through this unit, you 'should be able to:

- 1 list and describe transport services list and
- 2 describe transport mechanisms.



## 3.0 MAIN CONTENT

### 3.1 Transport Services

We begin by looking at the kinds of services that a transport protocol can or should provide to upper layer protocols. **Figure 4.1** outlines the environment for transport services. There is a transport entity that provides services to the upper layer users, which might be an application process such as http, telnet etc. This local transport entity communicates with some remote-transport entity, based on the services provided by the network layer.

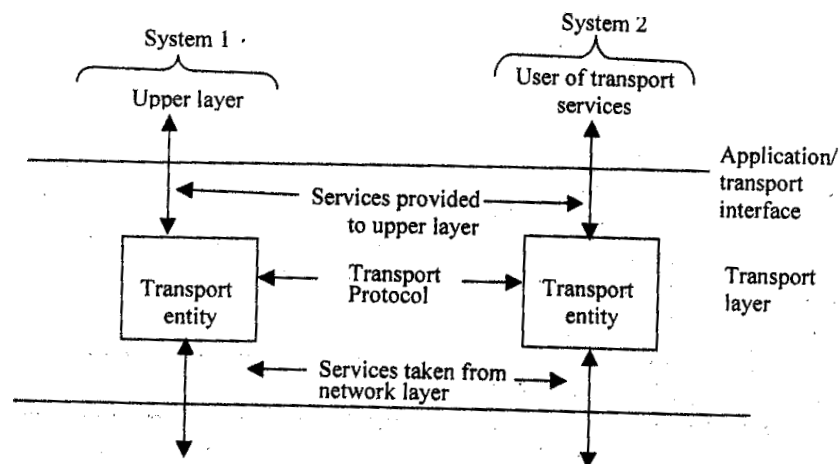

Figure 4.1: Transport entity environment

As discussed earlier the general service provided by a transport protocol is the end-to-end transport of data in a way that shields the upper layer user from the details of the underlying networks infrastructure. The following categories of services are generally used for describing the services provided by the transport layers.

- 1 Types of services
- 2 Quality of service
- 3 Data transfer
- 4 Connection management
- 5 Expedited delivery

### 3.1.1 Types of Services

There are generally two basic types of services: (i) Connection-oriented and (ii) Connectionless, or datagram services provided by the Internet. A connection-oriented service is the most common type of protocol service available. It provides the establishment, maintenance, and termination of a logical connection between users. This is also **called handshaking** procedures. The connection-oriented service generally implies that the service is reliable which includes features such as flow control, error control and sequence delivery. Flow control makes sure that neither side of a connection overwhelms the other side by sending **too many** packets too quickly.

#### Connection-Oriented

The Internet connection-oriented service is accomplished using TCP (Transmission Control Protocol). Reliable transport, flow control and congestion control are types of services that are provided to an application by TCP. These services are acknowledged. The TCP's congestion control mechanism is used to maintain throughput.

#### Connectionless Service

There is no handshaking here before sending the packet. There are also no flow control and congestion control mechanisms. Since there is no handshaking procedure, data can be transferred faster. But there is no reliable data transfer either as these services are not acknowledged. The Internet's connectionless service is called UDP (User Datagram Protocol). Some of the applications of **connectionless service** are internet telephony and video conferencing.

The connection-oriented transport service is similar to the connection-oriented network service. So, the question is, why do we require two different layers to provide the same type of service. The answer to this question is that the transport code runs on the user's machine whereas the network layer runs mostly on the routers, which are controlled by the carrier which provide poor service. Therefore, the only possibility is to put another layer on top of the network layer, that improves the quality of service.

It is due to the transport layer that application programmers can write programs according to standard sets of library procedure calls and have these programs run on

networks without worrying about dealing with different subnet interfaces and unreliable transmission.

Thus, there is a place at the transport level for both a connection- oriented and a connection less type of service.

### 3.1.2 Quality of Service

The transport protocol entity should allow the upper layer protocol users to specify the types of quality of transmission service to be provided. Based on these specifications the transport entity attempts to optimise the use of the underlying link, network, and other resources to the best of its ability, so as to provide the collective requested services. But these services are limited to the **Internet** capabilities of the network layer services.

Examples of services that might be requested are:

- 1 Expedited delivery of packet
- 2 Acceptable error and loss levels of packet
- 3 Desired average and maximum delay in transmission of a packet
- 4 Desired average and minimum throughput
- 5 Priority levels.

You are aware that IP is a standard protocol for the network layer. IP does provide a quality-of-service parameter such as priority as well as a binary specification for normal or low delay, normal or high throughput, and normal or high reliability. Thus, the transport entity can make a request to the internetwork entity. The network may alter flow control parameters and the amount of network resources allocated on a virtual circuit to achieve desired throughput. The transport layer may also split one transport connection among multiple virtual circuits to enhance throughput. This will be explained in section 3.2.2.

You must be aware that different applications may require different quality of services. For example:

- 1 A file transfer protocol might require high throughput. It may also require high reliability to avoid retransmissions at the file transfer level.
- 2 A transaction protocol (e.g., web browser-web server) may require low delay.
- 3 An electronic mail protocol may require multiple priority levels.

One approach to providing a variety of qualities of service is to include a quality-of-service facility within the protocol; the transport protocols typically follow the same approach. An alternative is to provide a different transport protocol for different classes of traffic; this is to some extent the approach taken by the ISO-standard family of transport protocols:

An application layer protocols need from the Transport layer [Ref.2]. These are:

- 1 Reliable data transfer
- 2 Bandwidth



### 3 Timing/delay.

#### 1 Reliable data transfer

By reliable data transfer means that there is not a single bit of loss of data during transmission. There are certain types of application, which does not tolerate any loss of data, such as financial applications. In particular, a loss of file data, or data in a financial transaction, can have devastating consequences (in the latter case, for either the bank or the customer). Other applications in the category are transfer of web documents, electronic mail, file transfer and remote host access. But there are some applications which can tolerate some amount of data loss.

For example, multimedia applications such as real-time audio/video. In these multimedia applications, lost data might result in a small glitch while playing the audio/video, the effects of such a loss on application quality and actual amount of tolerable packet loss, will depend strongly on the application and the coding scheme used.

#### 2 Bandwidth

The concept of bandwidth has been explained in the first block. Just to recall, the higher the bandwidth the more the channel capacity. There are certain applications, which are **bandwidth sensitive**. For example, the Internet telephony, requires a given amount of bandwidth. But there are some other types of application called elastic application which can make use of as much or as little bandwidth as happens to be available. Electronic mail, file transfer, and Web transfers are all elastic application [Ref.2] of course; the more bandwidth, and the better would be transport capacity.

#### 3 Timing/delay

The final service requirement is that of timing. There are certain applications, which require tight timing constraints on data delivery in order to be effective. For example, interactive real-time applications, such as Internet telephony, virtual environments, teleconferencing, and multiplayer games. Many of these applications require that end-to-end delays be on the order of a few hundred milliseconds or less. Long delays in Internet telephony, and a long delay between taking an action and judging the response from the environment in a multiplicity game tends to result in unnatural pauses in the conversation.

### 3.1.3 Data Transfer

The whole purpose, of course, of a transport protocol is to transfer data between two transport entities. Both user data and control data must be transferred from one end to the other end either on the same channel or separate channels. Full-duplex service must be provided. half-duplex and simplex modes may also be offered to support peculiarities of particular transport users.

Here, you may ask the question if the network layer does a similar task, why it is necessary at the transport layer. The network layer oversees the hop by hop delivery of the individual packet but does not see any relationship between those packets even those belonging to a single message. Each packet is treated as an independent entity. The transport layer on the other hand makes sure that not just a single packet but the entire sequence of packets.

### 3.1.4 Connection Management

When connection-oriented service is provided, the transport entity is responsible for establishing and terminating connections. Both symmetric and asymmetric procedure for connecting establishment may be provided.

Connection termination can be either *abrupt* or *graceful*. With an abrupt termination, data in transit may be lost. A graceful termination prevents either side from shutting down until all data has been delivered.

### 3.1.5 Expedited Delivery

A service similar to that provided by priority classes is the expedited delivery of data. Some data submitted to the transport service may supersede data submitted previously. The transport entity will endeavour to have the transmission facility transfer the data as rapidly as possible. At the receiving end, the transport entity will interrupt the transport service user to notify it of the receipt of urgent data. Thus, the expedited data service is in the nature of an interrupted mechanism, and is used to transfer occasional urgent data, such as a break character from a terminal or an alarm condition. In contrast, a priority service might dedicate resources and adjust parameters such that, on average, higher priority data are delivered more quickly.

## 3.2 Elements of Transport Layer protocols

The services provided by the transport layer are implemented by the transport layer protocols such as TCP and UDP. We will talk about them in the next unit. In this section, we will take up important components of the transport layer for discussion. A transport layer deals with hop-by-hop processes.

### 3.2.1 Addressing

The issue concerned with addressing is simply this-how a user process will set up a connection to a remote user process? How the address of a remote process should be specified? The method generally used is to define transport address to which the process can listen for connection requests. In Internet jargon, these end points are called **port or TSAP** (Transport Services Access Points). Similarly, these end points at the network layer are then called NSAP (Network Services Access Points). The following illustration (Figure 4.2) shows the connection between a user processes as host 1 with a remote process (server) as host 2.

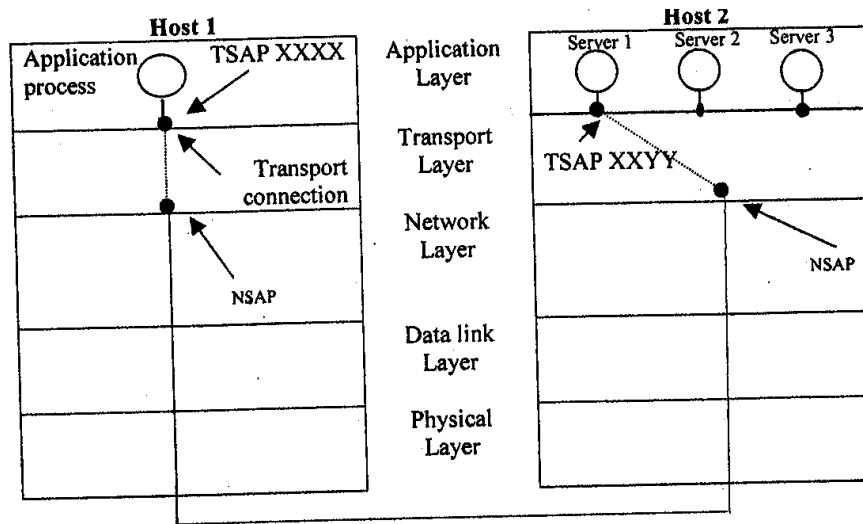

Figure 4.2: Transport connections between a client and a server

The following steps may be needed for establishing a transport connection [Ref. 1]:

- 1 Just assume that an application process running on I wants to find out the next day's weather forecast, so, it issues a CONNECT request specifying its transport connection point number TSAP XXXX as well as the TSAP number XXYY of the weather forecasting server which will establish transport connection with the destination. This action ultimately results in a transport connection between the application process on host I and a server 1 on host 2.
- 2 Assume that a weather forecasting server is attached to a transport connection at XXYY.
- 3 The application process then sends a request for the next 10 days weather report.
- 4 The weather server process responds with the current weather report.
- 5 The transport connection is then released.

The question, that needs to be addressed: How does the host user know that the address of the destination server process is attached to a particular transport connection? To resolve this issue various strategies are suggested [Refer 1]:

- 1 **Initial connection protocol:** In the scheme a process server acts as a proxy server for less heavily used servers. Instead of every server listening at a well known port address waiting for a connection request; a process server listens to sets of ports at the same time and informs a particular server to act upon getting a connecting request to perform the required work. The new server then does the request work, while the process server goes back to listening for new request. Therefore, through a process server a rarely used server should not be listening to ports all the time.

- 2 Some commonly used services are assigned “well-known address” (for example, time sharing and word processing).
- 3 A name server or sometimes a directory server is provided. The Transport Service user requests a service through some generic or global name. The request is sent to the name server, which does a directory lookup and returns an address. The transport entity then proceeds with the connection. This service is useful for commonly used applications that change location from time to time. It is also used for those stations in which services do exist independently of a process server. For example, a file server that needs 10 run on a special hardware (a machine with disk) that cannot be created dynamically when someone want to talk to it [Ref. 1].

### 3.2.2 Multiplexing

The transport entity may also perform a multiplexing function with respect to the network services that it uses. There are two types of multiplexing techniques that define **upward multiplexing** as the multiplexing of multiple transport connections on a single network connection, and downward multiplexing as the splitting of a single transport connection among multiple lower-level connections. This is illustrated in [Figure 4.3](#)

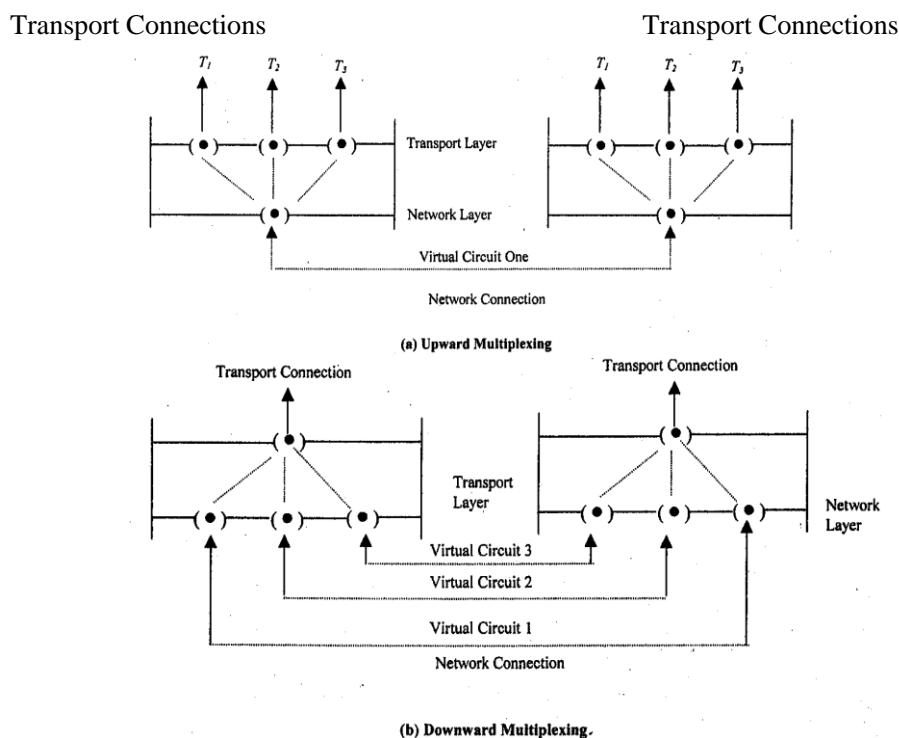

Figure 4.3: Multiplexing

Consider, for example, a transport entity making use of an **X.25** service. X.25 is a network layer protocol like IP. Why should the transport entity employ upward multiplexing? There are, after all, 4905 virtual circuits available. In the typical case, this is a more than enough to handle all active Transport Service user. However, most X.25 networks base part of their charge on virtual-circuit connect time, as each virtual circuit consumes some node buffer resources. Thus, if a single virtual circuit provides

sufficient throughput for multiple TS users, upward multiplexing may be used [Figure 4.3].

On the other hand, **downward multiplexing** or splitting might be used to provide more bandwidth than a single Virtual Circuit can manage. A way out is to open multiple network connections and distribute traffic among them on a round-robin basis, as indicated in Figure 4.3. This modus operandi is called **downward multiplexing**. With network connections open, the effective bandwidth is increased by a factor of  $k$ . A common example of downward multiplexing occurs with home users who have an **Integrated Service Digital Network (ISDN)** line. This line provides for two separate connections of 64 kbps each. Using both of them to call an Internet provider and dividing the traffic over both lines makes it possible to achieve an effective bandwidth of 128 kbps.

### 3.2.3 Flow Control and Buffering

There are similarities as well as differences between data link layer and transport layer in order to support flow control mechanism. The similarity is in using the sliding window protocol. The main difference is that a router usually has relatively few lines, whereas a host may have numerous connections. Due to this reason it is impractical to implement the data link buffering strategy in the transport layer.

Whereas flow control is a relatively simple mechanism at the data link layer, it is a rather complex mechanism at the transport layer, for two main reasons:

- 1 Flow control at the transport level involves the interaction of three components: TS users, transport entities, and the network service.
- 2 The transmission delay between transport entities is variable and generally long compared to actual transmission time.

The following delay may arise during the interaction of the two transport entities A and B:

- 1 Waiting time to get permission from its own transport entity (interface flow control).
- 2 Waiting time by A to have permission to send the data to B.
- 3 Waiting time as network layer services.

In any case, once the transport entity has accepted the data, it sends out a segment. Sometime later, it receives an acknowledgement that the data has been received at the remote end. It then sends a confirmation to the sender.

Now let us come to the flow control problem.

First, we present two ways of coping with the flow control requirement [Ref.3] by using a fixed sliding-window protocol and by using a credit scheme.

The first mechanism is already familiar to us from our discussions of data link layer protocols. The key ingredients are:

- 1 The use of sequence numbers on data units.
- 2 The use of a window of fixed size.
- 3 The use of acknowledgements to advance the window.

This scheme really works well. For example, consider a protocol with a window size of 3. Whenever the sender receives an acknowledgement from a particular segment, it is automatically authorised to send the succeeding seven segments. (Of course, some may already have been sent). Now, when the receiver's buffer capacity comes down to 7 segments, it can withhold acknowledgement of incoming segments to avoid overflow. The sending transport entity can send, at most, seven additional segments and then must stop. Because the underlying network service is reliable, the sender will not time-out and retransmit. Thus, at some point, a sending transport entity may have a number of segments outstanding, for which no acknowledgement has been received. Because we are dealing with a reliable network, the sending transport entity can assume that the segments will come through and that the lack of acknowledgement is a flow control tactic. Such a strategy would not work well in an unreliable network, as the sending transport entity would not know whether the lack of acknowledgement is due to flow control or a lost segment.

The second alternative, a credit scheme, provides the receiver with a greater degree of control over data flow.

The credit scheme decouples acknowledgement from flow control. In fixed sliding-window protocols, used as the data **Link** layer, the two are synonymous. In a credit scheme, a segment may be acknowledged without granting a new credit, and vice versa. **Figure 4.4** illustrates the protocol. For simplicity, we have depicted data flow in one direction only. In this example, data segments are numbered sequentially module 8 (e.g., SN 0 = segment with sequence number 0). Initially, through the connection-establishment process, the sending and receiving sequence numbers are synchronised, and A is granted a credit allocation of 7. "A" advances the trailing edge of its window each time that it transmits, and advances the leading edge only when it is granted a credit.

**Figure 4.4** shows a view of this mechanism from the sending and receiving sides; of course, both sides take both views because data may be exchanged in both directions.

From the receiving point of view, the concern is for received data and for the window of credit that has been allocated. Note that the receiver is not required to immediately acknowledge incoming segments, but may wait and issue a cumulative acknowledgement for a number of segments; this is true for both TCP and the ISO transport protocol.

In both the credit allocation scheme and the sliding window scheme, the receiver needs to adopt some policy concerning the amount of data it permits the sender to transmit. The conservative approach is only to allow new segments up to the limit of available **buffer** space.

A conservative flow control scheme may limit the throughput of the transport connection in long-delay situations. The receiver could potentially increase

throughput by optimistically granting credit for space it does not have. This is called dynamic **buffer** allocation scheme. For example, if a receiver's **buffer** is full but it anticipates that it can release space for two segments within a round-trip propagation time, it could immediately send a credit of 2. If the receiver can keep up with the sender, this scheme may increase throughput and can do no harm. If the sender is faster than the receiver, however, some segments may be discarded, necessitating a retransmission. Because retransmissions are not otherwise necessary with a reliable network service, an optimistic flow control scheme will complicate the protocol.



(a) Initial window size

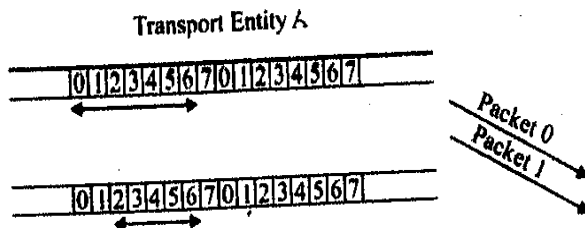

(b) Status of sender's window after transfer of 2 packets

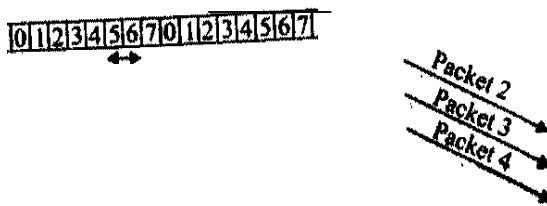

(c) Status of sender's window after transfer of 3 more packets

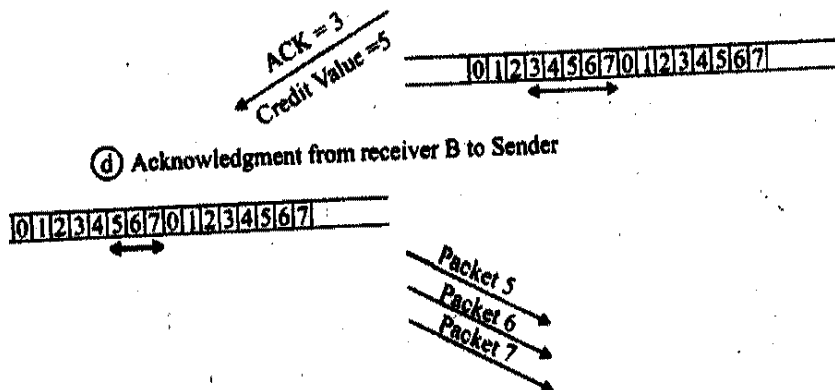

(d) Acknowledgment from receiver B to Sender

(e) Adjustment of each window with credit



(f) No remaining credits for A

Transport Entity B .

.,!.

C . -.t' >' --- C  
0 1 2 3 4 5 6 7 0 1 2 3 4 5 6 7

@ Acknowledgment of S segments by receiver  
Transport Entity A

lol!1213141sl6!7!o! ti213!4ISI617!

Ⓜ.Sender receives a new credit

Figure 4.4: Flow control and buffering

The optimum trade-off between source buffering and destination buffering depends on the type of traffic carried out by the connection. For low bandwidth busy traffic, such as that produced by an interactive terminal. It is better not to dedicate any **buffer**, but rather to acquire them dynamically at both ends. Since the sender cannot be sure the receiver will be able to acquire a buffer, the sender must retain a copy of the TPDU (Transport Protocol Data Unit) until it is acknowledged. On the other hand, for file transfer and other high bandwidth traffic, it is better if the receiver dedicates a full window of buffers, to allow the data to flow at maximum speed. Thus, for low-bandwidth bursty traffic, it is better to buffer at the sender, and for high-bandwidth smooth traffic, it is better to buffer at the receiver

As connections are opened and closed and as the traffic pattern changes, the sender and receiver need to dynamically adjust their buffer allocations. **Consequently**, the transport protocol should allow a sending host to request buffer space at the other end. Buffers could be allocated per connection, or collectively, for all the connections running between the two hosts. Alternatively, the receiver, knowing its buffer station (but not knowing the offered traffic) could tell the sender “I have reserved X buffers for you”. If the number of open connections should increase, it may be necessary for an allocation to be reduced, so the protocol should provide for this possibility.

In summary, a reasonably general way to manage dynamic buffer allocation is to decouple the buffering from the acknowledgements, in contrast to the sliding window protocols of data link layer.

### 3.2.4 Connection Establishment

End-to-end delivery can be accomplished in either of two modes: connection-oriented or connectionless. Of these two, the connection-oriented mode is the more



commonly used. A connection-oriented protocol establishes a virtual circuit or pathway through the Internet between the sender and receiver. All of the packets belonging to a message are then sent over this same path. Using a single pathway for the entire message facilitates the acknowledgement process and retransmission of damaged or lost frames. Connection-oriented services, therefore, are generally considered reliable.

Connection-oriented transmission has three stages: connection establishment, data transfer, and connection termination.

The network is generally unreliable and congested. Even with a reliable network service, there is a need for connection establishment and termination -procedures to support connection-oriented service.

Connection establishment serves three main purposes:

1. It allows each end to assure that the other exists.
2. It allows negotiation of optional parameters (e.g., minimum segment size, maximum window size, quality of service).
3. It triggers allocation of transport entity resources (e.g., buffer space, entry in connection table).

To solve the problems arising out of unreliable and congested networks 3-way handshake procedure is used to establish transport connection, which is generally comprised of three steps.

1. Connection initiation requirement
2. Connection confirmation
3. Acknowledgement of confirmation and data transfer.

### 3.1.5 Crash Recovery

Similar to the database this is an important issue in computer network. In a network a host as well as a router can crash. Therefore, the issue is its recovery. In case of the loss of Virtual Circuit (In case the network layer provides connection-oriented service) due to a crash delivery, a new virtual circuit may be established then probing the transport entity to ask which TPDU it has received and which one it has not received so that the latter can be retransmitted. In case of datagram subnet, the frequency of the lost TPDU is high but the network layer knows how to handle that. The real problem is the recovery from the host crash. Students are requested to read Computer Network by Tanenbaum on this method and also to relate to how a similar problem is resolved in the database (MCS-043).



## 4.0 CONCLUSION

In this unit you have learnt about transport services mechanism which comprise types of transport services, quality of service data transfer mechanism, connection establishment, multiplexing and finally flow control and buffering.



## 5.0 SUMMARY

In this unit, we have discussed two important components with respect to transport layer namely, transport services and the elements of transport layer protocols. As a part of transport services, we discussed type of services, quality of services, connection mechanism. We also outlined three types of services provided by the transport layer through the applications layer. We listed the various types of protocols (applications layer) and the kind of services. We also differentiated between the data link layer and transport layer with respect to flow control mechanism. Similarly, we also differentiated between two types of multiplexing mechanism at the transport layer.



## 6.0 TUTOR MARKED ASSIGNMENT 13

1. List the three types of services provided by Transport layer to Applications layer.
2. Describe the presence of data loss and time sensitiveness for the following applications:
  - a. File Transfer
  - b. E-mail
  - c. Web surfing
  - d. **Real time** audio/video.
3. List the important multiplexing mechanism at the Transport Layer and also U explain how they are different from each other.



## 7.0 REFERENCES/FURTHER READINGS

A. S. Tanenbaum, *Computer Networks*, 4th Edition. Prentice Hall of India, New Delhi, 2011.

James Kurose and Keith W. Ross, *Computer Networking. A Top down approach featuring the Internet*, Pearson education, New Delhi.

William Stallings, *Data and Computer communication*. 6<sup>th</sup> Edition, Pearson Education, New Delhi, 2003.

## 8.0 ANSWERS TO TUTOR MARKED ASSIGNMENT 13

### Question 1

List the three types of services provided by Transport layer to Applications layer.

The services are:

- a. Quality of service
- b. Data transfer
- c. Connection management
- d. Expedited delivery

### Question 2

Describe the presence of data loss and time sensitiveness for the following applications:

- a File Transfer
- b E-mail
- c Web surfing
- d Stored audio/video.

### **Solution**

- a. *File Transfer*: File transfer is conscious of data loss and so it needs to be error free. Hence, it is pertinent for the file to be error free in transmission rather than been fast in transmission.
- b. *E-Mail*: this is not delay sensitive. If the delays are uniform within a few seconds, there will be no harm. Email does not need much bandwidth to operate.
- c. *Web surfing*: this is delay sensitive.
- d. *Real-time audio/video*: here loss of data might result in small glitch while playing the video, the effect of such loss on application quality and actual amount of tolerable loss will depend strongly on the application and the coding scheme used. Video and audio use a lot of bandwidth and are extremely sensitive to jitter. For audio jitter of a few milliseconds is clearly audible.

### **Question 3**

List the important multiplexing mechanism at the Transport Layer and also U explain how they are different from each other.

### **Solution**

The important multiplexing mechanism at the transport are:

- a. Upward multiplexing
  - b. Downward multiplexing
- Explain the difference between them.

## UNIT 2 TCP/UDP

### CONTENTS

- 1.0 Introduction
- 2.0 Objectives
- 3.0 Main Content
  - 3.1 Services Provided by Internet Transport Protocols
    - 3.1.1 TCP Services
    - 3.1.2 UDP Services
  - 3.2 Introduction to UDP
  - 3.3 Introduction to TCP
  - 3.4 TCP Segment Header
  - 3.5 TCP Connection Establishment
  - 3.6 TCP Connection Termination
  - 3.7 TCP Flow Control
  - 3.8 TCP Congestion Control
  - 3.9 Remote Procedure Call
- 4.0 Conclusion
- 5.0 Summary
- 6.0 Tutor-Marked Assignment
- 7.0 References/Further Readings



### 1.0 INTRODUCTION

In the previous unit, we discussed the fundamentals of the transport layer which covered topics related to the quality of services, addressing, multiplexing, flow control and buffering. The main protocols which are commonly used such as TCP (Transmission Control Protocol and UDP (User Datagram Protocol) were also discussed. TCP is the more sophisticated protocol of the two and is used for applications that need connection establishment before actual data transmission. Applications such as electronic mail, remote terminal access, web surfing and file transfer are based on TCP.

UDP is a much simpler protocol than TCP because, it does not establish any connection between the two nodes. Unlike TCP, UDP does not guarantee the delivery of data to the destination. It is the responsibility of application layer protocols to make UDP as reliable as possible.

In this unit, we will go into details on these two protocols.



### 2.0 OBJECTIVES

After going through this unit, you should be able to:

- 1 list and explain the various services provided by the Transport Layer
- 2 establish and release TCP connections
- 3 describe TCP and UDP header formats
- 4 describe TCP Flow Control mechanism and how it is different from data link layer
- 5 discuss the Congestion mechanism in TCP.



## 3.0 MAIN CONTENT

### 3.1 Services Provided by Internet Transport Protocols

The Internet provides two service models: TCP and UDP. The selection of a particular service model is left to the application developers. TCP is a connection oriented and reliable data transfer service whereas UDP is connectionless and provides unreliable data transfer service.

#### 3.1.1 TCP Services

When an application invokes TCP for its transport protocol, the application receives the following services from it:

- 1 Connection oriented service
- 2 Reliable transport service
- 3 Congestion-control mechanism.

Now let us describe these services in brief:

#### Connection-oriented service

As you are aware from your understanding of the previous unit that the connection-oriented service is comprised of the handshake procedure which is a full duplex connection in that, two processes can send messages to each other over the connection at the same time. When the application has finished sending the message, it must remove the connection. The service is referred to as a “connection oriented” service. We are also aware from the discussion on the network layer that this service is implemented through the virtual circuit mechanism.

#### Reliable Transport Service

Communicating processes can rely on TCP to deliver all the data that is sent, without error and in the proper order. When one side of the application passes a stream of bytes into a socket, it can count on TCP to deliver the same stream of data to the receiving socket, with no missing or duplicate bytes. Reliability in the Internet is achieved with the use of acknowledgement and retransmissions.

Congestion-control mechanism: TCP also includes a congestion-control mechanism for the smooth functioning of Internet processes. When the packet load offered to the network exceeds its handling capacity congestion builds up.

One point to be noted is that, although, the Internet connection-oriented service is bundled with suitable data transfer, flow control and congestion control mechanisms, they are not the essential components of the Connection oriented service [Ref. 2].

A connection-oriented service can be provided with bundling these services through a different type of a network.

Now we will look at the services TCP does not provide? Some of these are:

- 1 It does not guarantee a minimum transmission rate,
- 2 It does not provide any delay guarantee. But it guarantees delivery of all data.

However, it provides no guarantee to the rate of data delivery.

### 3.1.2 UDP Services

Some of the important features of UDP are as follows:

- 1 UDP is connection less, so there is no hand shaking before the two processes start communications.
- 2 It provides unreliable data transfer service therefore, there is no guarantee that the message will reach. Due to this, the message may arrive at the receiving process at a random time.
- 3 UDP does not provide a congestion-control service. Therefore, the sending process can pump data into a UDP socket at any rate it pleases. Then, why do we require such a protocol at the transport layer? There are certain types of applications such as real time. Real-time applications are applications that can tolerate some loss but require a minimum rate. Developers of real-time applications often choose to run their applications over the UDP because their applications cannot wait for acknowledgements for data input. Now coming back to TCP, since it guarantees that all the packets will be delivered to the host, many application protocols, layer protocols are used for these services. For example, SMTP (E-mail), Telnet, **HTTP**, FTP exclusively uses TCP whereas NFS and Streaming Multimedia may use TCP or UDP. But Internet telephony uses UDP exclusively.

## 3.2 Introduction to UDP

So, you might have guessed from the previous section, that UDP is an unreliable transport protocol. Apart from multiplexing/demultiplexing and some error correction UDP adds little to the IP protocol. In this section, we take a look at UDP, at how it works and at what it does.

In case, we select UDP instead of TCP for application development, then the application is almost directly talking to the IP layer. UDP takes messages from the

application process, attaches the source and destination port number fields for the multiplexing/demultiplexing service, adds two other small fields, and passes the resulting segment to the network layer. Without establishing handshaking between sending and receiving transport-layer entities, the network layer encapsulates the segment into an IP datagram and then makes a best-effort attempt to deliver the segment to the receiving host. If the segment arrives at the receiving host, UDP uses the destination port number to deliver the segment's data to the desired application process.

So, you might ask a question then why is UDP required? TCP should be the choice for all types of application layer/protocol. DNS stands for domain name system. It provides a directory service for the internet. It is commonly used by other application protocols (HTTP, FTP etc.) to translate user given host names to IP address. But before we answer your question let-us look at another application called the DNS, which runs exclusively in UDP only but unlike other protocols DNS is not an application with which users interact directly. Instead DNS is a core Internet function that translates the host name to IP addresses. Also, unlike other protocols, DNS typically uses UDP. When the DNS application in a host wants to make a query, it constructs a DNS query message and passes the message to the UDP. Without performing any handshaking with the UDP entity running on the destination end system, UDP adds header fields to the message and passes the resulting segment to the network layer. The network layer encapsulates the UDP segment into a datagram and sends the datagram to a name server. The DNS application at the querying host then waits for a reply to its query. If it doesn't receive a reply (possibly because the underlying network lost the query or the reply), either it tries sending the query to another name server, or it informs the invoking application that it can't get a reply.

Like DNS, there are many applications, which are better suited for UDP for the following reasons [Ref2]:

### **No Connection Establishment**

Since UDP does not cause any delay in establishing a connection, this is a probably the principal reason why DNS runs over UDP rather than TCP-DNS which would be much slower if it runs over TCP. **HTTP** uses TCP rather than UDP, since reliability is critical for Web pages with text.

### **More Client Support**

TCP maintains connection state in the end systems. This connection state includes receiving and sending buffers, congestion-control parameters, and sequence and acknowledgement number parameters. We will see in Section 3.5 that this state information is needed to implement TCP's reliable data transfer service and to provide congestion control. UDP, on the other hand, does not maintain connection state and does not track any of these parameters. A server devoted to a particular application can typically support many more active clients when the application runs over UDP rather than TCP. Because UDP, (unlike TCP) does not provide reliable data service and congestion control mechanism, therefore, it does not need to maintain and track the receiving and sending of buffers (connection states),

congestion control parameters, and sequence and acknowledgement number parameters.

Small packet header overhead. The TCP segment has 20 bytes of header overhead in every segment, whereas UDP has only eight bytes of overhead.

Now let us examine the application services that are currently using the UDP protocol. For example, remote file server, streaming media, internet telephony, network management, routing protocol such as RIP and, of course, DNS use UDP. Other applications like e-mail, remote terminal access web surfing and file transfer use TCP. Please see reference [2] for further details.

Before discussing the UDP segments structure, now, let us try to answer another question. Is it possible to develop a reliable application on UDP? Yes, it may be possible to do it by adding acknowledgement and retransmission mechanisms, at the application level. Many of today's proprietary streaming applications do just this - they run over UDP, but they have built acknowledgements and retransmissions into the application in order to reduce packet loss. But you understand that it will lead to complete application software design.

### UDP Segment Structure

UDP is an end to end transport level protocol that adds only port addresses, checksum error control and length information to the data from the upper layer.

The application data occupies the data field of the UDP segment. For example, for DNS, the data field contains either a query message or a response message. For a streaming audio application, audio samples fill the data field. The packet produced by UDP is called a user datagram.

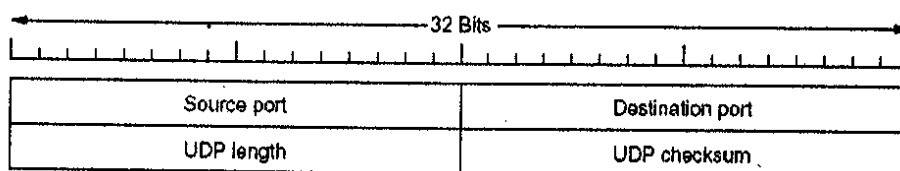

Figure 4.5: UDP segment structure

The UDP header has only four fields, each consisting of two bytes [Figure 4.5]. Let us discuss each field separately:

#### Source port address

It is the address of the application program that has created the message.

#### Destination port address

It is the address of the application program that will receive the message.

#### Total length



It specifies the length of UDP segment including the header in bytes.

Checksum: The checksum is used by the receiving host to check whether errors have been introduced into the segment. In truth, the checksum is also calculated over a few of the fields in the IP header in addition to the UDP segment.

### 3.3 Introduction to TCP

TCP is designed to provide reliable communication between pairs of processes (TCP users) across a variety of reliable and unreliable networks and Internets. TCP is stream oriented (Connection Oriented). Stream means that every connection is treated as stream of bytes. The user application does not need to package data in individual datagram as it is done in UDP. In TCP a connection must be established between the sender and the receiver. By creating this connection, TCP requires a VC at IP layers that will be active for the entire duration of a transmission. The data is placed in allocated buffers and transmitted by TCP in segments. In addition, TCP provides two useful facilities for labelling data, push and urgent:

[When the PSH (data push) bit is set, this is an indication that the receiver should pass the data to the upper layer immediately. The URG (Urgent) bit is used to indicate that there is data in this segment that the sending side upper layer entity has marked as urgent. The location of the last byte of this urgent data is indicated by the 16 bit urgent data pointer field 7).

Both IP and UDP treat multiple datagrams belonging to a single transmission as entirely separate units, un-related to each other. TCP on the other hand is responsible for the reliable delivery of entire segments. Every segment must be received and acknowledged before the VC is terminated.

### 3.4 TCP Segment Header

TCP uses only a single type of protocol data unit, called a TCP segment. The header is shown in [Figure 4.6](#). Because one header must perform all protocol mechanisms, it is rather large, with a minimum length of 20 octets. A segment beginning with 9 fixed format 20 byte headers may be followed by header option [Ref. I]. After the options, if any, up to  $65,535 - 20$  (IP header)  $-$  (TCP header) = 65,445 data bytes may follow. A Segment with no data is used, for controlling messages and acknowledgements.

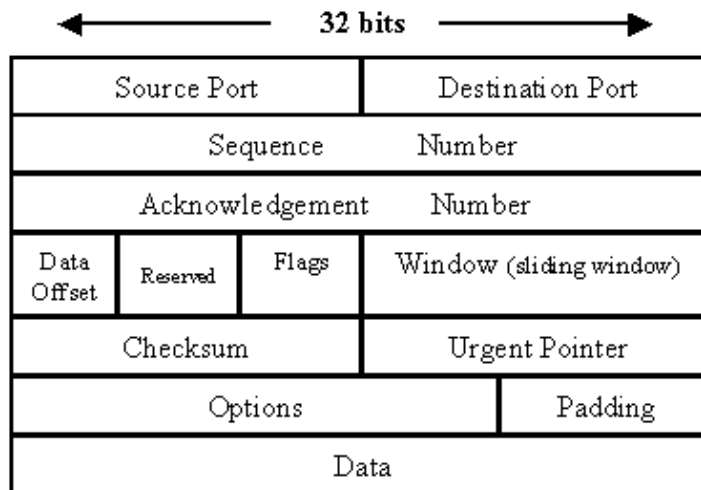

Figure 4.6: TCP header format

The fields are:

**Source port (16 bits)**

Source service access points and identify local end points of connection.

**Sequence number (32 bits)**

Sequence number of the first data octet in this segment except when SYN is present. If SYN is present, it is the initial sequence number (ISN), and the first data octet is ISN+1.

**Acknowledgement number (32 bits)**

A piggybacked acknowledgement contains the sequence number of the next byte that the TCP entity expects to receive and not for last byte correctly received. Separate number field and acknowledgement number fields are used by the TCP sender and the receiver has to implement a reliable data service.

**Data offset (4 bits)**

Number of 32-bit, words in the header.

**Reserved (6 bits)**

Reserved for future use.

**Flags (6 bits):**

URG: Used to indicate that there is data in this segment which sends the data at the upper layer has marked urgent. The location of the last byte of this urgent data is indicated by the 16 bit urgent data pointer field. ACK: Acknowledgement field indicates that the value carried in the ACK field is valid.

PSH: Push function. The receiver is represented to deliver the data to the application upon arrival, and not buffer it until a full buffer has been received.

RST: Reset the connection due to host crash or some other reason.

SYN: Synchronise the sequence numbers.

FIN: No more data from sender.

### **Receive Window (16 bits)**

Used for credit based flow control scheme, in bytes. Contains the number of data bytes beginning with the one indicated in the acknowledgement field that the receiver is willing to accept.

### **Checksum (16 bits)**

It provides extra reliability. It Checksums the header, the data and conceptual pseudo header. The Checksum algorithm simply adds up all the 16bit words in one's complement and then takes one's complement of the sum. As a consequence, when the receiver performs calculations on the entire segment including the checksum field, the result should be 0 [Ref. 1].

### **Urgent data pointer (16 bits)**

Points to the octet following the urgent data; this allows the receiver to know how much urgent data is coming.

### **Options (Variable)**

At present, only one option is defined, which specifies the maximum segment size that will be accepted.

Several of the fields in the TCP header warrant further elaboration. The source port and destination port specify the sending and receiving users of TCP. As with IP, there are a number of common users of TCP that have been assigned numbers; these numbers should be reserved for that purpose in any implementation. Other port numbers must be arranged by agreement between communicating parties.

## **3.5 TCP Connection Establishment**

Before data transmission, a connection must be established. Connection establishment must take into account the unreliability of a network service, which leads to a loss of ACK, data as well as SYN. Therefore, the retransmission of these packets have to be done. Recall that a connection establishment calls for the exchange of SYNs.

Figure 4.7 illustrates typical three-way [Ref. 3] handshake operations.

- 1 Transport entity A (at the sender side) initiates the connection to transport to entity B by setting SYN bit.
- 2 Transport entity B (at the receiver side) acknowledges the request and also initiates a connection request.
- 3 "A" acknowledges to connection request of B and B sends a retransmission and B retransmits.

Now, let us test how this mechanism handles delayed SYN and ACK packets. It is shown that old SYN X arrives at B after the close of the relevant connection as shown in Figure 4.7(b). B assumes that this is a fresh request and responds with SYN j, ACK i. When A receives this message, it realises that it has not requested a connection and therefore, sends an RST, ACKj. Note that the ACKj portion of the RST message is essential so that an old duplicate RST does not abort a legitimate connection establishment. The final example Figure 4.7(c) shows a case in which an old SYN, ACK arrives in the middle of a new connection establishment. Because of the use of sequence numbers in the acknowledgements, this event causes no harm.

Sender A indicates a connection

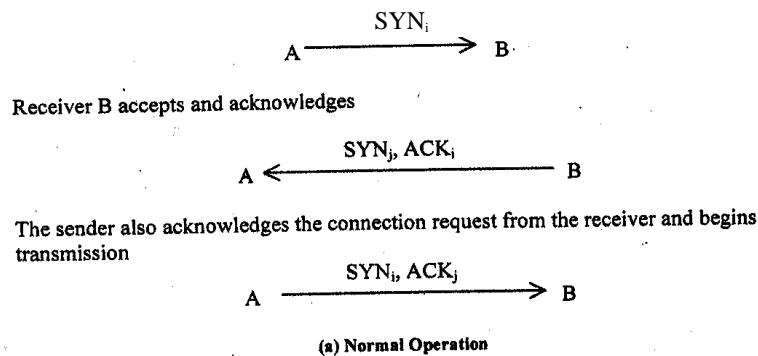

Obsolete SYN arrives from the previous connection at B

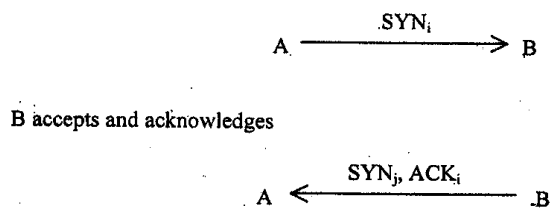

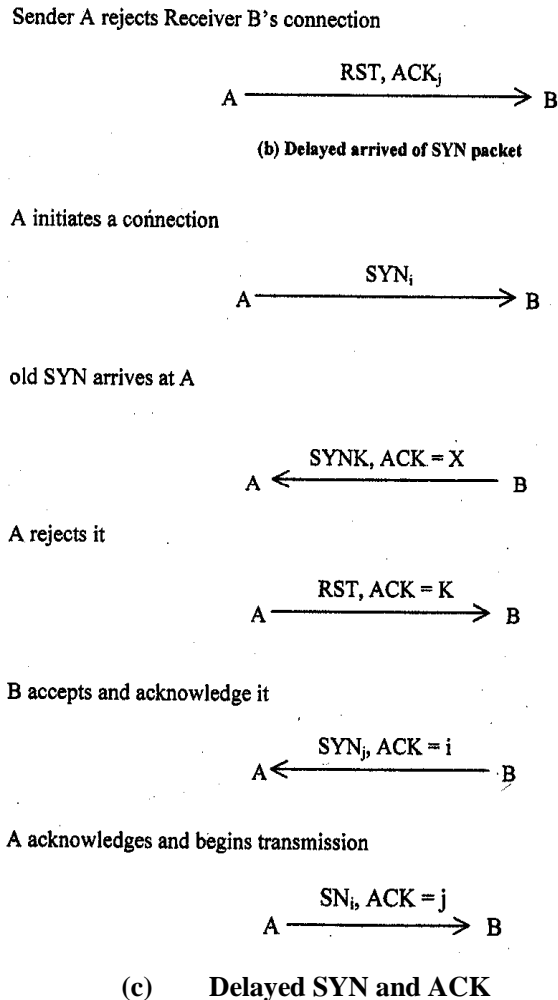

Figure 4.7: Three-way handshake mechanism

The three-way handshake procedure ensures that both transport entities agree on their initial sequence number, which must be different. Why do we need different sequence numbers? To answer this, let us assume a case, in which, the transport entities have picked up the same initial sequence number. After a connection is established, a delayed segment from the previous connection arrives at B, which will be accepted because the initial sequence number turns out to be legal. If a segment from the current connection arrives after some time, it will be rejected by host B, thinking that it is a duplicate. Thus, host B cannot distinguish a delayed segment from the new segment.

### 3.6 TCP Connection Termination

TCP adopts a similar approach to that used for connection establishment. TCP provides for a graceful close that involves the independent termination of each direction of the connection. A termination is initiated when an application tells TCP that it has no more data to send. Each side must explicitly acknowledge the FIN parcel of the other, to be acknowledged. The following steps are required for a graceful close.

- 1 The sender must send  $\text{FIN}_j$  and receive an  $\text{ACK}_j$

- 2 It must receive a  $FIN_j$  and send an  $ACK_j$
- 3 It must wait for an interval of time, to twice the maximum expected segment lifetime.

### Acknowledgement Policy

When a data segment arrives that is in sequence, the receiving TCP entity has two options concerning the timing of acknowledgment:

Immediate: When data are accepted, immediately transmit an empty (no data) segment containing the appropriate acknowledgment number.

Cumulative: When data are accepted, record the need for acknowledgment, but wait for an outbound segment with data on which to piggyback the acknowledgment. To avoid a Jong delay, set a window timer. If the timer expires before an acknowledgement is sent, transmit an empty segment containing the appropriate acknowledgement number.

### 3.7 TCP Flow Control

Flow Control is the process of regulating the traffic between two end points and is used to prevent the sender from flooding the receiver with too much data. TCP provides a flow control service to its application to eliminate the possibility of the sender overflowing. At the receiver's buffer TCP uses sliding window **with credit scheme** to handle flow control. The scheme provides the receiver with a greater degree of control over data flow. In a **credit scheme** a segment may be acknowledged without the guarantee of a new credit and vice-versa. Whereas in a fixed sliding window control (used at the data link layer), the two are interlinked (tied).

Now, let us understand this scheme with the help of a diagram.

Assume that the sender wants to send application data to the receiver. The receiver has 4 K byte buffer which is empty as shown below:

- 1 Initially buffer size = 0 4 Kbyte  

Empty
- 2 Sender transmits 2 K byte segment (data) with sequence number 0 as shown below:

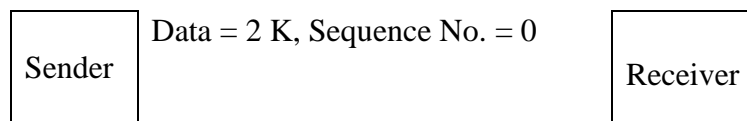

- 3 The packet is examined at the receiver. After that it will be acknowledged by it. It will also specify the credit value (windows size) of the receiver. Until the application process running at the receiver side removes some data from

buffer, its buffer size remains fixed at 2048. Therefore, credit value (window size) is 2048 byte.

Receivers  
Buffer = 

[2 K data	Empty
-----------	-------

ACK = 2048. Sequence No. = 2048 Credit = 2048

Sender Receiver

- 4 Now the sender transmits another 2048 bytes, which is acknowledged, but the advertised window (credit) is 0.

Receivers  
Buffer = 

Full
------

Data = 2048. Sequence No. = 2048

Sender Receiver

- 5 The sender must stop sending data until the application process on the receiving host has removed some data from the buffer, at which time TCP can advertise, a large window (credit value).

Receivers  
Buffer = 

Application has read 2 K byte data	2 K
--	-----

ACK = 4096. Credit = 2048

Sender Receiver

When the credit size is zero, normally there is no transmission from the sender side except in two situations:

- 1 Urgent data requires to be sent
- 2 Sender wants to know the credit size and the next byte expected by the receiver.

Both senders and receivers can delay transmission from their side to resources. If a sender knows that the buffer capacity of a receiver window is 8 K and currently it has received just 2 K, then it may buffer it at the sender side till it gets more data from the application process. Similarly, the receiver has to send some data to the sender it can delay the acknowledgement till its data is ready for that the acknowledgement can be **piggybacked**. Therefore, the basic reason of delaying the acknowledgement is to reduce the bandwidth.

Let us consider an example of a log-in session, for example, **Telnet** Session in which the user types one character at a time and the server (log-in server) reacts to every keystroke. You will notice that one character requires four exchanges of IP packets between the log-in session client and a Telnet server which is illustrated below:

Assume that TCP and IP header are 20 bytes each).

**1<sup>st</sup> exchange** (at the sender side)

- Whenever application data comes to TCP sender, it creates 20 bytes of a segment, which it gives to IP to **create an IP** datagram.

Total no. of bytes sent = 20 bytes (TCP) + 20 bytes (IP) + 1 byte for a character (a key stroke) = 41 byte.

**2<sup>nd</sup> exchange** (at the receiver side)

- The receiver (Telnet a log-in server) immediately sends an acknowledgement to the sender.

Total no. of bytes sent by the server = 20 bytes (TCP) + 20 byte (IP) = 40 bytes No extra byte is required for an acknowledgement.

**3<sup>rd</sup> exchange** (From the log-in server)

- Window update-related message which moves to window one byte right.

Total no of byte sent - 20bytes (TCP) + 20byte (IP) = 40 bytes.

**4<sup>th</sup> exchange** (From the log-in server)

- Echo Character back to the client

Total no. bytes - 20 bytes (TCP) + 20 byte (IP) + 1 byte (0 char) = 41 bytes.

Therefore, the total number of bytes exchanged = 41 + 40 + 40 + 41 = 162 bytes.

So what is the solution to reduce the wastage of bandwidth? The solution has been proposed by **Nagle** and is known as **Nagle's algorithm**.

The algorithm works as follows: When data comes the sender one byte at a time, just send the first byte and buffer all the rest until the outstanding byte is acknowledged. In the meantime, if the application generates some more characters before the acknowledgement arrives, TCP will not transmit the character but buffer them instead. After the acknowledgement arrives TCP transmits all the characters that have been waiting in the buffer in a single segment.

**Nagle's algorithm** is widely used for the TCP implementation). But in certain cases, the algorithm might not be applicable. For example, in highly interactive applications where every keystroke or a cursor movement is required to be sent immediately.



Another problem that wastes network bandwidth is when the sender has a large volume of data to transmit and the receiver can only process its receiver buffer a few bytes at a time. Sooner or later the receiver buffer becomes full. When the receiving application reads a few bytes from the receive buffer, the receiving TCP sends a small advertisement window to the sender, which quickly transmits a small segment and fills the receiver buffer again. This process goes on and on with many small segments being transmitted by the sender for a single application message. This problem is called the silly window syndrome. **It can be avoided if the receiver does not advertise the window until the window size is at least as large as half of the receiver buffer size or the maximum segment size.** The sender side can cooperate by refraining from transmitting small segments.

To summarize, the silly window syndrome can be explained stepwise as:

- Step I:       Initially the receiver buffer is full
- Step II:       Application process reads one byte at the receiver side.
  
- Step III:       The TCP running at the receiver sends a window update to the sender.
  
- Step IV:       The TCP sender sends another byte.
  
- Step V:       The receiver buffer is filled up again.

Steps III, IV and V continue forever. **Clark's** solution is to prevent the receiver from sending a window update for I byte. In the solution, the receiver window is forced to wait until it has a sufficient amount of space available and then only advertise. Specifically, the receiver should not send a window update until it can handle the maximum segment size it advertised when the connection was established, or its buffer half empty, whichever is smaller.

Nagle's algorithm and Clark's solution to the silly window syndrome are complementary. Both solutions are valid and can work together. The goal is for the sender not to send small segments and the receiver not to ask for them. Nagle was trying to solve the problem caused by the sending application delivering data to TCP a byte at a time. Clark was trying to solve the problem of the receiving application.

### 3.8 TCP Congestion Control

As discussed in the previous section, TCP provides many services to the application process. Congestion Control is one such service. TCP uses end-to-end Congestion Control rather than the network supported Congestion Control, since the IP Protocol does not provide Congestion released support to the end system. The basic idea of TCP congestion control is to have each sender transmit just the right amount of data to keep the network resources utilised but not overloaded. You are also aware that TCP flow control mechanism uses a sliding-window protocol for end-to-end flow control. This protocol is implemented by making the receiver advertise in its acknowledgement the number of bytes it is willing to receive in the future, called the advertised window to avoid the receiver's buffer from overflow. By looking at the

advertised window, the sender will resist transmitting data that exceeds the amount that is specified in the advertised window. However, the *advertised window* does not prevent the buffers in the intermediate routers from overflowing due to which routers get overloaded. Because IP does not provide any mechanism to control congestion, it is up to the higher layer to detect congestion and take proper action. It turns out that TCP window mechanism can also be used to control congestion in the network.

The protocols designers have to see that the network should be utilised very efficiently (i.e., no congestion and no underutilisation). If the senders are too aggressive and send too many packets, the network will experience congestion. On the other hand, if TCP senders are too conservative, the network will be underutilised. The maximum number of bytes that a TCP sender can transmit without congesting the network is specified by another window called the *congestion window*. To avoid network congestion and receiver buffer overflow, the maximum amount of data that the TCP sender can transmit at any time is the minimum of the advertised window (receiver window) and the congestion window. Thus, the effective window is the minimum of what the sender thinks is OK and what the receiver thinks is OK. If the receiver advertises for 8K window but the sender sends 4K size of data if it thinks that 8 K will congest the network, then the effective windows size is 4K.

The approach used in TCP is to have each sender limit the rate of data traffic into the network as a function of perceived network congestion. If a TCP sender perceives that there is small congestion along the path, then it increases its send rate otherwise it reduces it.

The TCP congestion control algorithm dynamically adjusts the congestion window according to the network state. The algorithm is called slow start. The operation of the TCP congestion control algorithm may be divided into three phases: **slow start**, **congestion avoidance** and **congestion occurrence**. The first phase is run when the algorithm starts or restarts, assuming that the network is empty. The technique, **slow start**, is accomplished by first setting the congestion window to one maximum-size segment. Each time the sender receives an acknowledgement from the receiver, the sender increases the congestion window by one segment. After sending the first segment, if the sender receives an acknowledgement before a time-out, the sender increases the congestion window to two segments. If these two segments are acknowledged, the congestion window increases to four segments, and so on. As shown in the [Figure 4.8](#), the congestion window size grows exponentially during this phase. The reason for the exponential increase is that slow start needs to fill an empty pipe as quickly as possible. The name “slow start” is perhaps a misnomer, since the algorithm ramps up very quickly.

Slow start does not increase the congestion window exponentially forever, since the network will be filled up eventually. Specifically, slow start stops when the congestion window reaches a value specified as the **congestion threshold**, which is initially set to 65,535 bytes. At this point a congestion avoidance (2nd phase) phase takes over. This phase assumes that the network is running close to full utilisation. It is wise for the algorithm to reduce the rate of increase so that it will not overshoot excessively. Specifically, the algorithm increases the congestion window **linearly** rather than exponentially when it tries to avoid congestion. This is realised by increasing the congestion window by one segment for each round-trip time.

Obviously, the congestion window cannot be increased indefinitely. The congestion window stops increasing when TCP detects that the network is congested. The algorithm now enters the third phase.

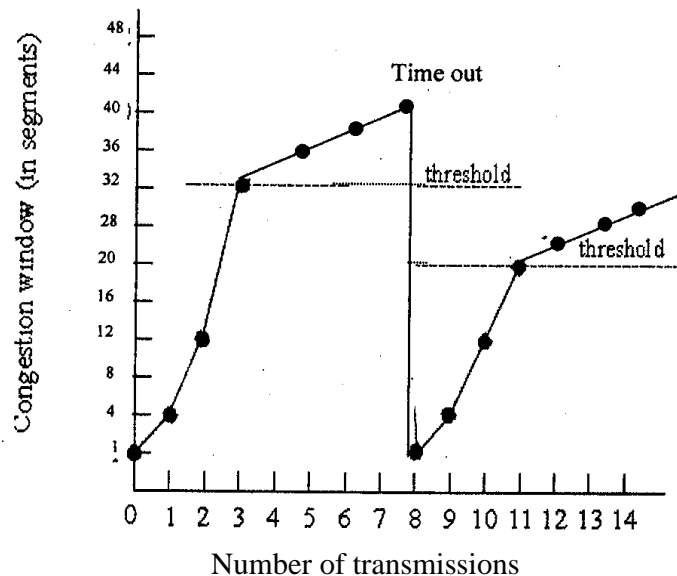

Figure 4.8: Dynamics of TCP congestion window

At this point the congestion threshold is first set to one-half of the current window size (the minimum of the congestion window and the advertised window, but at least two segments). Next the congestion window is set to one maximum-sized segment. Then the algorithm restarts, using the slow start technique.

How does TCP detect network congestion? There are two approaches:

- 1 Acknowledgement does not arrive before the timeout because of a segment loss.
- 2 Duplicate acknowledgement is required.

The basic assumption the algorithm is making is that, a segment loss is due to congestion rather than errors. This assumption is quite valid in a wired network where the percentage of segment losses due to transmission errors is generally low (less than 1 per cent). Duplicate ACK can be due to either segment reordering or segment loss. In this case the TCP decreases the congestion threshold to one-half of the current window size, as before. However, the congestion window is not reset to one. If the congestion window is less than the new congestion threshold, then the congestion window is increased as in slow start. Otherwise, the congestion window is increased as in congestion avoidance. However, the assumption may not be valid in a wireless network where transmission errors can be relatively high.

The Figure 4.8 illustrates the dynamics of the congestion window as time progresses. Thus, assumes that maximum segment size is 1024, threshold to 32K and congestion window to 1 K for the first transmission. The congestion window then grows exponentially (slow start phase) until it hits the threshold (32 K). After that it grows

linearly (congestion avoidance phase I). Now, when congestion occurs, the threshold is set to half the current window (20 K) and slow start initiated all over again. In case there is no congestion, the congestion window will continue to grow.

In short, TCP's congestion control algorithm operates as follows:

- 1 When the Congestion Window is below the threshold, the sender uses for slow start phase and congestion window grows exponentially.
- 2 When the congestion window is above the threshold the sender is in the congestion avoidance phase and congestion window grows linearly.

You may wish to refer the references [1], [2] and [4] for further clarification on the subject.

### **3.9 Remote Procedure Call**

In this section we will look at two other files access mechanisms such as Network File System and Remote Procedure Call used for accessing files from a server at the client machine. These two mechanisms allow programs to call procedures located on remote machines.

#### **Network File System (NFS)**

The network file system (NFS) is a file access protocol. FTP and TFTP transfer entire files from a server to the client host. A file access service, on the other hand, makes file systems on a remote machine visible, though they were on your own machine but without actually transferring the files. NFS provides a number of features:

- 1 NFS allows you to edit a file on another machine exactly as you would if it were on your own machine.
- 2 It even allows you to transfer files from the server to a third host not directly connected to either of you.

#### **Remote Procedure Call (RPC)**

NFS works by invoking the services of a second protocol called remote procedure call (RPC). **Figure 4.9** shows a local procedure call (in this case, a C program calls the open function to access a file stored on a disk).

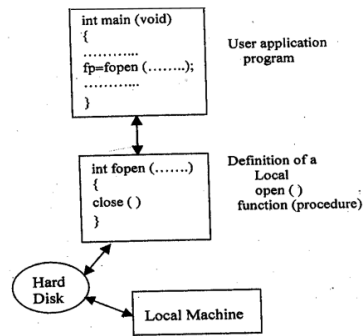

Figure 4.9: Concept of local procedure call

RPC transfers the procedure call to another machine. Using RPC, local procedure calls are mapped onto appropriate RPC function calls. Figure 14.10 illustrates the process: a program issues a call to the NFS client process. The NFS client formats the call for the RPC client and passes it along. The RPC client transforms the data into a different format and provides the interface with the actual TCP/IP transport mechanisms. At the remote host, the RPC server retrieves the call, reformats, and passes it to the NFS server. The NFS server relays the call to the remote disk, which responds as if to a local call and opens the file to the NFS server. The same process is followed in reverse order to make the calling application believe that the file is open on its own host.

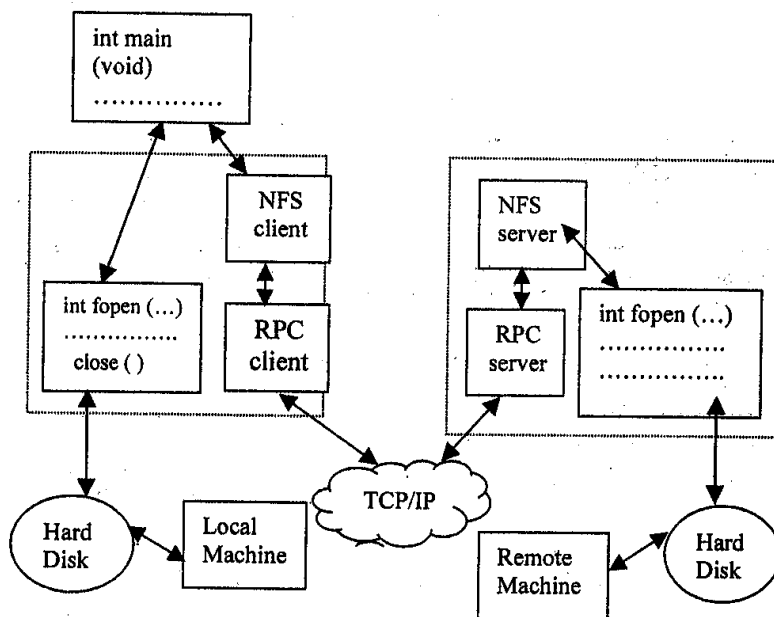

Figure 4.10: Concept of remote procedure call

There are three independent components in NFS protocol:

- 1 NFS itself
- 2 General purpose RPC
- 3 Data representing format (DRF).

In order to make the NFS computer independent what can be done is to use RPC and DRF in other software, (including application), programme by dividing a program into a client side and a server side that use RPC as the chief transport mechanism. On the client side, the transfer procedures may be designated as remote, forcing the compiler to incorporate RPC code into those procedures, On the server side, the desired procedures are implemented by using other RPC facilities to declare them as a part of a server. When the executing client program calls one of the remote procedures, RPC automatically collects values for arguments, from a message, sends the message to the remote server, awaits a response, and stores returned values in the designated arguments. In essence, communication with the remote server occurs automatically as a side-effect of a remote call. The RPC mechanism hides all the details of protocols, making it possible for programmers who know little about the underlying communication protocols but who can write distributed application programs.



#### 4.0 CONCLUSION

This unit has taken you through the various services provided by the Transport layer as well as how to establish and release TCP connections. You have also learnt how the TCP Flow Control mechanism and how it is different from data link layer as well as congestion mechanism in TCP.



#### 5.0 SUMMARY

In this unit, we discussed the two transport layer protocols (TCP & UDP) in detail. The transport port can be light weight (very simple) which provide very little facility. In such cases, the application directly talks to the IP. UDP is an example of a transport protocol, which provides minimum facility, with no control, no connection establishment, no acknowledgement and no congestion handling feature. Therefore, if the application is to be designed around the UDP, then such features have to be supported in the application itself. On the other hand, there is another protocol- TCP which provides several feature such as reliability, flow control, connection establishment to the various application services. Nevertheless, the services that the transport layer can provide often constrain the network layer protocol.

We had a close look at the TCP connection establishment, TCP flow control, TCP congestion handling mechanism and finally UDP and TCP header formats. With respect to congestion control, we learned that congestion control is essential for the well-being of the network. Without congestion control the network can be blocked.



#### 6.0 TUTOR MARKED ASSIGNMENT 14

1. Is it true that if IP is the network layer protocol, so TCP must be the transport layer 1?
2. There are two protocols at the transport layer, which of the two is better?
3. What is the difference between FTP and NFS?
4. What is a flow control problem? What is the basic mechanism at the transport layer to handle flow control problem?



## 7.0 REFERENCES/FURTHER READINGS

A.S Tanebaum, (2011). *Computer Networks*, 4th Edition, PHI, New Deihi.

J. F. Kurose & K. W. (2003). *Computer Networking*, A top down approach featuring the Internet, Ross, Pearson Edition, New Delhi.

William Stallings, (2003). *Data and Computer Communication*, 6th Edition, Pearson Education, New Delhi.

Leon Garcia, and Widjaja, (2000). *Communications Networks*, Tata McGraw Hill.

## 8.0 TUTOR MARKED ASSIGNMENT 14

### Question 1

Is it true that if IP is the network layer protocol, so TCP must be the transport layer?

### Solution

True

### Question 2

There are two protocols at the transport layer, which of the two is better?

### Solution

It depends, however, the two protocols in the Transport Layer are Transmission Control Protocol (TCP) and User Datagram Protocol (UDP). TCP gives room for dependable data conveyance service with end-to-end error detection and correction.

### Question 4

What is the difference between FTP and NFS?

### Solution

File Transfer Protocol (FTP) is employed for sending files from one place to another place, normally using Internet. With FTP you can transfer large files. Network File system (NFS) permits a user to acquire a file usually in a server.

### Question 5

What is a flow control problem? What is the basic mechanism at the transport layer to handle flow control problem?

## Solution

Flow control is the method of data communication between two nodes in such a way that the sender does not overwhelm the receiver i.e. the rate of sending the data is not faster than the receiver can receive.

The basic mechanism at the transport layer to handle flow control problem is the TCP/IP. TCP also disallows data loss due to a fast sender and slow receiver by imposing some **flow control** strategies



**CONTENTS**

- 1.0 Introduction
- 2.0 Objectives
- 3.0 Main Content
  - 3.1 Cryptography
  - 3.2 Public Key Cryptography
  - 3.3 Public Key Cryptography
    - 3.3.1 RSA Public Key Algorithm
    - 3.3.2 Diffie-Hellman
    - 3.3.3 Elliptic Curve Public Key Cryptosystems
    - 3.3.4 DSA
  - 3.4 Mathematical Background
    - 3.4.1 Exclusive OR
    - 3.4.2 The Modulo Function
- 4.0 Conclusion
- 5.0 Summary
- 6.0 Tutor-Marked Assignment
- 7.0 References/Further Readings



**1.0 INTRODUCTION**

Cryptography plays an important role in network security. The purpose of cryptography is to protect transmitted information from being read and understood by anyone except the intended recipient. In the ideal sense, unauthorised individuals can never read an enciphered message.

Secret writing can be traced back to 3,000 B.C. when it was used by the Egyptians. They used hieroglyphics to conceal writing from unintended recipients. Hieroglyphics is derived from the Greek word hieroglyphica, which means “sacred carvings”. Hieroglyphics evolved into hieratic, which was easier to use script. Around 400 B.C., military cryptography was employed by the Spartans in the form of strip of papyrus or parchment wrapped around a wooden rod. This system is called a Scytale. The message to be encoded was written lengthwise down the rod on the wrapped material. Then, the material was unwrapped and carried to the recipient. In unwrapped form, the writing appeared to random characters, and to read again the material was rewound on a rod of the same diameter and length.

During 50 B.C., Julius Caesar, the emperor of Rome, used a substitution cipher to transmit messages to Marcus Tullius Cicero. In this, letters of the alphabets are substituted for other letters of the same alphabet. Since, only one alphabet was used, this is also called monoalphabetic substitution. This particular cipher involved shifting the alphabet by three letters and substituting those letters. This is sometimes known as C3 (for Caesar shifting three places).

In this unit, we provide details of cryptography and its needs. In section 3.2 we define cryptography, Section 3.3 presents a brief review of symmetric cryptography. In

section 3.4 we discuss the Asymmetric Cryptography. We summarise the unit in section 3.6 followed by the Solutions/Answers.



## 2.0 OBJECTIVES

After going through this unit, you should be able to:

learn about the principles and practice of cryptography various symmetric and public key algorithms.



## 3.0 MAIN CONTENT

### 3.1 Cryptography

Cryptography is the science of writing in secret code and is an ancient art; the first documented use of cryptography in writing dates back to circa 1900 B.C. when an Egyptian scribe used non-standard hieroglyphics in an inscription. Some experts argue that cryptography appeared simultaneously sometime after writing was invented, with applications ranging from diplomatic missives to war-time battle plans. The new form of cryptography emerges with the widespread development of computer and communications technologies. Cryptography is a key technology when communicating over any un-trusted medium, particularly the Internet. Rivest defines cryptography as simply “Communication in the presence of adversaries”. Modern cryptographic techniques have many uses, such as access control, digital signatures, e-mail security, password authentication, data integrity check, and digital evidence collection and copyright protection.

Cryptographic systems are generically classified among three independent dimensions:

#### Types of Operation

All encryption algorithms are based on two general principles: substitution and transposition. The fundamental requirements are that no information is lost and all operations are reversible.

#### Key Used

If both sender and the receiver use the same key, then it is referred to as symmetric, single-key, secret-key, or conventional encryption. And if the encryption and decryption key are different, the system is asymmetric key, two-key, or public key encryption.

Within the context of any application-to-application communication, there are some specific security requirements: (1) Authentication, (2) Privacy/ confidentiality, (3) Integrity, and (4) Non-repudiation. There are, in general, three types of cryptographic schemes typically used to accomplish these goals: (1) secret key (or symmetric) cryptography, (2) public key (or asymmetric) cryptography, and (3) hash functions, each of which is described in the subsequent subsections.

## 3.2 Symmetric Key Cryptography

About twenty years ago, cryptography was the art of making and breaking codes. The codes were used to transfer messages over an unsecured channel. The channel should be protected from intruders who read, insert, delete or modify, messages, as depicted in [Figure 4.4](#). I. The transmission of a message is done using an encryption function E that converts the message or plaintext using the key into a cipher **text**. The receiver does the reverse of this operation, using the decryption function D and a decryption key to recover the plaintext from the cipher text. The key is distributed in advance over a secure channel, for example by courier.

Normally, the encryption and decryption function, but not the key, are considered known to the adversary, so the protection of the information depends on the key only. If the enemy knows the key, the whole system is useless until a new key is distributed. In secret Key Cryptography, a single key is used for both encryption and decryption, as shown in [Figure 4.11](#). The main difficulty with this approach is the distribution of the key.

Secret key cryptography schemes are generally categorised as being either stream ciphers or block ciphers. Stream ciphers operate on a single byte (or computer word) at a time, and implement some form of feedback mechanism so that the key is constantly changing. Block cipher scheme encrypts one block of data at a time using the same key on each block.

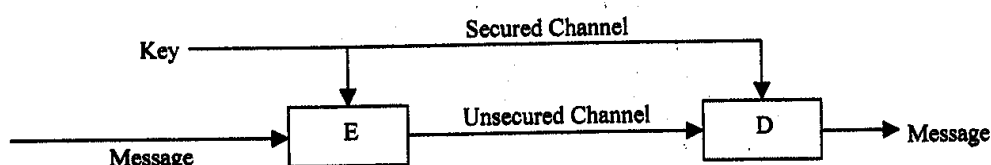

**Figure 4.11: Secret Key Cryptography**

The most common secret key cryptography scheme is Data Encryption Standard (DES), designed by IBM in I 970s and adopted by the National Bureau of Standard (NBS) of USA [now the National Institute for Standards and Technology (NIST)] in 1977 for commercial and unclassified government applications. DES is a block-cipher employing a 56-bit key operating on 64-bit blocks of data. DES has a complex set of rules and transformations designed basically for fast hardware implementation and slow software implementation. The latter point is significant in today's context, as the speed of CPU is several orders of magnitude faster than twenty years ago. IBM also proposed a 112-bit key for DES in the 1990s, which was never implemented seriously.

In 1997, NIST initiated the task of developing a new secure cryptosystem for U.S government applications. This effort has resulted in AES (Advanced Encryption Standard). AES became the official successor to DES in December 2001. AES is based on Rjndael Algorithm and employs a 128-, 192-, or 256-bit key.

The following terminology is often used when symmetric ciphers are examined:

## Block Ciphers

A block cipher transforms  $n$ -bit plaintext blocks to  $n$ -bit ciphertext blocks on the application of a cipher key  $k$ . The key is generated at random using various mathematical functions as shown in Figure 4.12.

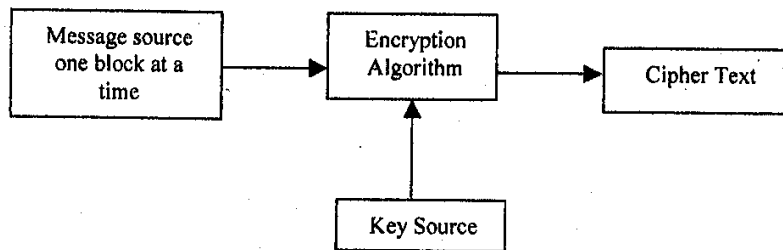

Figure 4.12: Block cipher

A stream cipher consists of a state machine that outputs at each state transition one bit of information. This stream of output bits is called the running key. Just XOR ring the running key to the plaintext message can implement the encryption. The state machine is a pseudo-random number generator. For example, we can build one from a block cipher by encrypting repeatedly its own output. Typically, more elaborate constructions (for high speed) are used for stream ciphers. Some of the more well-known stream ciphers are **Reverse Cipher 4 (RC4)** and **Software Optimization Encryption (SEAL)**. Several stream ciphers are based on linear-feedback shift registers (LFSR) (Figure 4.13), such as A5/1 used in the **Global System of Mobile Communication (GSM)**. These have the benefit of being very fast (several times faster than usual block ciphers).

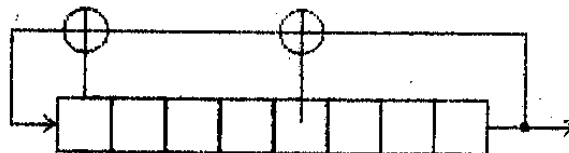

Figure 4.13: Stream cipher linear feedback shift register (LFSR)

## SSSC (Self-Synchronising Stream Ciphers)

The class of *self-synchronising stream* ciphers has property that it corrects the output stream after the bit flips or even drops bits after a short time. SSSCs ‘can be constructed using block ciphers in a CFB- related way. Assume, that we have already encrypted” bits of the message and know that much of the ciphertext (where  $n$  denotes the block length of the cipher). Then we produce a new running key bit by encrypting ‘the  $n$  ciphertext bits. Take one bit of the output of the cipher to be the new running key bit. Now moving one bit further we can iterate this procedure for the whole length of the message.

One-bit error in a ciphertext cannot affect the decrypted plaintext after  $n$  bits. This makes the cipher self-synchronising.

The block cipher used should have sufficiently large block size to avoid substitution attacks.

### Substitution and Transposition

A substitution (Figure 4.4) means replacing symbols or group of symbols by other symbols or groups of symbols. Transposition (Figure 4.15), on the other hand, means permuting the symbols in a block. Neither of these operations alone provides sufficient security, but strong ciphers can be built by combining them. A Substitution-Permutation Network (SPN) means a cipher composed of a number of stages, each involving substitutions and permutations. The prominent examples of SPNs are DES and CAST-128.

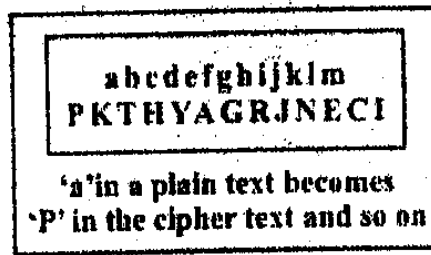

Figure 4.14: Substitution

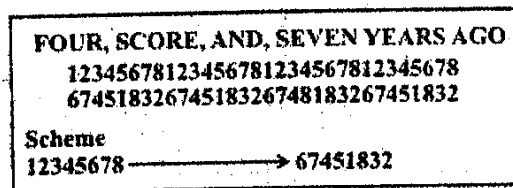

Figure 4.15: Transition

### S-Boxes

Lookup tables that map  $n$  bits to  $m$  bits, where  $n$  and  $m$  are often equal. There are several ways of constructing and measuring good S-boxes for ciphers.

- 1 S-boxes, which are resistant against well-known attacks, can be created using rigorous mathematical approach by applying bent functions (or related).
- 2 Other designers apply heuristic approaches that result in S-boxes that are more difficult to handle in mathematical proofs, but can have additional benefits.

The S-box may even be the only non-linear part of the cipher (e.g., DES) and thus, may be considered as the single most important part of the cipher. In fact, DES's S-boxes are so good that it is used in many other ciphers design (for example, Serpent).

### Feistel Networks

The original idea was used in the block cipher, Lucifer, invented by **Horst Feistel**. Several variations have been devised from the original version. A **Feistel** network (Figure 4.16) is a general way of constructing block ciphers from simple functions.

The standard **Feistel** network takes a function from  $n$  bits to  $n$  bits and produces an invertible function from  $2n$  bits to  $2n$  bits. The structure of **Feistel** network is based on round function. The essential property of Feistel networks that makes them so useful in cipher design is that the round function need not be invertible, but always is the resulting function. If the round function depends on, say,  $k$  bits of a key, then the **Feistel cipher** requires  $rk$  bits of the key where  $r$  is the number of rounds used. The security of the **Feistel** structure is not obvious. It is compulsory that a **Feistel** cipher has enough number of rounds, but just adding more rounds does not always guarantee security.

The process of taking the user key and expanding it into  $rk$  bits for the **Feistel** rounds is called **key scheduling**. This is often a non-linear operation and hence does not directly provide any information about the actual user key. There are many ciphers that have this basic structure; Lucifer, DES, and Twofish etc.

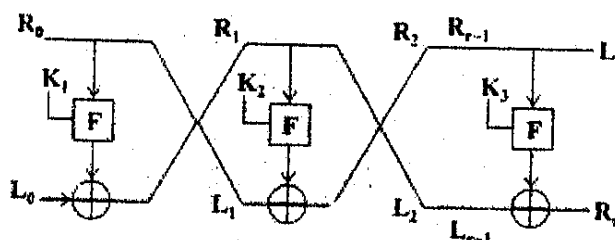

Figure 4.16: Feistel' Cipher

### Expansion, Permutation

They are linear operations, and thus, not sufficient to guarantee security. They are common tools in mixing bits in a round function and when used with good non-linear B-boxes (as in DES) they are vital for the security because they propagate the non-linearity uniformly over all bits.

### Bitslice Operations (Bitwise Logic Operations XOR AND, OR, NOT and Bit Permutations)

The idea of bitslice implementations of block ciphers is due to Eli Biham. It is common in vector machines to achieve parallel operation. However, Biham applied it on serial machines by using large registers as available in modern computers. The term "bitslice" has been the contribution of Matthew Kwan.

All block ciphers can be designed in bitslice manner, but this could affect the speed of operations such as addition and multiplication they may become very slow. On the other hand, permutations are almost free as they only require a *renaming* of the registers and this can be done at the coding level. Thus, for example, in DES exhaustive key search using bitslice techniques, one can increment the current key in, a fraction of a time than is usually needed for key scheduling.

The AES finalist *Serpent* is designed to be implemented using bitslice operations only. This makes it particularly efficient on modern architectures with many registers.

## Modes of Operation

Block ciphers are the most commonly used cipher. Block ciphers transform a fixed-size block of data (usually 64 bits) into another fixed-size block (possibly 64 bits wide again) using a function selected by the key. If the key, input block and output block have all  $n$  bits, a block cipher basically defines a one-to-one mapping from  $n$ -bit integers to permutations of  $n$ -bit integers.

If the same block is encrypted twice with the same key, the resulting ciphertext blocks are also the same (this *mode* of encryption is called *electronic code book*, or **ECB**). This information could be useful for an attacker. For identical plaintext blocks being encrypted to different ciphertext blocks, three standard modes are generally used:

### 1 CBC (Cipher Block Chaining)

First XORing the plaintext block with the previous ciphertext block obtains a ciphertext block, and then the resulting value needs to be encrypted. In this, leading blocks influence all trailing blocks, which increases the number of plaintext bits one ciphertext bit depends on, but this may also lead to synchronisation problems if one block is lost. The Process of Cipher Block Chaining shown in *Figure 4.17*. In this Figure  $m_1$ ,  $m_2$ ,  $m_3$ ) are messages and  $C_1$ ,  $C_2$  and  $C_3$  are ciphertexts.

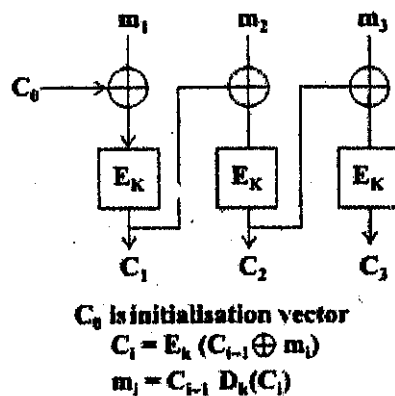

Figure 4.17: Cipher block chaining

### 2. CFB (Cipher Feedback)

In this the  $k$ th ciphertext block is obtained by encrypting the  $(k-1)$ th ciphertext block and XORing the result onto the plaintext. The CFB mode possess self-synchronising property: A CFB feedback loop can also be used as a pseudo-random number generator (**PRNG**) if one simply feeds one block of true random data with trailing blocks of zeroes into the encryption routine (although the expected period of this

PRNG would be only about  $r$  where  $n$  is the block size of the cipher). CFB is shown in *Figure 4.18*.

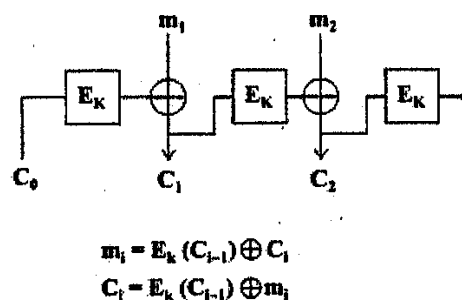
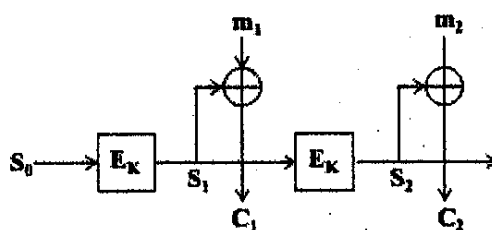

Figure 4.18: Cipher feedback model

#### 4 OFB (Output Feedback Block)

It is used as a synchronous key-stream generator, whose output is XORed with the plaintext to obtain ciphertext, block by block. The key-stream is generated by iterative encryption, starting with an initialisation vector (IV) which, along with the key, is agreed upon beforehand. OFB is shown in *Figure 4.19*.



Each data block  $S_i$  is derived from encryption provision data block  $S_i$

$$C_i = m_i \oplus S_i \quad m_i = C_i \oplus S_i \quad S_i = E_k(S_{i-1})$$

Figure 4.19: Output feedback block

#### The One-Time Pad

The one-time pad (OTP) is the only cipher that has been proven to be unconditionally 'secure, i.e., unbreakable in practice. Further, it has been proven that any unbreakable, unconditionally secure cipher must be a one-time pad.

The Vernam cipher (invented by **G. Vernam** in 1917) is a one-time pad and is very simple: take a stream of bits that contain the plaintext message, and a key, which is the secret random bit-stream of the same length as the plaintext. [To encrypt the plaintext with the key, sequentially exclusive-or each pair of key bit and plaintext bit to obtain the ciphertext bit]. If the key is truly random, the attacker or adversary has no means of deciding whether some guessed plaintext is more likely than any other when, only the ciphertext and no knowledge of the plaintext is available.



The main practical problem is that the key does not have a small constant length, but the same length as the message, and one part of a key should never be used twice (or the cipher can be broken). However, this cipher has allegedly been in widespread use since its invention, and even more since the security proof by **C. Shannon** in 1949. Although, admittedly the security of this cipher had been conjectured earlier, it was **Shannon** who actually found a formal proof for it.

## **DES**

The Data Encryption Standard (DES) is an algorithm developed in the mid-1970s and turned into a standard by the US National Institute of Standards and Technology (NIST), and was also adopted by several other governments worldwide. It was and still is widely used, especially in the financial industry.

DES is a block cipher with a 64-bit block size. It uses 56-bit keys. This makes it susceptible to exhaustive key search with modern computing powers and special-purpose hardware. DES is still strong enough to keep most random hackers, adversaries and individuals out, DES is easily breakable with special hardware by government, criminal organizations etc. DES is getting too weak, and should not be used in new applications. NIST proposed in 2004 to withdraw the DES standard.

A variant of DES, Triple-DES (also 3DES) is based on using DES three times (normally in an encrypt-decrypt-encrypt sequence with three different, unrelated keys). The Triple-DES is arguably much stronger than (single) DES, however, it is rather slow compared to some new block ciphers.

Although, at the time of DES's introduction, its design philosophy was held secret. Some information has been published about its design, and one of the original designers, **Don Coppersmith**, has said that they discovered ideas similar to differential crypt analysis while designing DES in 1974. However, it was just a matter of time that these fundamental ideas were re-discovered.

Although DES is no longer considered a practical solution, it is many a time used to describe new crypt analytical methods. Even today, there are no crypt analytical techniques that would completely break DES in a structural way; indeed, the only real weakness known is the short key size (and perhaps the small block size).

### **DES uses the:**

Data Encryption Algorithm (DEA),

A secret key block-cipher employing a 56-bit key operating on 64-bit blocks.

FIPS 81 describes four modes of DES operation: Electronic Codebook (ECB), Cipher Block Chaining (CBC), Cipher Feedback (CFB), and Output Feedback (OFB). Despite all these options, ECB is the most commonly deployed mode of operation.

DES uses a 56-bit key, which is divided into eight 7-bit blocks and an 8th odd parity bit is added to each block (i.e., a "0" or "1" is added to the block so that there are an odd number of 1 bit in each 8-bit block). By using the 8 parity bits for rudimentary

error detection, a DES key is actually 64 bits in length for computational purposes (although it only has 56 bits worth of randomness, or *entropy*).

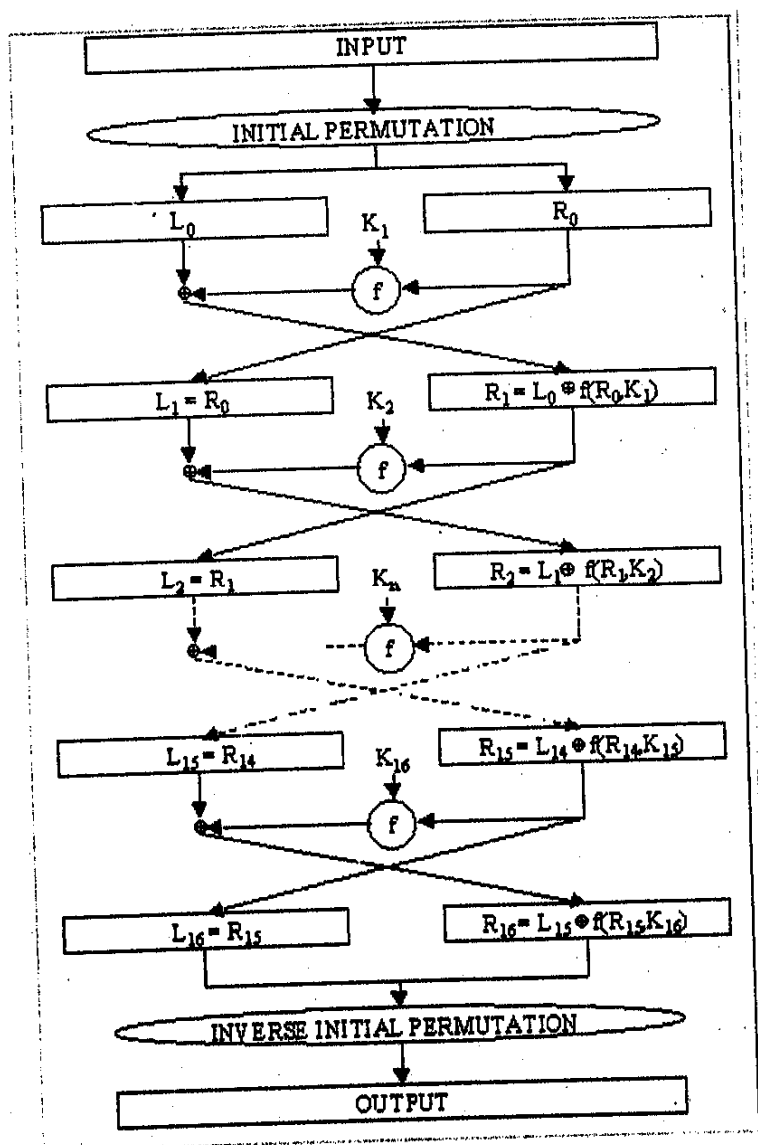

Figure 4.20: DEI; algorithm

DES process on 64-bit blocks of the plaintext, invoking 16 rounds of permutations, swaps, and substitutes, as shown in Figure 4.20. The main DES steps are:

- 1 The 64-bit block undergoes an initial permutation (IP), where each bit is moved to a new bit position; e.g., the 1st, 2nd, and 3rd bits are moved to the 58th, 50th, and 42nd position, respectively.
- 2 The permuted 64-bit input is divided into two 32-bit blocks, called *left* and *right*, respectively. The initial values of the left and right blocks are denoted as  $L_0$  and  $R_0$ .
- 3 There are then 16 rounds of operation on the L and R blocks.  
During each iteration (where n ranges from 1 to 16), the following formula is used:

$$L_n = R_{n-1}$$

$$R_n = L_{n-1} \text{ XOR } f(R_{n-1}, K_n)$$

The new L block value is taken from the prior R block value- The new R block is calculated by taking the bit-by-bit exclusive-OR (XOR) of the prior Lblock with the results of applying the DES cipher function,  $f$ , to the prior R block and  $K_n$ . ( $K_n$  is a 48-bit value derived from the 64-bit DES key). Each round uses a different 48 bits according to the standard's Key Schedule algorithm.

The cipher function,  $f$ , combines the 32-bit R block value and the 48-bit subkey in the following way:

First, the 32 bits in the R block are expanded to 48 bits by an expansion function (E); the extra 16 bits are found by repeating the bits in 16 predefined positions.

The 48-bit expanded R-block is then ORed with the 48-bit subkey.

The result is a 48-bit value that is then divided into eight 6-bit blocks.

These are fed as input into 8 selection (S) boxes, denoted  $S_1, \dots, S_8$ . Each 6-bit input yields a 4-bit output using a table lookup based on the 64 possible inputs; this results in a 32-bit output from the S-box. The 32 bits are then rearranged by a permutation function (P), producing the results from the cipher function.

The results from the final DES round – i.e.,  $L_{16}$  and  $R_{16}$  -are recombined into a 64-bit value and fed into an inverse initial permutation ( $IP^{-1}$ ). At this step, the bits are rearranged into their original positions, so that the 58th, 50th, and 42nd bits, for example, are moved back into the 1st, 2nd, and 3rd positions, respectively. The output from  $IP^{-1}$  is the 64-bit ciphertext block.

## Breaking DES

DES's 56-bit key was too short to withstand a brute-force attack from computing power of modern computers. Remember Moore's Law: computer power doubles every 18 months. Keeping this law in mind, a key that could withstand a brute-force guessing attack in 2000 could hardly be expected to withstand the same attack a quarter of a century later.

DES is even more vulnerable to a brute-force attack as it is commonly used to encrypt words, meaning that the entropy of the 64-bit block is greatly reduced. That is, if we are encrypting random bit streams, then a given byte might contain anyone of  $2^8$  (256) possible values and the entire 64-bit block has  $2^{64}$ , or about 18.5 quintillion, possible values. If we are encrypting words, however, we are most likely to find a limited set of bit patterns; perhaps 70 or so if we account for upper and lower case letters, the numbers, space, and some punctuation. That is, only about 1/4 of the bit combinations of a given byte are likely to occur. Despite this, the U.S. government insisted throughout the mid-1990s that 56-bit DES was secure and virtually unbreakable if appropriate precautions were employed. In response, RSA

Laboratories sponsored a series of cryptographic challenges to prove that DES was no longer secure and appropriate for use.

**DES Challenge I** was launched in March 1997. R. Verser completed it in 84 days in a collaborative effort to break DES using thousands of computers on the Internet. The first DES II challenge lasted 40 days during early 1998, This problem was solved by distributed.net, a worldwide distributed computing network using the spare CPU cycles of computers around the Internet. The participants in distributed.net activities load a client program that runs in the background, conceptually similar to the SETI @Home “Search for Extra-terrestrial Intelligence” project). By the end of the project, distributed.net systems were checking 28 billion keys per second.

The second **DES II challenge** lasted just less than 3 days. On July 17, 1998, the Electronic Frontier Foundation (EFF) announced the construction of a hardware that could brute-force a DES key in an average of 4.5 days. The device called Deep Crack, could check 90 billion keys per second and cost only about \$220,000 including design. As the design is scalable, this suggests that an organization could develop a DES cracker that could break 56-bit keys in an average of a day for as little as \$1,000,000.

The **DES III challenge**, launched in January 1999, was broken in less than a day by the coordinated efforts of Deep Crack and distributed.net.

The Deep Crack algorithm is to launch a brute-force attack by guessing every possible key. A 56-bit key yields  $2^{56}$ , or about 72 quadrillion, possible values. The DES cracker team initially assumed that *some* recognisable plaintext would appear in the decrypted string even though they didn't have a specific known plaintext block. They then applied all  $2^{56}$  possible key values to the 64-bit block. The system checked to find if the decrypted value of the block was “interesting”, which they defined as bytes containing one of the alphanumeric characters, space, or some punctuation. As the likelihood of a single byte being “interesting” is about  $\frac{1}{4}$ , then the likelihood of the entire 8-byte stream being “interesting” is about  $\frac{1}{4^8}$ , or  $1/65536$  ( $\frac{1}{2^{16}}$ ). This dropped the number of possible keys that might yield positive results to about  $2^{40}$ , or about a trillion.

After the assumption that an “interesting” 8-byte block would be followed by another “interesting” block. Therefore, if the first block of ciphertext decrypted to something interesting, they decrypted the next block; otherwise, they abandoned this key. Only if the second block was also “interesting” did they examine the key closer. Looking for 16 consecutive bytes that were “interesting” meant that only  $2^{24}$ , or 16 million, keys required to be examined further. This further examination was primarily to see if the text made any sense.

It is important to mention a couple of forms of crypt analysis that have been shown to be effective against DES. *Differential cryptanalysis*, invented in 1990 by **E. Biham** and **A. Shamir** (of RSA fame), is a chosen-plaintext attack. By selecting pairs of plaintexts with particular differences, the crypt analyst examines the differences in the resultant ciphertext pairs. *Linear plaintext*, invented by **M. Matsui**, uses a linear approximation to analyse the actions of a block cipher (including DES). Both these attacks one be more efficient than brute force.

## DES Variants

After DES algorithm was “officially” broken, several variants appeared. In the early 1990s, there was a proposal to increase the security of DES by effectively increasing the key length by using multiple keys with multiple passes etc. But for this scheme to work, it had to first be shown that, the DES function is not a group, as defined in mathematics. If DES was a group, then we could show that for two DES keys,  $X_1$  and  $X_2$ , applied to some plaintext ( $P$ ), we can get a single equivalent key,  $X_3$ , that would provide the same result; i.e.,

$$E_{X_2}(E_{X_1}(P)) = E_{X_3}(P)$$

where  $E_X(P)$  represents DES encryption of some plaintext  $P$  using DES key  $X$ . If DES were a group, it wouldn't matter how many keys and passes we applied to some plaintext; we could always find a single 56-bit key that would provide the same result.

As DES was proven not to be a group, we apply additional keys and passes to increase the effective key length. One choice, then, might be to use two keys and two passes, yielding an effective key length of 112 bits. This can be called Double-DES. The two keys,  $Y_1$  and  $Y_2$ , might be applied as follows:

$$\begin{aligned} C &= E_{Y_2}(E_{Y_1}(P)) \\ P &= D_{Y_1}(D_{Y_2}(C)) \end{aligned}$$

where  $E_Y(P)$  and  $D_Y(C)$  represent DES encryption and decryption, respectively, of some plaintext  $P$  and ciphertext  $C$ , respectively, using DES key  $Y$ .

But an interesting attack can be launched against this “Double-DES” scheme. The applications of the formula above can be with the following individual steps (where  $C'$  and  $P'$  are intermediate results):

$$\begin{aligned} C' &= E_{Y_1}(P) \text{ and } C = E_{Y_2}(C') \\ P' &= D_{Y_2}(C) \text{ and } P = D_{Y_1}(P') \end{aligned}$$

Unfortunately,  $C'=P'$ , which leaves it vulnerable to a simple *known plaintext* attack (or “Meet-in-the-middle”) where the attacker or adversary knows some plaintext ( $P$ ) and its matching ciphertext ( $C$ ). To obtain  $C'$ , the attacker or adversary needs to try all  $2^{56}$  possible values of  $Y_1$  applied to  $P$ ; to obtain  $P'$ , the attacker needs to try all  $2^{56}$  possible values of  $Y_2$  applied to  $C$ . Since  $C'=P'$ , the attacker knows when a match has been achieved – after only  $2^{56} + 2^{56} = 2^{57}$  key searches, only twice the work of brute-forcing DES.

**Triple-DES (3DES) is based upon the Triple Data Encryption**

Algorithm (mEA), as described in FIPS 46-3. 3DES, which is not susceptible to a meet-in-the-middle attack, employs three DES passes and one, two, or three keys called K1, K2, and K3. Generation of the ciphertext (C) from a block of plaintext (P) is accomplished by:

$C = E_{K3}(D_{K2}(E_{K1}(P)))$  where  $E_K(P)$  and  $D_K(P)$  represent DES encryption and decryption, respectively, of some plaintext P using DES key K. This is also sometimes referred to as an encrypt-decrypt-encrypt mode operation.

Decryption of the ciphertext into plaintext is accomplished by:

$$P = D_{K1}(E_{K2}(D_{K3}(C)))$$

The use of three, independent 56-bit keys provides 3DES with an effective key length of 168 bits. The specification also defines use of two keys where, in the operations above,  $K3 = K1$ ; this provides an effective key length of 112 bits. Finally, a third keying option is to use a single key, so that  $K3 = K2 = K1$  (in this case, the effective key length is 56 bits and 3DES applied to some plaintext, P, will yield the same ciphertext, C, as normal DES would with that same key). With the relatively low cost of key storage and the modest increase in processing due to the use of longer keys, the best recommended practices are that 3DES are employed with three keys.

Another variant of DES, called DESX, is the contribution of Ron Rivest. Developed in 1996, DESX is a very simple algorithm that greatly increases DES's resistance to brute-force attacks without increasing its computational complexity. In DESX, the plaintext input is XORed with 64 additional key bits prior to encryption and the output is likewise XORed with the 64 key bits. By adding just two XOR operations, DESX has an effective keylength of 120 bits against an exhaustive key-search attack. It is pertinent to note that DESX is not immune to other types of more sophisticated attacks, such as differential or linear crypt analysis, but brute-force is the primary attack vector on DES.

## AES

In response to cryptographic attacks on DES, search for a replacement to DES started in January 1997. In September 1997, a formal Call for Algorithms was initiated and in August 1998 announced that 15 candidate algorithms were being considered (Round 1). In April 1999, NIST announced that the 15 had been filtered down to five finalists (Round 2): *MARS* (multiplication, addition, rotation and substitution) from IBM; **Ronald Rivest's** *RC6*; *Rijndael* from a Belgian team; *Serpent*, developed jointly by a team from England, Israel, and Norway; and *Twofish*, developed by Bruce **Schneier**. In October 2000, NIST announced their selection: *Rijndael*.

In October 2000, NIST published the Report on the Development of the Advanced Encryption Standard (AES) that compared the five Round 2 algorithms in a number of categories. The [figure 4.21 below](#) summarises the relative scores of the five schemes (1=low,3=high):

Category	MARS	RC6	Rijndael	Serpent	Twofish
General security	3	2	2	3	3
Implementation of security	1	1	3	3	2
Software performance	2	2	3	1	1
Smart card performance	1	1	3	3	2
Hardware performance	1	2	3	3	2
Design features	2	1	2	1	3

Figure 4.21: Algorithm

NIST selected Rijndael as its performance in hardware and software across a wide range of environments in all possible modes. It has excellent key setup time and has low memory requirements; in addition its operations are easy to defend against power and timing attacks.

In February 2001, NIST published the Draft Federal Information Processing Standard (FIPS) AES Specification for public review and comment. AES contains a subset of Rijndael's capabilities (e.g., AES only supports a 128-bit block size) and uses some slightly different nomenclature and terminology, but to understand one is to understand both. The 90-day comment period ended on May 29, 2001 and the U.S. Department of Commerce officially adopted AES in December 2001, published as FIPS PUB 197.

### AES (Rijndael) Overview

Rijndael (pronounced as in "rain doll" or "rhine dahl") is a block cipher designed by Joan Daemen and Vincent Rijmen, both cryptographers in Belgium. Rijndael can operate over a variable-length block using variable-length keys; the version 2 specification submitted to NIST describes use of a 128-, 192-, or 256-bit key to encrypt data blocks that are 128, 192, or 256 bits long. The block length and/or key length can be extended in multiples of 32 bits and it is specifically designed for efficient implementation in hardware or software on a range of processors. The design of Rijndael was strongly influenced by the block cipher called *Square*, also designed by **Daemen** and **Rijmen**. Rijndael is an iterated block cipher, meaning that the initial input block and cipher key undergoes multiple rounds of transformation before producing the output. Each intermediate **block of cipher to be encrypted is** called State.



For simplicity, the block and cipher key are often given as an array of columns where each array has 4 rows and each column represents a single byte (8 bits). The number of columns in an array representing the state or cipher key, then, can be calculated as the block or key length divided by 32 (32 bits = 4 bytes). An array representing a State will have  $N_b$  columns, where  $N_b$  values of 4, 6, and 8 correspond to a 128-, 192-, and 256-bit block, respectively. Similarly, an array representing a Cipher Key will have  $N_k$  columns, where  $N_k$  values of 4, 6, and 8 correspond to a 128-, 192-, and 256-bit key, respectively. An example of a 128-bit State ( $N_b = 4$ ) and 192-bit Cipher Key ( $N_k = 6$ ) is shown below:

$s_{0,0}$	$s_{0,1}$	$s_{0,2}$	$s_{0,3}$	$k_{0,0}$	$k_{0,1}$	$k_{0,2}$	$k_{0,3}$	$k_{0,4}$	$k_{0,5}$
$s_{1,0}$	$s_{1,1}$	$s_{1,2}$	$s_{1,3}$	$k_{1,0}$	$k_{1,1}$	$k_{1,2}$	$k_{1,3}$	$k_{1,4}$	$k_{1,5}$
$s_{2,0}$	$s_{2,1}$	$s_{2,2}$	$s_{2,3}$	$k_{2,0}$	$k_{2,1}$	$k_{2,2}$	$k_{2,3}$	$k_{2,4}$	$k_{2,5}$
$s_{3,0}$	$s_{3,1}$	$s_{3,2}$	$s_{3,3}$	$k_{3,0}$	$k_{3,1}$	$k_{3,2}$	$k_{3,3}$	$k_{3,4}$	$k_{3,5}$

The number of transformation rounds ( $N_r$ ) in Rijndael is a function of the block length and key length, and is given in the [Figure 4.22](#):

Rounds $N_r$		Block Size		
		128 bits $N_b = 4$	192 bits $N_b = 6$	256 bits $N_b = 8$
Key Size	128 bits $N_k = 4$	10	12	14
	192 bits $N_k = 6$	12	12	14
	256 bits $N_k = 8$	14	14	14

**Figure 4.22: Transmission Rounds ( $N_r$ ) in Rijndael**

The AES version of Rijndael does not support all nine combinations of block and key lengths, but only the subset using a 128-bit block size. NIST calls these supported variants AES-128, AES-192, and AES-256 where the number refers to the key size. The  $N_b$ ,  $N_k$ , and  $N_r$  values supported in AES are: [in Table 4.23](#)

Variant	Parameters		
	$N_b$	$N_k$	$N_r$
<b>AES-128</b>	4	4	10
<b>AES-192</b>	4	6	12
<b>AES-256</b>	4	8	14

**Table 4.23: Supported Variables**

The AES/Rijndael cipher itself has three operational stages:

AddRound Key transformation

$N_r - 1$  Rounds comprising: SubBytes transformation; ShiftRows transformation; MixColumns transformation; AddRoundKey transformation

A final Round comprising: SubBytes transformation; ShiftRows transformation; AddRoundKey transformation.



The nomenclature used below is taken from the AES specification, although, references to the Rijndael specification are made for completeness. The arrays  $s$  and  $s'$  refer to the State before and after a transformation, respectively (NOTE: The Rijndael specification uses the array nomenclature  $a$  and  $b$  to refer to the before and after States, respectively). The subscripts  $i$  and  $j$  are used to indicate byte locations within the State (or Cipher Key) array.

## The SubBytes Transformation

The substitute bytes (called ByteSub in Rijndael) transformation operates on each of the State bytes independently and changes the byte value. An S-box, or *substitution table*, controls the transformation. The characteristics of the S-box transformation as well as a compliant S-box table are provided in the AES specification; as an example, an input State byte value of 107 (0x6b) will be replaced with a 127 (0x7f) in the output State and an input value of 8 (0x08) would be replaced with a 48 (0x30).

One simple way to think of the SubBytes transformation is that a given byte in States is given a new value in States' according to the S-box. The S-box, then, is a function on a byte in States so that:

$$S_{ij} = \text{S-box}(s_{ij})$$

The more general depiction of this transformation is shown by:

$$\begin{array}{cccc}
 s_{0,0} & s_{0,1} & s_{0,2} & s_{0,3} \\
 s_{1,0} & s_{1,1} & s_{1,2} & s_{1,3} \\
 s_{2,0} & s_{2,1} & s_{2,2} & s_{2,3} \\
 s_{3,0} & s_{3,1} & s_{3,2} & s_{3,3}
 \end{array}
 \xrightarrow{\text{S-box}}
 \begin{array}{cccc}
 s'_{0,0} & s'_{0,1} & s'_{0,2} & s'_{0,3} \\
 s'_{1,0} & s'_{1,1} & s'_{1,2} & s'_{1,3} \\
 s'_{2,0} & s'_{2,1} & s'_{2,2} & s'_{2,3} \\
 s'_{3,0} & s'_{3,1} & s'_{3,2} & s'_{3,3}
 \end{array}$$

## The ShiftRows Transformation

The shift rows transformation cyclically shifts the bytes in the bottom three rows of the State array. According to the more general Rijndael specification, rows 2, 3, and 4 are cyclically left-shifted by  $C_1$ ,  $C_2$ , and  $C_3$  bytes, **respectively**, per the **figure 4.24**:

Nb	C1	C2	C3
4	1	2	3
6	1	2	3
8	1	3	4

Figure 4.24: Shiftrows Transformation

The current version of AES, of course, only allows a block size of 128 bits ( $Nb = 4$ ) so that  $C_1=1$ ,  $C_2=2$ , and  $C_3=3$ .

The diagram below shows the effect of the Shift Rows transformation on States:

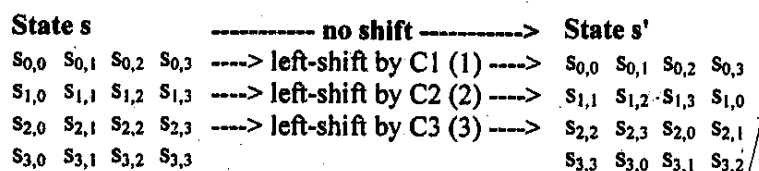

### The MixColumns Transformation

The mix columns (called MixColumn in Rijndael) transformation uses a mathematical function to transform the values of a given column within a State, acting on the four values at one time as if they represented a four-term polynomial.

$$s'_{i,c} = \text{MixColumns}(s_{i,c}) \text{ for } 0 \leq i \leq 3 \text{ for some column, } c.$$

The column position does not change, however, the values within the column change.

### Round Key Generation and the AddRoundKey Transformation

The Cipher Key is used to derive a different key to be applied to the block during each round of the encryption operation. These keys are known as the Round Keys and each will be the same length as the block, i.e.,  $N_b$  32-bit words.

The AES defines a key schedule by which the original Cipher Key (of length  $N_k$  32-bit words) is used to form an *Expanded Key*. The *Expanded Key* size is equal to the block size multiplied by the number of encryption rounds plus 1, which will provide  $N_r+1$  different keys. (Note that there are  $N_r$  encipherment rounds but  $N_r+1$ .

AddRoundKey transformations). For example, AES uses a 128-bit block and either 10, 12, or 14 iterative rounds depending upon key length. With a 128-bit key, we would need 1408 bits of key material ( $128 \times 11 = 1408$ ), or an *Expanded Key* size of 44 32-bit words ( $44 \times 32 = 1408$ ). Similarly, a 192-bit key would require 1664 bits of key material ( $128 \times 13$ ), or 52 32-bit words, while a 256-bit key would require 1920 bits of key material ( $128 \times 15$ ), or 60 32-bit words. The key expansion mechanism, then, starts with the 128-, 192-, or 256-bit Cipher Key and produces a 1408-, 1664-, or 1920-bit *Expanded Key* respectively. The original Cipher Key occupies the first portion of the *Expanded Key* and is used to produce the remaining new key material.

The result is an Expanded Key that can be 11, 13, or 15 separate keys, each used for one AddRoundKey operation. These, then, are the Round Keys. The diagram [Figure 4.25](#) shows an example using a 192-bit Cipher Key ( $N_k=6$ ). Shown in magenta italics:

<b>Expanded Key:</b>	$W_0$	$W_1$	$W_2$	$W_3$	$W_4$	$W_5$	$W_6$	$W_7$	$W_8$	$W_9$	$W_{10}$	$W_{11}$	$W_{12}$	$W_{13}$	$W_{14}$	$W_{15}$	...	$W_{44}$	$W_{45}$	$W_{46}$	$W_{47}$	$W_{48}$	$W_{49}$	$W_{50}$	$W_{51}$
<b>Round keys:</b>	Round key 0		Round key 1		Round key 2		Round key 3		...	Round key 11		Round key 12													

Figure 4.25: 192-bit Cipher key

The AddRoundKey (called Round Key addition in Rijndael) transformation merely applies each Round Key, in turn, to the State by a simple bit-wise exclusive OR operation.

**MARS: a candidate Cipher for AES, 1999** by Zunic *et al* (year)., IBM.

This new design uses a special type of a Feistel network, which depends heavily on the instruction sets available on modern 32-bit processors. This has the benefit that on these target machines it is efficient, but it may lead to implementation problems/difficulties in cheaper architectures like smart cards.

**RC6: Improved Analysis of some Simplified Variants of RC6** by Rivest, Robshaw, and Yin, RSA Laboratories.

RC6 follows the ideas of RC5 with improvements. It attempts to avoid some of the differential attacks against RC5's data dependent rotations. However, there are some attacks that are not yet employed, and it is unclear whether RC6 is well enough analysed yet.

**Serpent: A new Block Cipher Proposal** by Anderson, Biham, and Knudsen.

Serpent has a basically conservative but, in many ways innovative design. It may be implemented by bitslice (or vector) gate logic throughout. This makes it rather complicated to **write and** implement from scratch. The 32 rounds lead to probably the highest security margin on all AES candidates, while it is still fast enough for all practical purposes.

**Twofish A 128-bit Block Cipher** by Schneier *et al.*, Counterpane Security, 1998

Twofish is a block cipher designed by Counterpane, whose founder and CTO is Bruce **Schneier**. The design is highly delicate, supported with many alternative ways of implementation. It is crypt analysed in much detail, by the very authoritative "extended Twofish team". It is basically a Feistel cipher, but utilises many different ideas. This cipher has key dependent S-boxes like Blowfish (another cipher by Bruce Schneier).

## Other Symmetric Ciphers

### Blowfish

**Bruce Schneier** designed blowfish and it is a block cipher with a 64-bit block size and variable length keys (which may vary up to 448 bits). It has gained of acceptance in a number of applications, including Nautilus and PGPfone.

Blowfish utilises the idea of randomised S-boxes: while doing key scheduling, it generates large pseudo-random lookup tables through several encryptions. These tables depend on the user supplied key in a very complex manner. This makes blowfish highly resistant against many attacks such as differential and linear crypt analysis. But is not the algorithm of choice for environments where large memory space (something like 4096 bytes) is not available. The known attacks against Blowfish are based on its weak key classes.

## CAST-128

CAST -128, Substitution-Permutation Network (SPN) cryptosystem, is similar to DES, which has good resistance to differential, linear and related-key crypt analysis. CAST-128 has Feistel structure and utilises eight fixed S-boxes. CAST -128 supports variable key **lengths** between 40 and 128 bits (described in RFC214:4).

## IDEA

IDEA (International Data Encryption Algorithm), was developed at Ern Zurich in Switzerland by Xuejia **Lai** uses a 128-bit key, and is considered to be very secure. The best attacks against IDEA uses the impossible differential idea of **Biham, Shamir** and **Biryukov**. They can attack only 4.5 rounds of IDEA and this poses no threat to the total of 8.5 rounds used in IDEA. It is pertinent to note that IDEA is patented in the United States and in most European countries.

## Rabbit

Rabbit is a stream cipher, based on iterating a set of coupled nonlinear function. It is characterised by a high performance in software.

## RC4

RC4 is a stream cipher by Ron Rivest at RSA Data Security, Inc. It accepts keys of arbitrary length. It used to be a trade secret, until someone posted source code for an algorithm on the usenet, claiming it to be equivalent to RC4. The algorithm is very fast. Its security is unknown, but breaking it does not seem trivial either. Because of its speed, it may have uses in certain particular applications.

RC4 is essentially a pseudo random number generator, and the output of the generator is exclusive-ored with the data stream. For this reason, it is very important that the same RC4 key should not be used to encrypt two different data streams.



### SELF ASSESSMENT EXERCISE 8

1. What is the result of the Exclusive OR operation **1 XOR 0**

- a** 1
- b** 0
- c** Indeterminate
- d** 10

2. A block cipher:
  - a Is an asymmetric key algorithm
  - b Converts variable-length plaintext into fixed-length ciphertext (c)  
Breaks a message into fixed length units for encryption (d)  
Encrypts by operating on a continuous data stream.
  
3. What is the block length of the Rijndael Cipher?
  - a 64 bits
  - b 128 bits
  - c Variable
  - d 256 bits
  
4. What is the key length of the Rijndael Block Cipher?
  - a 56 or 64 bits
  - b 512 bits
  - c 128,192, or 256 bits
  - d 512 or 1024 bits
  
5. The NIST Advanced Encryption Standard uses the:
  - a 3 DES algorithm
  - b DES algorithm
  - c Rijndael algorithm
  - d IDEA algorithm
  - a. The modes of DES do not include:
    - a Electronic code book
    - b Variable block feedback
    - c Cipher block chaining
    - d Output feedback

### 3.3 Public Key Cryptography

Modern cryptography deals with communication between many different parties, without using a secret key for every pair of parties. In 1976, **Whitfield Diffie** and **Martin Hellman** published an invited paper in the IEEE Transactions on Information Theory titled “New Directions in Cryptography”. This paper can be considered as the beginning of modern cryptography. Their paper described a two-key crypto system in which two parties can perform a secure communication over a non-secure channel without having to share a secret key. PKC depends upon the existence of so-called one-way function, or mathematical functions that are easy to calculate but the calculation of the inverse function is relatively difficult.

Generic PKC uses two keys that are mathematically related and knowledge of one key does not allow someone to easily determine the other key. One key is used to encrypt and the other key is used to decrypt. It does not matter which key is applied

first and because a pair of keys are used, this is called asymmetric key cryptography. In PKC, one of the keys is designated as the public key and the other key is designated as the private key. The public key may be advertised but the private key is never revealed to another party. It is straightforward enough to send messages under this scheme. Suppose Alice wants to send Bob a message, Alice encrypts some information using Bob's public key; Bob decrypts the ciphertext using his private key.

The most common PKC implementation is RSA, named after the three MIT mathematicians who developed it – **Ronald Rivest, Adi Shamir, and Leonard Adleman**. RSA can be used for key exchange, digital signatures, or encryption of small blocks of data. Figures 4.21 and 4.22 highlights how digital signature are created and verified. The detailed discussion will be made in the next unit. RSA uses a variable size encryption block and variable size key. The key pair is derived from a very large number,  $n$ , that is the product of two large prime numbers selected through special rules; these primes may be 100 or more digits in length each, yielding an  $n$  with roughly twice as many digits as the prime factors. The **public** key includes  $n$  and a derivate of one of the factor of  $n$ ; an adversary cannot determine the prime factor of  $n$  (and, therefore, the private key) from this information alone and that is what makes the RSA algorithm so secure.

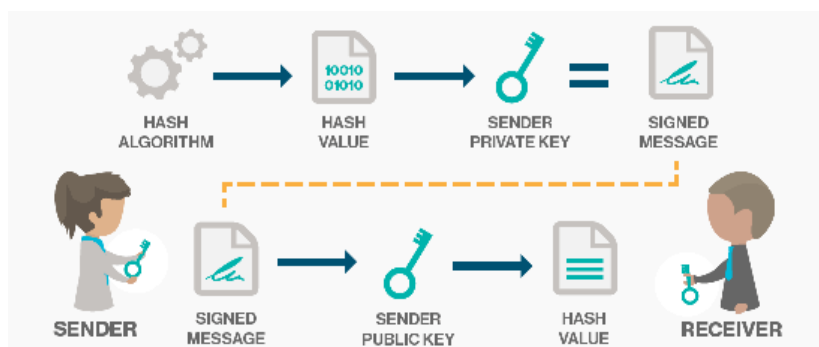

Figure 4.26: Digital Signature

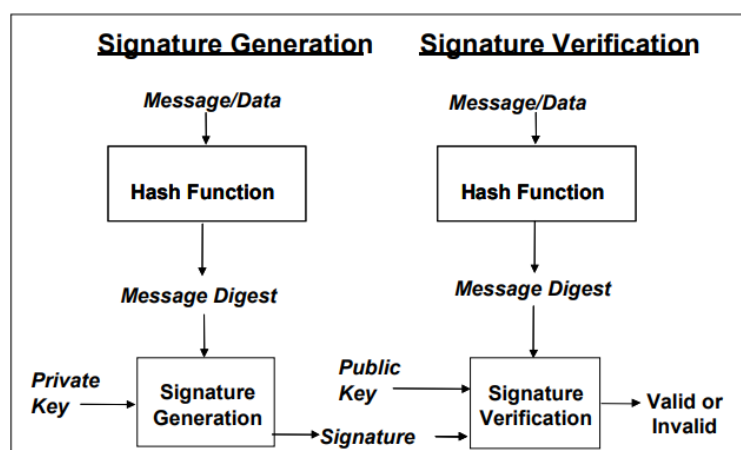

Figure 4.27: Digital signature verification process

**Goldwasser, Micali, and Rivest** gave the rigorous definition of security for signature scheme and provided the first construction that probably satisfied that definition, under a suitable assumption. The assumption that claw-free pair of permutations

exist, is implied by the assumption that integer factorisation is hard. The earlier signature scheme due to **Merkle** was also shown to satisfy this definition. **Rompel, Naor** and **Yung** showed how to construct a digital signature scheme using anyone-way function. The inefficiency of the above mentioned schemes, and due to the fact that these schemes require the signer's secret key to change between invocations of the signing algorithm make these solutions impractical.

Several other signature schemes have been shown to be secure in the so-called random-oracle model. The random-oracle model is a model of computation in which it is assumed that a given hash function behaves as an ideal random function. An ideal random function is a function where the input domain is the set of binary strings, such that each binary string is mapped to a random binary string of the same length. Although this assumption is evidently false, as it formalises the notion that the hash function is like a black box and its output cannot be determined until it is evaluated. A proof of security in the random oracle model gives some evidence of resilience to attack. The RSA signatures with special message formatting, the Fiat-Shamir, and the Schnorr signature schemes have been analysed and proven secure in the random oracle model. However, it is known that security in the random oracle model does not imply security in the plain model.

**Gennaro, Halevi, Rabin, Cramer Shoup** proposed the first signature schemes whose efficiency is suitable for practical use and whose security analysis does not assume an ideal random function. These schemes are considered to be secure, under RSA assumption.

PKC depends upon the existence of so-called one-way functions, or mathematical functions that are easy to compute whereas their inverse function is relatively difficult to compute. Let me give you two simple examples:

- 1 Multiplication vs. factorisation
- 2 Exponentiation vs. logarithms

The important Public-key cryptography algorithms are:

### **RSA**

**Diffie-Hellman:** After the RSA algorithm was published, **Diffie** and **Hellman** came up with their own algorithm. D-H is used for secret-key key exchange only, and not for authentication or digital signatures.

**Digital Signature Algorithm (DSA):** The algorithm specified in NIST's Digital Signature Standard (DSS), provides digital signature capability for the authentication of messages.

**ElGamal:** Designed by **Taher Elgamal**, is a PKC system similar to Diffie-Hellman and used for key exchange.

**Elliptic Curve Cryptography (ECC):** A PKC algorithm based upon elliptic curves. ECC can offer levels of security with small keys comparable to RSA and other PKC methods. It was designed for devices with limited compute power and/or memory, such as smartcards and **Personal Digital Assistance (PDAs)**.



**Public-Key Cryptography Standards (PKCS):** A set of interoperable standards and guidelines for public-key cryptography, designed by RSA Data Security Inc. **are:**

- 1 PKCS #1: RSA Cryptography Standard (Also RFC 3447)
- 2 PKCS #2: *Incorporated into PKCS #1.*
- 3 PKCS #3: Diffie-Hellman Key-Agreement Standard
- 4 PKCS #4: *Incorporated into PKCS #1.*
- 5 PKCS #5: Password-Based Cryptography Standard (PKCS #5 V2.0 is also RFC 2898)
- 6 PKCS #6: Extended-Certificate Syntax Standard (being phased out in favor of X.509v3)
- 7 PKCS #7: Cryptographic Message Syntax Standard (Also RFC 2315)
- 8 PKCS #8: Private-Key Information Syntax Standard
- 9 PKCS #9: Selected Attribute Types (Also RFC 2985)
- 10 PKCS #10: Certification Request Syntax Standard (Also RFC 2986)
- 11 PKCS #11: Cryptographic Token Interface Standard
- 12 PKCS #12: Personal Information Exchange Syntax Standard
- 13 PKCS #13: Elliptic Curve Cryptography Standard
- 14 PKCS #14: Pseudorandom Number Generation Standard is no longer available
- 15 PKCS #15: Cryptographic Token Information Format Standard

**Cramer-Shoup:** A public-key cryptosystem proposed by **R. Cramer** and **V. Shoup** of IBM in 1998.

**Key Exchange Algorithm (KEA):** A variation on Diffie-Hellman; proposed as the key exchange method for Capstone.

**LUC:** A public-key cryptosystem designed by **P.J. Smith** and based on Lucas sequences. Can be used for encryption and signatures, using integer factoring.

### **Public Key Infrastructure (PKI) in India**

The Act provides the Controller of Certifying Authorities (**CCA**) to license and regulate the working of **Certifying Authorities (CAs)** and also to ensure that CAs does not violate any of the provisions of the Act. CCA has created the framework for Public Key Infrastructure in India. It has prescribed technical standards for cryptography and physical security based on international standards/best practices of ITU, IETF, IEEE etc. CAs has to prove compliance with these standards through a stringent audit procedure that has been put in place. CAs also needs to get their CPS (Certification Practice Statement) approved by the CCA. India has seven Certifying Authorities: (1) SafeScript-Certifying Authority; (2) National Informatics Centre-Certifying Authority; (3) Tata Consl/Itancy- Services Certifying Authorities; (4) Institute for Research and Development in Banking Technology-Certifying Authority; (5) Customs and Central Excise-Certifying Authority; (6) Mahanagar Telephone Nigam Limited- Certifying Authority; and (7) n(Code) Solutions CA (GNFC).



The CCA also maintains the National Repository of Digital Certificates (NRDC), as required under the IT Act 2000 that contains all the certificates issued by all the CAs in India. The CCA operates its signing activity through the Root Certifying Authority of India (RCAI), which is operational under stringent controls.

Public Key Cryptosystem Asymmetric key algorithms or Public key algorithm use a different key for encryption and decryption (*Figure 4.28*), and the decryption key cannot (practically) be derived from the encryption key. Public key methods are important because they can be used to distribute encryption keys or other data securely even when the parties have no opportunity to agree on a secret key in private. All known public key methods are quite slow, and they are usually only used to encrypt session keys, that are then used to encrypt the bulk of the data using a symmetric encryption.

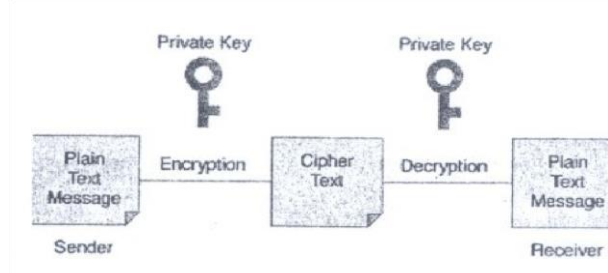

**Figure 4.28: Encryption and decryption process**

### 3.3.1 RSA Public Key Algorithm (Rivest-Shamir-Adelman Algorithm)

RSA Public Key Algorithm is the most commonly used public key algorithm and this algorithm can be used both for encryption and for signing. It is generally considered to be secure when sufficiently long keys are used (512 bits is insecure, 768 bits is moderately secure, and 1024 bits is good). The security of RSA relies on the difficulty of factoring large integers. The recent advances in factoring large integers would make RSA vulnerable. It is patented in US and the Patent expired in year 2000.

#### RSA Algorithm

##### Key Generation Algorithm

- 1 Generate two large random primes,  $p$  and  $q$ , of approximately equal size such that their product  $n = pq$  is of the required bit length, e.g., 1024 bits.
- 2 Compute  $n = pq$  and  $(\phi) \text{ phi} = (p - 1)(q - 1)$ .
- 3 Choose an integer  $e$ ,  $1 < e < \text{phi}$ , such that  $\text{gcd}(e, \text{phi}) = 1$ .
- 4 Compute the secret exponent  $d$ ,  $1 < d < \text{phi}$ , such that  $ed = 1 \pmod{\text{phi}}$ .
- 5 The public key is  $(n, e)$  and the private key is  $(n, d)$ . The values of  $p$ ,  $q$ , and  $\text{phi}$  should also be kept secret.

where

$n$  is known as the modulus.

- 1  $e$  is known as the *public exponent or encryption exponent*.  $d$  is known as the *secret exponent or decryption exponent*.

## Encryption

Sender A does the following:

- 1 Obtains the recipient B's public key  $(n, e)$ .
- 2 Represents the plaintext message as a positive integer  $m$ .
- 3 Computes the ciphertext  $c = m^e \pmod n$ .
- 4 Sends the ciphertext  $c$  to B.

## Decryption

Recipient B does the following:

- 1 Uses his private key  $(n, d)$  to compute  $m = c^d \pmod n$ .
- 2 Extracts the plaintext from the integer representative  $m$ .

### Summary of RSA

$n = pq$  where  $p$  and  $q$  are distinct primes.

$\phi = (p-1)(q-1)$   $e < \phi$   
such that  $\gcd(e, \phi) = 1$   $d = e^{-1} \pmod \phi$ .

$c = m^e \pmod n$ ,  $1 < m < n$ .  $m = c^d \pmod n$ .

## Example RSA Algorithm

Let us select two prime numbers,  $p = 7$  and  $q = 17$ . Keys are generated as follows:

1. Two prime numbers,  $p = 7$  and  $q = 17$
2.  $n = pq = 7 \times 17 = 119$
3.  $\phi(n) = (p-1)(q-1) = (7-1)(17-1) = 6 \times 16 = 96$
4. Find  $e$  which is relatively prime to  $\phi(n) = 96$  and less than  $\phi(n)$ .  
 $e = 5$  for this case
5. Find  $d$  such that  $d \cdot e = 1 \pmod 96$  and  $d < 96$   $d = 77$
6. So, public key is  $(5, 119)$  and private key is  $(77, 119)$

## Encryption and Decryption using RSA algorithm

Encryption: Let plain text input of  $M = 19$

Cipher text  $C = M^e \pmod{n}$

$$= 19^5 \pmod{119} = \frac{2476099}{119}$$

= 20807 with remainder of 66

Cipher Text  $t = 66$

### Decryption

$M = c^d \pmod{n}$

=  $66^{77} \pmod{119}$

= 19

### 3.3.2 Diffie-Hellman

Diffie-Hellman is a commonly used public-key algorithm for key exchange. It is generally considered to be secure **When** sufficiently long keys and proper generators are used. The security of Diffie-Hellman- relies on the difficulty of the discrete logarithm problem (which is believed to be computationally equivalent to factoring large integers). Diffie-Hellman is claimed to be patented in the United States, but the patent expired on April 29, 1997. There are also strong rumours that the patent might in fact be invalid (there is evidence of it having been published over an year before the patent application was led). Diffie- Hellman is sensitive to the selection of the strong prime, size of the secret exponent, and the generator.

The “Diffie-Hellman Method For Key Agreement” allow two hosts to create and share a secret key.

- 1 First, the hosts must get the “Diffie-Hellman parameters”.. A prime number, ‘p’ (larger than 2) and “base”, ‘g’, an integer that is smaller than ‘p’. They can either be hard coded or fetched from a server.
- 2 The hosts each secretly generate a private number called ‘x’, which is less than “p-1”.
- 3 The hosts next generate the public keys, ‘y’. They are created with the function:  
 $y = g^x \% p$
- 4 The two host now exchange the public keys (‘y’) and the exchanged numbers are converted into a secret key, ‘z’.  
 $z = y^x \% p$

'z' can now be used as the key for whatever encryption method is used to transfer information between the two hosts. Mathematically, the two hosts should have generated the same value for 'z'.

$$z = (g^x \% P)^y \% P = (g^y \% P)^x \% P$$

All of these numbers are positive integers

$x^y$  means: x is raised to the y power

$x\%y$  means: x is divided by y and the remainder is returned

Example:

Prime Number  $p = 353$  and primitive root of 353, in this case is  $g = 3$ . Let A is sender B is receives A & B select secret key as  $X_A = 97$  and  $X_B = 233$ . Now A & B computes their public keys.  $Y_A = 3233$ . Now A & B computes their public keys.

$$Y_A = 3^{97} \bmod 353 = 40$$

$$Y_B = 3^{233} \bmod 353 = 248$$

After exchanging their public keys, A & B can compute the common secret key:

A computes:

$$Z = (Y_B)^{X_A} \bmod 353$$

$$B \text{ computes} = 248^{97} \bmod 353 = 160$$

$$Z = (Y_A)^{X_B} \bmod 353 = 40^{233} \bmod 353 = 160$$

### 3.3.3 Elliptic Curve Public Key Cryptosystems

Elliptic Curve Public Key Cryptosystems is an emerging field. They have been slow to execute, but have become feasible with modern computers. They are considered to be fairly secure, but haven't yet undergone the same scrutiny as done on RSA algorithm.

The Public-Key cryptography systems use hard-to-solve problems as the basis of the algorithm. The most predominant algorithm today for public-key cryptography is RSA, based on the prime factors of very large integers. While RSA can be successfully attacked, the mathematics of the algorithm has not been comprised, per se; instead, computational brute-force attacks have broken the keys. The protection mechanism is "simple" – keep the size of the integer to be factored ahead of the computational curve!

In 1985, cryptographers **Victor Miller** (IBM) and **Neal Koblitz** (University of Washington) proposed the Elliptic Curve Cryptography (ECC) independently (as shown in [Figure 4.29](#)). ECC is based on the difficulty of solving the Elliptic Curve Discrete Logarithm Problem (ECDLP). Like the prime factorisation problem, ECDLP is another "hard" problem that is deceptively simple to state: Given two points, P and Q, on an elliptic curve, find the integer n, if it exists, such that  $P = nQ$ .

Elliptic curves combine number theory and algebraic geometry. ECC curves can be defined over any field of numbers (i.e., real, integer, complex), although, we

generally see them used over finite fields for applications in cryptography. An elliptic curve consists of the set of real numbers  $(x, y)$  that satisfies the equation:

$$y^2 = x^3 + ax + b$$

The set of all the solutions to the equation forms the elliptic curve. Changing  $a$  and  $b$  changes the shape of the curve, and small changes in these parameters can result in major changes in the set of  $(x, y)$  solutions.

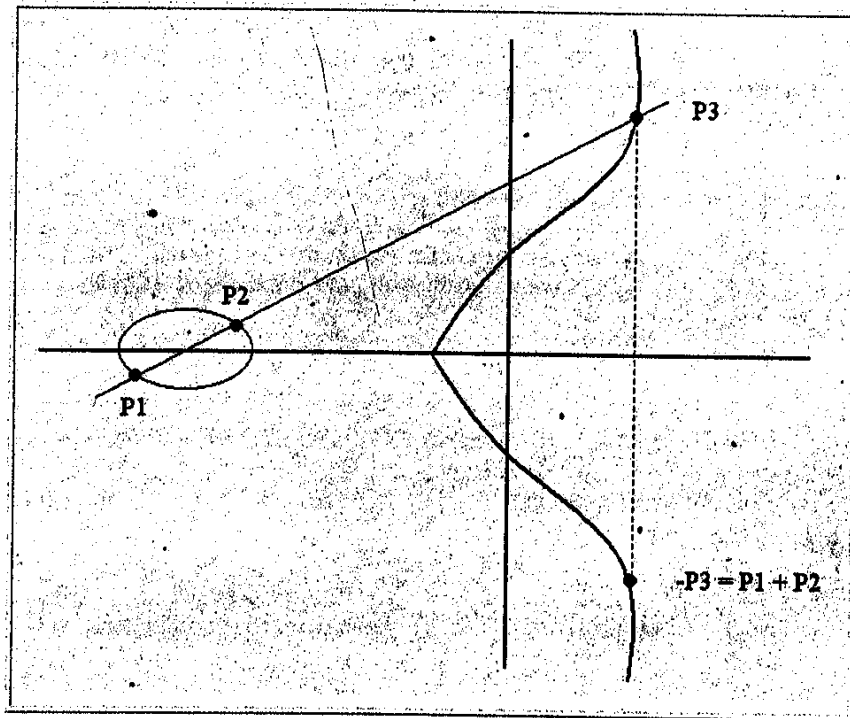

Figure 4.29: Elliptic Curve Cryptography

Figure 4.30 shows the addition of two points on an elliptic curve. Elliptic curves have the interesting property that adding two points on the elliptic curve yields a third point on the curve. Therefore, adding two points,  $P_1$  and  $P_2$ , gets us to point  $P_3$ , also on the curve. Small changes in  $P_1$  or  $P_2$  can cause a large change in the position of  $P_3$ .

Let us analyse the original problem as stated Figure 4.26. The point  $Q$  is calculated as a multiple of the starting point,  $P$ , or,  $Q = nP$ . An attacker might know  $P$  and  $Q$  but finding the integer,  $n$ , is a difficult problem to solve.  $Q$  is the public key, then, and  $n$  is the private key.

RSA has been the mainstay of PKC for over two decades. But ECC is exciting because of their potential to provide similar levels of security compared to RSA but with significantly reduced key sizes. Certicom Corp. ([http:// www.certicom.com/](http://www.certicom.com/)), one of the major proponents of ECC, suggests the key relationship between ECC and RSA as per the following figure 3.20:

RSA Key Size	Time to Break Key (MIPS Years)	ECC Key Size	RSA:ECC Key-Size Ratio
512	$10^4$	106	5:1
768	$10^8$	132	6:1
1,024	$10^{11}$	160	7:1
2,048	$10^{20}$	210	10:1
21,000	$10^{78}$	600	35:1

Figure 4.30: Relationship between ECC and RSA

Since the ECC key sizes are so much shorter than comparable RSA keys, the length of the public key and private key is much shorter in elliptic curve cryptosystems. Therefore, this results in faster processing, and lower demands on memory and bandwidth. In practice, the final results are not yet in; RSA, Inc. notes that ECC is faster than RSA for signing and decryption, but slower than RSA for signature verification and encryption.

Nevertheless, ECC is particularly useful in applications where memory, bandwidth, and/or computational power is limited (e.g., a smartcard) and it is in this area that ECC use is expected to grow.

### 3.3.4 DSA

#### DSS (Digital Signature Standard)

A signature-only mechanism endorsed by the United States Government. Its design has not been made public, and many people have found potential problems with it (e.g., leaking hidden data, and revealing your secret key if you ever happen to sign two different messages using the same random number).

The DSA is used by a signatory to generate a digital signature on data and by a verifier to verify the authenticity of the signature. Each signatory has a public and private key. The private key is used in the signature generation process and the public key is used in the signature verification process. For both signature generation and verification, the data which is referred to as a message,  $M$ , is reduced by means of the Secure Hash Algorithm (SHA) specified in FIPS YY. An adversary, who does not know the private key of the signatory, cannot generate the correct signature of the signatory. In other words, signatures cannot be forged. However, by using the signatory's public key, anyone can verify a correctly signed message.

A means of associating public and private key pairs for the corresponding users is required. That is, there must be a binding of a user's identity and the user's public key. A mutually trusted party may certify this binding. For example, a certifying authority could sign credentials containing a user's public key and **identity** to form a certificate. Systems for certifying credentials and distributing certificates are beyond the scope of this standard. NIST intends to publish separate document(s) on certifying credentials and distributing certificates.

The DSA makes use of the following parameters:

- 1  $p =$  a prime modulus, where  $2^{L-1} < P < 2^L$  for  $512 \leq L \leq 1024$  and  $L$  a multiple of 64
- 2  $q =$  a prime divisor of  $p-1$ , where  $2^{159} < q < 2^{160}$
- 3  $g = h^{(p-1)/q} \bmod p$ , where  $h$  is any integer with  $1 < h < P - 1$  such that  $h^{(p-1)/q} \bmod p > 1$  ( $g$  has order  $q \bmod p$ )
- 4  $x =$  a randomly or pseudorandomly generated integer with  $0 < x < q$
- 5  $y = g^x \bmod p$
- 6  $k =$  a randomly or pseudorandomly generated integer with  $0 < k < q$

The integers  $p$ ,  $q$ , and  $g$  can be public and can be common to a group of users. A user's private and public keys are  $x$  and  $y$ , respectively. They are normally fixed for a period of time. Parameters  $x$  and  $k$  are used for signature generation only, and must be kept secret. Parameter  $k$  must be regenerated for each signature.

The signature of a message  $M$  is the pair of numbers  $r$  and  $s$  computed according to the equations below:

$$r = (g^k \bmod p) \bmod q \text{ and}$$

$$s = (k^{-1}(\text{SHA}(M) + xr)) \bmod q.$$

In the equation,  $k^{-1}$  is the multiplicative inverse of  $k$ , mod  $q$ ; i.e.,  $(k^{-1} k) \bmod q = 1$  and  $0 < k^{-1} < q$ . The value of  $\text{SHA}(M)$  is a 160-bit string output by the Secure Hash Algorithm specified in FIPS 180. For use in computing  $s$ , this string must be converted to an integer.

As an option, one may wish to check if  $r = 0$  or  $s = 0$ . If either  $r = 0$  or  $s = 0$ , a new value of  $k$  should be generated and the signature should be recalculated (it is extremely unlikely that  $r = 0$  or  $s = 0$  if signatures are generated properly).

The signature is transmitted along with the message to the verifier.

Prior to verifying the signature in a signed message,  $p$ ,  $q$  and  $g$  plus the sender's public key and identity are made available to the verifier after proper authentication.

Let  $M'$ ,  $r'$  and  $s'$  be the received versions of  $M$ ,  $r$ , and  $s$ , respectively, and let  $y$  be the public key of the signatory. To verify first check to see that  $0 < r' < q$  and  $0 < s' < q$ ; if either condition is violated, the signature shall be rejected. If these two conditions are satisfied, the verifier computes:

$$w = (s'r \bmod q)$$

$$u_1 = ((\text{SHA}(M')w) \bmod q) u_2$$

$$= ((r')w) \bmod q$$

$$v = (((g)^{u_1} (y)^{u_2}) \bmod p) \bmod q.$$

If  $v = r^s$ , then the signature is verified—and the verifier can have high confidence that the received message was sent by the party holding the secret key  $x$  corresponding to  $y$ . For a proof that  $v = r^s$  when  $M^s = M$ ,  $r^s = r$ , and  $s^s = s$ , see Appendix 1 of [ref 2].

If  $v$  does not equal  $r^s$ , then the message may have been modified, the message may have been incorrectly signed by the signatory, or the message may have been signed by an impostor. The message should be considered invalid.

**ElGamal** public key cryptosystem. Based on the discrete logarithm problem.

ElGamal consists of three components: the key generator, the encryption algorithm, and the decryption algorithm.

The key generator works as follows:

Alice generates an efficient description of a cyclic group  $G$  of order  $q$  with generator  $g$ . See below for specific examples of how this can be done.

Alice chooses a random  $x$  from  $\{0, \dots, q-1\}$ .

Alice computes  $h = g^x$ .

Alice publishes  $h$ , along with the description of  $G, q, g$ , as her public key, Alice retains  $x$  as her secret key.

The encryption algorithm works as follows: to encrypt a message  $m$  to Alice under her public key  $(G, q, g, h)$ ,

Bob converts  $m$  into an element of  $G$ .

Bob chooses a random  $k$  from  $\{0, \dots, q-1\}$ , then calculates  $c_1 = g^k$  and  $c_2 = m \cdot h^k$

Bob sends the ciphertext  $(c_1, c_2)$  to Alice.

The decryption algorithm works as follows: to decrypt a ciphertext  $(c_1, c_2)$  with her secret key  $x$ ,

Alice computes  $c_2 c_1^{-r}$  as the plaintext message.

Note that the decryption algorithm does indeed produce the intended message since:

$$c_2 c_1^{-r} = \frac{m \cdot h^k}{g^k} \cdot \frac{1}{g^{kx}} = \frac{m \cdot h^k}{g^{k(1+x)}} = m \pmod{q}$$

If the space of possible messages is larger than the size of  $G$ , then the message can be split into several pieces and each piece can be encrypted independently. Typically,



however, a short key to a symmetric-key cipher is first encrypted under ElGamal, and the (much longer) intended message is encrypted more efficiently using the symmetric-key cipher – this is termed hybrid encryption.

### 3.4 Mathematical Background

In this section, we will find out mathematical background from mathematical Algorithms.

#### 3.4.1 Exclusive OR (XOR)

Exclusive OR (XOR) is one of the fundamental mathematical operations used in cryptography (and many other applications). **George Boole**, a mathematician in the late 1800s, invented a new form of “algebra” that provides the basis for building electronic computers and microprocessor chips. **Boole** defined a bunch of primitive logical operations where there are one or two inputs and a single output depending upon the operation; the input and output are either TRUE or FALSE. The most elemental Boolean operations are:

NOT: The output value is the inverse of the input value (i.e., the output is TRUE if the input is false, FALSE if the input is true).

AND: The output is TRUE if all inputs are true, otherwise FALSE. (e.g., “the sky is blue AND the world is flat” is FALSE while “The sky is blue AND security is a process” is TRUE.)

OR: The output is TRUE if either or both inputs are true, otherwise FALSE. (e.g., “the sky is blue OR the world is flat” is TRUE and “the sky is blue OR security is a process” is TRUE).

XOR (Exclusive OR): The output is TRUE if exactly one of the inputs is TRUE, otherwise FALSE. (e.g., “the sky is blue XOR the world is flat” is TRUE while “the sky is blue XOR security is a process” is FALSE.)

In computers, Boolean logic is implemented in logic gates; for design purposes, XOR has two inputs and a single output, and its logic diagram looks like this:

XOR	0	1
0	0	1
1	1	0

So, in an XOR operation, the output will be a 1 if one input is a 1; otherwise, the output is 0. The real significance of this is to look at the “identity properties” of XOR. In particular, any value XORed with itself is 0 and any value XORed with 0 is just itself. Why does this matter? Well, if I take my plaintext and XOR it with a key, I get a jumble of bits. If I then take that jumble and XOR it with the same key, I return to the original plaintext.

### 3.4.2 The Modulo Function

The *modulo* function is, simply, the remainder function. It is commonly used in programming and is critical to the operation of any mathematical function using digital computers.

To calculate  $X \text{ modulo } Y$  (usually written  $X \text{ mod } Y$ ), you merely determine the remainder after removing all multiples of  $Y$  from  $X$ . Clearly, the value  $X \text{ mod } Y$  will be in the range from 0 to  $Y-1$ .

Some examples should clear up any remaining confusion:

$$\begin{aligned} 1 \text{ mod } 7 &= 1 \\ 25 \text{ mod } 5 &= 0 \\ 33 \text{ mod } 12 &= 9 \\ 203 \text{ mod } 256 &= 203 \end{aligned}$$

Modulo arithmetic is useful in crypto because it allows us to set the size of an operation and be sure that we will never get numbers that are too large. This is an important consideration when using digital computers.

1. Which of the following is an example of a symmetric key algorithm?
  - a RSA
  - b Diffie-Hellman
  - c Knapsack
  
2. Which of the following is a problem with symmetric key algorithms?
  - a It is slower than asymmetric key encryption
  - b Most algorithms are kept proprietary
  - c Work factor is not a function of the key size.
  - d It provides secure distribution of the secret key.
  
3. Which of the following is an example of an asymmetric key algorithm?
  - a ELLIPTIC CURVE
  - b IDEA
  - c 3 DES
  - d DES
  
4. In public key cryptography:
  - a Only the public key can encrypt, and only the private can decrypt
  - b Only the private key can encrypt, and only the public can decrypt
  - c The public key is used to encrypt and decrypt
  - d If the public key encrypts, and only the private can decrypt.
  
5. In a block cipher, diffusion:

- a** Conceals the connection between the ciphertext and plaintext
  - b** Spread the influence of a plaintext character over many ciphertext characters.
  - c** Cannot be accomplished
  - d** Is usually implemented by non-linear S-boxes.
6. State whether following statements are True or False. T O F 0
- a** Work factor of double DES is the same as for single DES
  - b** Elliptic curve cryptosystem have a lower strength per bit than RSA.
  - c** In digitally-signed message transmission using a hash function the message digest is encrypted in the public key of the sender.



#### 4.0 CONCLUSION

In this unit you have learnt about the fundamental problems in networking which is network security. You have therefore been taken through the principles and practice of cryptography and the various related algorithms.



#### 5.0 SUMMARY

Information security can be defined as technological and managerial procedures applied to computer systems to ensure the availability, integrity, and confidentiality of the information managed by computer. Cryptography is a particularly interesting field because of the amount of work that is, by necessity, done in secret. The irony is that today, secrecy is not the key to the goodness of a cryptographic algorithm. Regardless of the mathematical theory behind an algorithm, the best algorithms are those that are well known and well documented because they are also well tested and well studied! In fact, time is the only true test of good cryptography; any cryptographic scheme that stays in use year after year is most likely to be a good one. The strength of cryptography lies in the choice and management of the keys; longer keys will resist attack better than shorter keys.

With the introduction of IT Act 2000, the electronic transactions and electronically signed documents are valid under the court of law. Use of PKI in India is expected to increase rapidly and for activation of global e-commerce and so also the use of digital signatures within domestic and other Global PKI domains. This requires the interoperability of PKI based applications.

Digitisation of information, networking, and WWW (**World Wide Web**), has changed the economics of information. The Copyright Act 1957 as amended up to 1999 takes care of the technological changes that still require major amendments in order to deal with the challenges posed by the computer storage, Internet and the digital revolution. With India being party to Trade Related Aspects of Intellectual Properties (TRIPs), electronic transactions of IPRs and consultancy services related to them is expected to be a new possibility in India. This may also promote our technology base to keep

pace with global trends. As India has already enacted IT Act 2000, this allows transactions signed electronically for e-commerce primarily to be enforced in a court of law. Several issues arise when we consider using digital documents and exchanging them over the Internet, such as eavesdropping, tampering, impersonation etc. All these can be remedied with the use of public key infrastructure (PKI). However, the question of the time when a document was created may be answered by using Digital Time stamping service, which is based on PKI. This information may prove to be crucial for most e-commerce legally binding transactions, in particular for supporting non-repudiation of digitally signed transactions.



## 6.0 TUTOR MARKED ASSIGNMENT 15

1. What is cryptography?
2. List the various requirements of application-to-application communication.
3. List various types of cryptographic techniques.



## 7.0 REFERENCES/FURTHER READINGS

Willam Stallings, *Network Security Essential- Application and standard*, Pearson Education, New Delhi.

A.S. Tanenbaum, (2011). *Computer Networks*, 4<sup>th</sup> Edition, Practice Hall of India, New Delhi.

## 8.0 ANSWERS TO TUTOR MARKED ASSIGNMENT 15

### Question 1

What is cryptography?

### Solution

This the method of converting ordinary plaintext to an unintelligible text and vice versa or is the science of writing secret codes.

### Question 2

List the various requirements of application-to-application communication.

### Solution

The various requirements of application-to-application communication are:

- a. Authentication
- b. Privacy/ confidentiality
- c. Integrity
- d. Non-repudiation.

### **Question 3**

List various types of cryptographic techniques.

### **Solution**

The various types of cryptographic techniques are:

- a. access control
  - b. digital signatures
  - c. e-mail security
  - d. password authentication
  - e. data integrity check
  - f. digital evidence collection
- copyright protection.

## **8.0 ANSWERS TO SELF-ASSESSMENT EXERCISE 8**

### **Question 1**

What is the result of the Exclusive OR operation IXORO?

- (a) 1✓
- (b) 0
- (c) Indeterminate
- (d) 10

### **Question 2**

A block cipher:

- (a) Is an asymmetric key algorithm
- (b) Converts variable-length plaintext into fixed-length ciphertext✓
- (c) Breaks a message into fixed length units for encryption
- (d) Encrypts by operating on a continuous data stream.

### **Question 3**

What is the block length of the Rijndael Cipher?

- (a) 64 bits
- (b) 128 bits✓
- (c) Variable
- (d) 256 bits

### **Question 4**

What is the key length of the Rijndael Block Cipher?

- (a) 56 or 64 bits
- (b) 512 bits
- (c) 128,192, or 256 bits✓
- (d) 512 or 1024 bits

### **Question 5**

The NIST Advanced Encryption Standard uses the:

- (a) 3 DES algorithm
- (b) DES algorithm
- (c) Rijndael algorithm✓
- (d) IDEA algorithm

### **Question 6**

The modes of DES do not include:

- (a) Electronic code book
- (b) Variable block feedback✓
- (c) Cipher block chaining
- (d) Output feedback

## **UNIT 4 NETWORK SECURITY-II**

### **CONTENTS**

- 1.0 Introduction
- 2.0 Objectives
- 3.0 Main Content
  - 3.1 Digital Signatures'
  - 3.2 Management of Public Keys
  - 3.3 Communication Security
  - 3.4 Web Security
- 4.0 Conclusion
- 5.0 Summary
- 6.0 Tutor-Marked Assignment
- 7.0 References/Further Readings



### **1.0 INTRODUCTION**

Computer security and network security can be defined as technological and managerial procedures applied to computer and network systems to ensure the availability, integrity, and confidentiality of the information managed by the computer. It implies the protection of Integrity, Availability and Confidentiality of Computer Assets and Services from associated Threats and vulnerabilities. Protection of networks and their services from unauthorised modification, destruction, or disclosure and the provision of assurance that the network will perform its critical functions correctly and that there will be any harmful side effects. The major points of weakness in a computer system are hardware, software, and data. However, other components of the computer system may also be targeted.

In this unit, we deal with advance topics of Network Security. In Section 4.2, we define digital signatures. Section 4.3 deals with management of public keys, section 4.4 presents a brief review of communication security. In section “4.5, we discuss

web security. We summarise this unit in section 4.6 followed by Solutions and Answers for ‘Check Your Progress’.



## 2.0 OBJECTIVES

The objective of this unit is to provide a practical survey of both the principles and practice of Digital Signature. After going through this unit you should be able to understand:

- digital Signature
- public Key Infrastructure
- management of Public Keys
- communication and Web Security.



## 3.0 MAIN CONTENT

### 3.1 Digital Signatures

Digital signatures are based on public key cryptography. A private key is used to create a digital signature and the public key is used to verify the digital signature. The Hash value of a message when encrypted with the private key of a person is his digital signature on that e-Document. The Digital Signature of a person therefore, varies from document to document, thus, ensuring authenticity of each word in that document. As the public key of the signer is known, anybody can verify the message and the digital signature. The 4.31 shows the process of creating a digital signature. The hash function is applied to the plain text which is further encrypted **with** the private key of a sender for creating a digital signature.

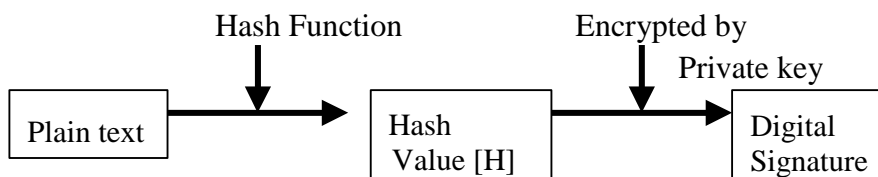

Figure 4.31: Digital signature

The Figure 4.32 shows how one key is used for encryption and another key is used for decryption. The Figure 4.33 shows that a person is having two keys in public key cryptography.

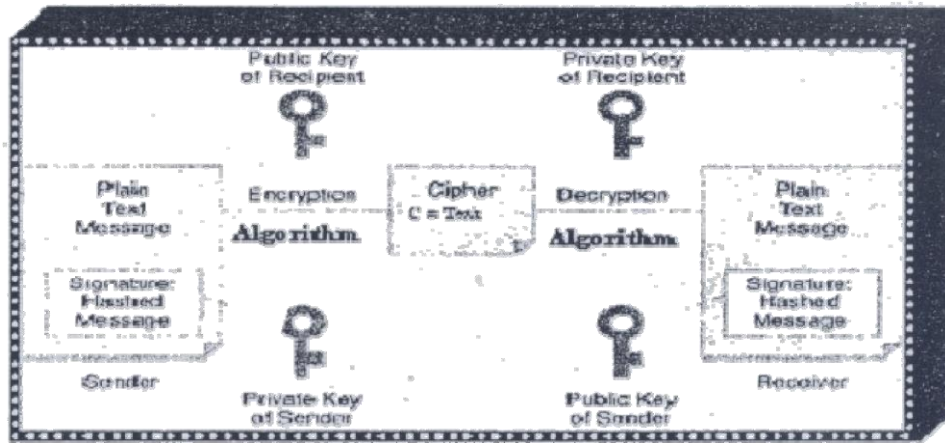

Figure 4.32: Encryption and signing using public key cryptography

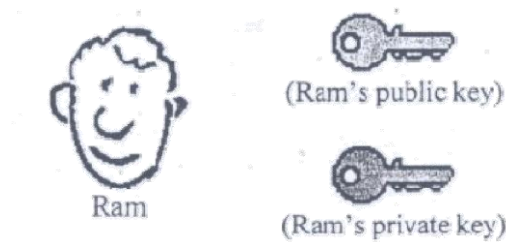

Figure 4.33: Explanation using an example

**Ram has been given two keys. One of Ram's Key is called the Public key, and the other is a Private Key**

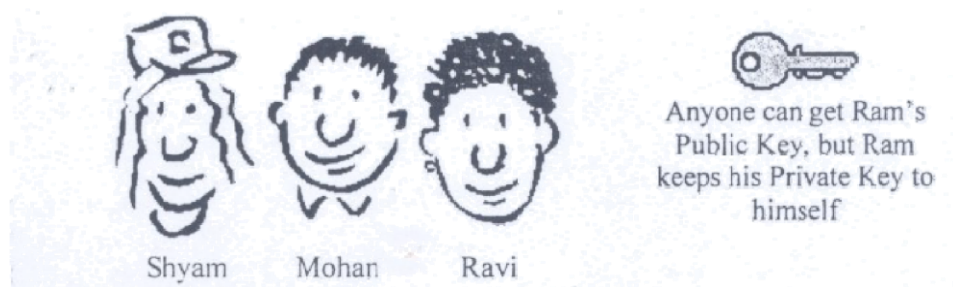

Figure 4.34: Ram's co-workers

Ram's Public key is available to anyone who needs it (Figure 4.34), but he keeps his Private Key to himself. Keys are used to encrypt information. Encrypting information means "scrambling it up", so that only the person with the appropriate key can make it readable again. One of Ram's two keys can encrypt the data, while the other key can decrypt that same data.

Ravi (Figure 4.35) can encrypt a message using Ram's Public Key. Ram uses his Private Key to decrypt the message. Any of Ram's co-workers might have access to the message Ravi encrypted, but without Ram's Private Key, the data is worthless.





Figure 4.35: Encryption of a message using public key of Ram

With his private key and the right software, Ram can put digital signatures on documents and other data. A digital signature is a “stamp” Ram places on the data which is unique to Ram, and is very difficult to forge. In addition, the signature assures that any changes made to the data that has been signed will not go undetected.

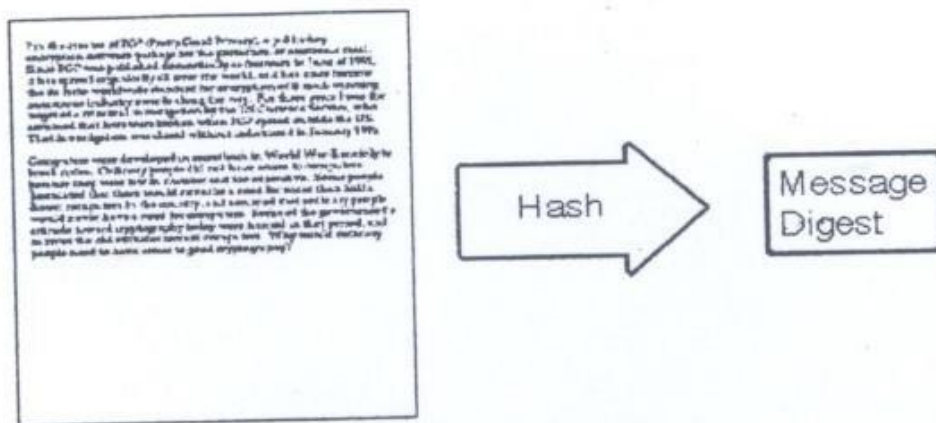

Figure 4.36: Hashing and Manage Digest

To sign a document, Ram’s software will crunch down the data into just a few lines by a process called “hashing” (Figure 4.36). These few lines are known as a message digest. (It is not possible to change a message digest back into the original data from which it was created, as Hash is a one way function).

To sign a document, Ram’s software will crunch down the data into just a few lines by a process called “hashing” (Figure 4.36). These few lines are known as a message digest. (It is not possible to change a message digest back into the original data from which it was created, as Hash is a one-way function).

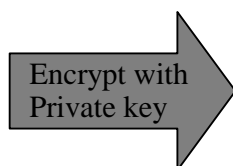



Figure 4.37: Encryption of message digest using prey

Ram’s software then encrypts (Figure 4.37) the message digests with his private key. The result is the digital signature.

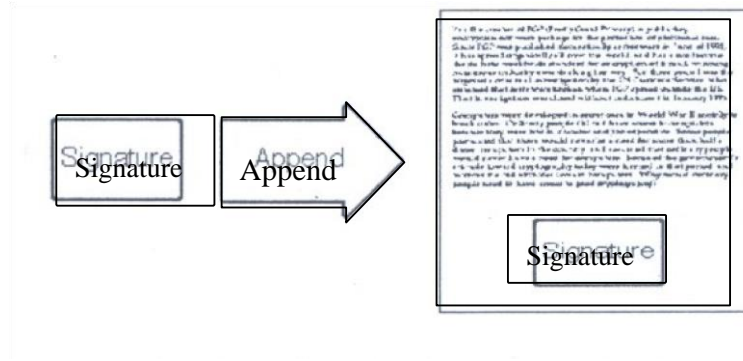

Figure 4.38: Append the digital signature to the document

Finally, Ram’s software appends (Figure 4.38) the digital signature to the document. All the data that was hashed has been signed (figure 4.38).

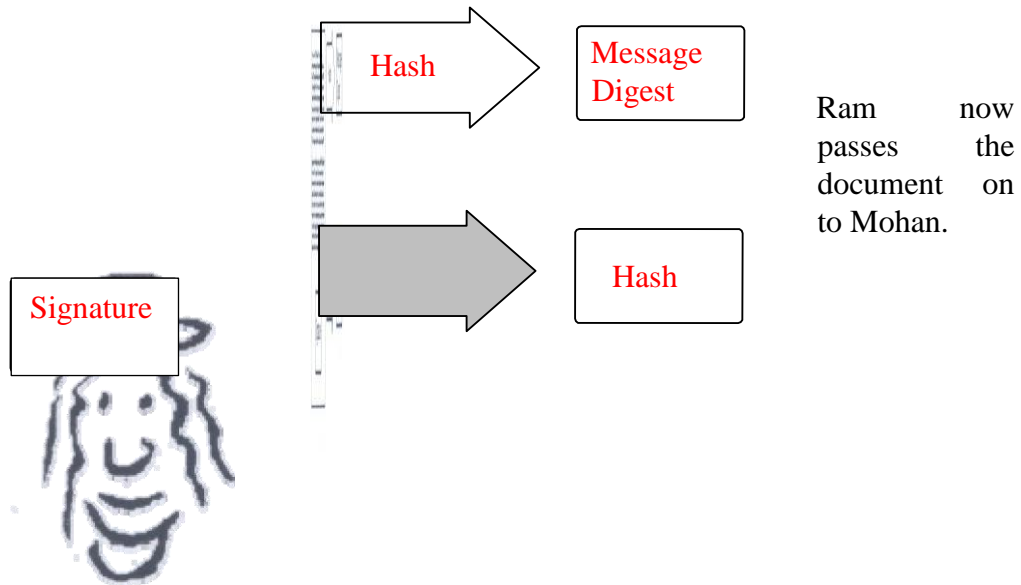

Figure 4.39: The decryption using public key

Shayam’s software decrypts the signature in public changing it back into a Signature message digest. If this work, then it proves that Ra m has signed the document, because only Ram h this private key. Mohan’s software then hashes as t document data into a message digest. If the he message digest is the same as the message digest created when the signature was decrypted, then Mohan knows that the signed data has not been changed/tampered with.



Mohan (our disgruntled employee) wishes to deceive Shayam. Mohan makes sure that Shayam receives a signed message and a public key that appears to belong to Ram. Unknown to Shayam, Mohan deceitfully sends a key pair he has created using Ram's name. Short of receiving Ram's public key from him in person, how can Shayam be sure that Ram's public key is authentic?

It so happens that Ravi works at the company's certificate authority centre. Ravi can create a digital certificate for Ram by using Ram's public key as well as some information (figure 4.39).

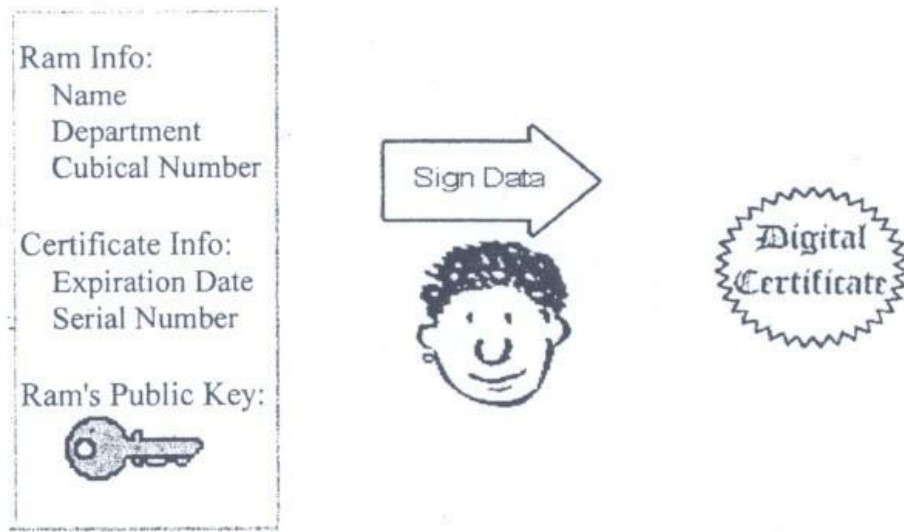

Figure 4.40: Creation of a digital certificate

Ram's co-workers can verify Ram's trusted certificate to make sure that his public key truly belongs to him. In fact, no one at Ram's company accepts a signature for which there does not exist a certificate generated by Ravi. This gives Ravi the power to revoke signatures if private keys are compromised, or no longer needed. There are even more widely accepted certificate authorities that certify Ravi.

If Ram sends a signed document to Shayam, to verify the signature on the document, Shayam's software first uses Ravi's (the certificate authority's) public key to check the signature on Ram's certificate. Successful de-encryption of the certificate proves that Ravi created it. After the certificate is de-encrypted, Shayam's software can check if Ram is in good standing with the certificate authority and that the certificate information concerning Ram's identity has not been altered.

Shayam's software then takes Ram's public key from the certificate and uses it to check Ram's signature. If Ram's public key de-encrypts the signature successfully, then Shayam is assured that the signature was created using Ram's private key, for Ravi has certified the matching public key. And of course, if the signature is valid, then we know that Mohan didn't try to change the signed content.

## Digital Certificate

This is a certificate issued by the Certifying Authority (figure 4.40) to the holder of the public key. The contents of a digital certificate are issued by a CA as, a data message and is always available online.

Sr. No of the Certificate

Applicant's name, Place and Date of Birth, Name of the Company

Applicant's legal domicile and virtual domicile

Validity period of the certificate and the signature

CA's name, legal domicile and virtual domicile

User's public key

Information indicating how the recipient of a digitally signed document can verify the sender's public key

CA's digital signature.

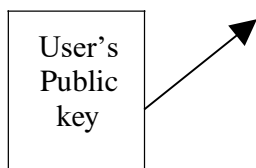
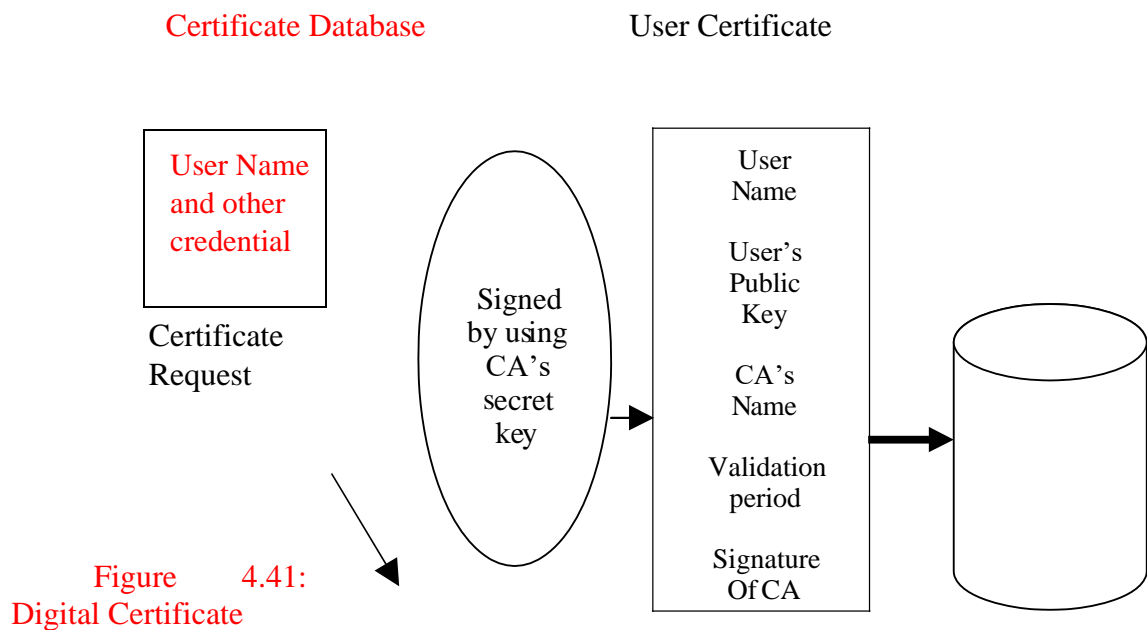

**Figure 11: Issuing of a digital certificate by the certifying authority Uses of Digital Signature**

**Contracts**

The next time you purchase a car, a home, or an insurance policy, you may never need to meet with an agent or sales representative. You may be able to review and sign all documents online, and save secure backup copies to your own disk.

## **Cheques and money orders**

Buying online is now easy with a credit card, but digital **Cheques** or money orders (authenticated by secure digital signatures) may be preferable for some transactions, especially when you don't want to face a large credit card bill.

## **Letters and memos**

Businesses already transmit many letters and memos online, especially those that are only distributed internally. But when a letter or memo needs the weight of a manager's signature, it must be printed, signed, duplicated, and distributed manually or through the mail. Digital signatures will save companies the time and expense of this manual process.

## **Approvals**

Many kinds of documents are collaborative works, such as legal briefs, contracts, reports, and others. Using digital signatures, people can collaborate on documents online and approve final drafts, before/prior to releasing them for use.



### **SELF ASSESSMENT EXERCISE 9**

- 1 What does the Electronic Signatures in Global and National Commerce Act do?
- 2 What does a signature mean?
- 3 Why are handwritten signatures a drawback in some types of transactions?
- 4 What is a digital signature?
- 5 What are the benefits of using digital signatures?

## **3.3 Management of Public Keys**

### **Public Key Infrastructure**

The integration of Digital Signatures and Certificates and the other services required for E-Commerce is known as Public Key Infrastructure (PKI). These services provide integrity, access control, confidentiality, authentication, and non-repudiation for electronic transactions and communications. The PKI includes the followings: Digital certificates, Certificate authority (CA), Registration authority, policies and procedures, Certificate revocation, Non-repudiation support, Time stamping, Lightweight Directory Access Protocol (LDAP), and Security-enabled applications.

The Digital certificate and management of the certificate are the main components of PKI. The purpose of the digital certificate is to verify individual public key. This certificate is accomplished by digitally signing the individual's public key and associated information using the Private Key. A CA (Certification Authority) acts as the notary for verifying a person's identity and issuing a certificate that vouches for the public key of the individual concerned. The CA signs the certificate with its own private key. The certificate is then sent to a

repository, which holds the certificates and **Certificate Revocation Lists (CRLs)** that denote the revoked certificates.

Certificate and CRLs can be held in a repository, with well-defined responsibilities shared by both the repository and the CA. Hierarchical model followed in India is shown in **Figure 4.42**.

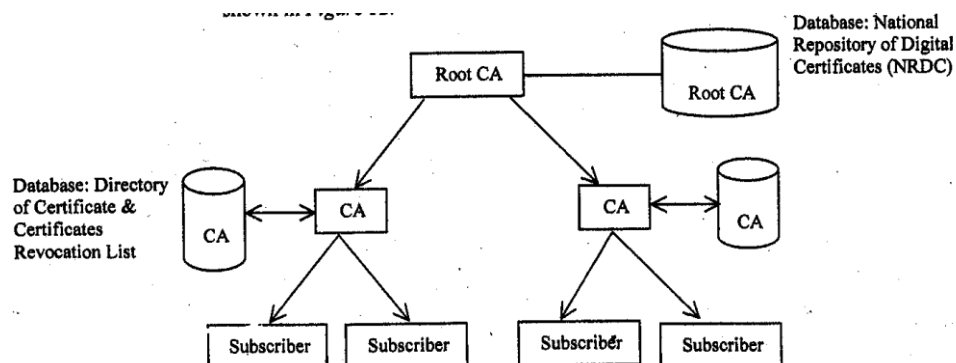

**Figure 4.42: Hierarchical model being followed in India**

## Directories and x.500

The repository (or directory) contains entries associated with an object class. An object class can be an individual or other computer related entry. The X.509 certificate standard defines the **authentication** base for the X.500 directory. The X.500 directory stores information on objects in a distributed database that resides on the network server. Some of the principle definitions associated with X.500 include: the following: Directory user agent (DUAs)-clients, Directory server agents (DSAs)- servers, Directory service protocol (DSP)-enables information exchanges between DSAs, **Directory** access protocol (DAPs)-enables information exchanges from a DUA to a DSA, and Directory information shadowing protocol (DISP)- useable information exchanges from a DUA to a DSA. DSAs accept request from anonymous source as well as authenticated requests. They share information through a chaining mechanism.

## Lightweight Directory Access Protocol

The Lightweight directory access protocol (LDAP) was developed as a more efficient version of DAP and has evolved into a second version (Yeong, Y. T. Howes, and S.Killie, Lightweight Directory Access Protocol, RFC 1777, 1995). LDAP servers communicate through referrals. If it finds the directory with the required entry, it sends a referral to the requesting directory. DAP v2 does not have chaining and shadowing capabilities, but additional protocol can be obtained to provide these functions.

LDAP provides a standard format for accessing certificate directories. These directories are stored on the network LDAP servers and provide public keys and corresponding X.509 certificates for the enterprise. A directory contains information such as an individual's name, address, phone number, and public key certificate. The standard under X.500 defines the protocols and information models for computer directory services that are independent of the platforms and

other related entities. LDAP servers are subject to attacks that affect availability and integrity. For example, Denial of Service attacks on an LDAP server could prevent access to the CRLs and thus, permit the use of a revoked certificate. The DAP protocol in X.500 was unwieldy and led to most client implementations using LDAP. LDAP version 3 is under development; it will include extensions that provide shadowing and chaining capabilities.

## X.509 Certificates

The original X.509 certificate (CCITT, The Directory-Authentication Framework, Recommendation X.509, 1988) was developed to provide authentication foundation for the X.500 directory. Since then, a version 2, version 3, and recently, a version 4 have been developed. Version 2 of the X.509 certificates address the reuse of names, version 3 provides for certificate extensions to the core certificate fields, and version 4 provides additional extensions. These extensions can be used as needed by different users and different applications. A version of X.509 that takes into account the requirements of the internet was published by the IETF (Housley, R. W. Ford, W. Polk, and D. Solo, Internet X.509 public Key Infrastructure Certificate and CRL Profile, RFC 2459, 1999).

The Consultation Committee, International Telephone and Telegraph, International Telecommunications Union (CCITT -ITU)/International Organization for standardization (ISO) has defined the basic format of an X.509 certificate. This structure is outlined in the Figure 4.43.

Version
Serial Number
Algorithm Identifier <ul style="list-style-type: none"> <li>• Algorithm</li> <li>• Parameters</li> </ul>
Issuer
Period of Validity
Subject
Subject's Public Key <ul style="list-style-type: none"> <li>• Public Key</li> <li>• Algorithm</li> <li>• Parameters</li> </ul>
Signature

Figure 4.43: The CCITT-ITU/ISO X.509 certificate format

If version 3 certificates are used, the optional extensions field can be used. It is before the signature field components in the certificate. Some typical extensions are the entity's name and supporting identity information, the attributes of the key, certificate policy information, and the type of subject. The digital signature serves as a tamper-evident envelope.

Some of the different types of certificates that are issued include the following:

### CA certificates



Issued to CAs, these certificates contain the public keys used to verify digital signatures on CRLs of all the certificates.

### End entity (EE) certificates

Issued to entities that are not CAs, these certificates contain the public keys that are needed by the certificate's user in order to perform key management or verify a digital signature.

### Self-issued (self-signed) certificates

These certificates are issued by an entity to itself to establish points of trust and to distribute a new signing public key.

### Rollover certificates

A CA issues these certificates for transition from an old public key to a new one.

### Certificate Revocation Lists

The user checks the certificates revocation list (CRL) to determine whether a digital signature has been revoked. They check for the serial number of the signature. The CA signs the CRL for integrity and authentication purpose. A CRL is shown in the Figure 4.44 given below for an X.509 version 2 certificates.

Version
Serial Number
Issuer
thisupdate(issue date)
nextupdate (date by which the next CRL will be issued)
revoked certificates (list of revoked certificates)
crlExtensions
SignatureValue

Figure 4.44: CRL format (version 2)

The CA usually generates the CRLs for its population. If the CA generates the CRLs for its entire population, the CRL is called a full CRL.

### Key Management

Obviously, when dealing with encryption keys, the same precaution must be used as with physical keys to secure the areas or the combinations to the safes. The components of key management are listed as follows:

### Key Distribution



As noted earlier, distributing secret keys in symmetric key encryption poses a problem. Secret keys can be distributed using asymmetric key cryptosystem. Other means of distributing secret keys include face-to-face meeting to exchange keys, sending the keys by a secure messenger, or some other secure alternate channel. Another method is to encrypt the secret key with another key, called a key encryption key, and send the encrypted key to the intended receiver. These key encryption keys can be distributed manually, but they need not be distributed often. The X9.17 Standard (ANSI X9.17 [Revised],” American National Standard for Financial Institution Key Management [Wholesale],” American Bankers Association, 1985) specifies key encryption keys as well as data keys for encrypting the plaintext messages.

Splitting the keys into different parts and sending each part by a different medium can also accomplish key distribution.

In large networks, key distribution can become a serious problem because in an N-person network, the total number of key exchanges is  $N(N-1)/2$ . Using public key cryptography or the creation and, exchange of session keys that are valid only for a particular session and time are useful mechanism for managing the key distribution problem. Keys can be updated by generating a new key from an old key.

### **Key Revocation**

A digital certificate contains a timestamp or period for which the certificate is valid. Also if the key is compromised or must be made invalid because of business-or personal-related issues, it must be revoked. The CA maintains a CRL of all invalid certificates. The user should regularly examine this list.

### **Key Recovery**

A system must be put in place to decrypt critical data if the encryption key is lost or forgotten. One method is key escrow. In this system, the key is subdivided into different parts, each of which is encrypted and then sent to a different trusted individual in an organization. Keys can also be escrowed onto smart cards.

### **Key renewal**

Obviously, the longer a secret key is used without changing it, the more it is subject to compromise. The frequency with which you change the key is a direct function of the value of the data being encrypted and transmitted. Also, if the same secret key is used to encrypt valuable data over a relatively long period of time, you risk compromising a larger volume of data when the key is broken. Another important concern if the key is not changed frequently is that an attacker can intercept and change messages and then send different messages to the receiver. Key encryption keys, because they are not used as often as encryption keys, provides some protection against attacks. Typically, private keys used for digital signatures are not frequently changed and may be kept for years.

### **Key destruction**

Keys that have been in use for long periods of time and are replaced by others should be destroyed. If the keys are compromised, older messages sent with those keys can be read.

Keys that are stored on disks or EEPROMS should be overwritten numerous times. One can also destroy the disk by shredding and burning them. However, in some cases, it is possible to recover data from disks that were put into fire. Any hardware device storing the keys, such as an EEPROM, should also be physically destroyed.

Older Keys stored by the operating system in various locations in the memory must also be searched and destroyed.

### **Multiple Keys**

Usually an individual has more than one public/private key pair. The keys may be of different sizes for different levels of security. A larger key size may be used for digitally signing documents and smaller key size may be used for encryption. A person may also have multiple roles or responsibilities wherein he/she may want to sign messages with a different signature. One key pair may be used for business matters, another for personal use, and another for some other activity, such as being a school board member.

### **Distributed vs Centralized Key Management**

A CA is a form of centralized key management. It is a central location that issues certificates and maintains CRLs. An alternative is the distributed key management, in which a “chain of trust” or “web of trust” is set up among users who know each other. Because, they know each other, they can trust that each one’s public key is valid. Some of these users may know other users and thus, verify their public key. The chain spreads outward from the original group. This arrangement results in an informal verification procedure that is based on people knowing and trusting each other.

## **3.3 Communication Security**

This section describes authentication mechanism to support application- level authentication and digital signatures. We will describe kerberos mechanism in the following paragraphs.

### **Kerberos**

Kerberos is a commonly used authentication scheme on the Internet. Developed by MIT’s Project Athena, Kerberos is named after the three- headed dog who, according to Greek mythology, guards the entrance of Hades (rather than the exit, for some reason!).

Kerberos (as shown in [Figure 4.45](#)) employs a client/server architecture and provides user-to-server authentication rather than host-to-host authentication. In this model, security and authentication will be based on a secret key technology where every host on the network has its own secret key. It would clearly be

unmanageable if every host had to know the keys of all other hosts so, a secure, trusted host somewhere on the network, known as a Key Distribution Centre (KDC), knows the keys of all the hosts (or at least some of the hosts within a portion of the network, called a *realm*). In this way, when a new node is brought online, only the KDC and the new node need to be configured with the node's key; keys can be distributed physically or by some other secure means.

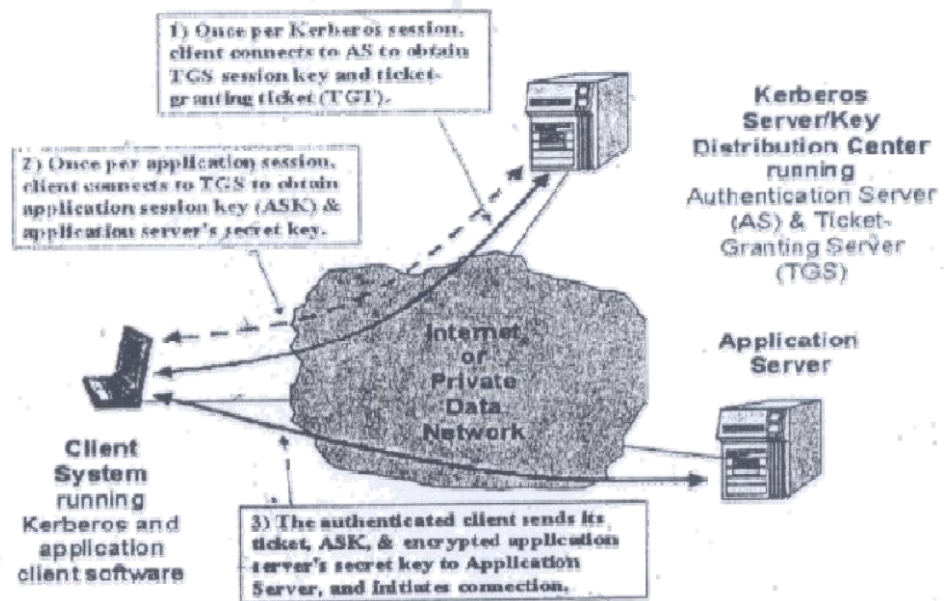

Figure 4.45: Kerberos

The Kerberos Server/KDC has two main functions (Figure 4.45), known as the Authentication Server (AS) and Ticket-Granting Server (TGS). The steps in establishing an authenticated session between an application client and the application server are:

The Kerberos client software establishes a connection with the Kerberos server's AS function. The AS firstly authenticates that the client is who it purports to be. The AS then provides the client with a secret key for this login session (the TGS session key) and a ticket-granting ticket (TGT), which gives the client permission to talk to the TGS. The ticket has a finite lifetime so that the authentication process is repeated periodically.

The client now communicates with the TGS to obtain the Application Server's key so that it (the client) can establish a connection with the service it wants. The client supplies the TGS with the TGS session key and TGT; the TGS responds with an application session key (ASK) and an encrypted form of the Application Server's secret key; this secret key is never sent on the network in any other form.

The client has now authenticated itself and can prove its identity to the Application Server by supplying the Kerberos ticket, application session key, and encrypted Application Server secret key. The Application Server responds with similarly encrypted information to authenticate itself to the client. At this point, the client can initiate the intended service requests (e.g., Telnet, FTP, HTTP, or e-commerce transaction session establishment).

Electronic mail is the most heavily used network-based application. It is also the only distributed application that is widely used across all architectures and vendor platforms. With the explosively growing reliance on electronic mail, there is a concern for authentication and confidentiality of service. Two approaches, pretty good privacy (PGP) and **Secured Multipurpose Internet Mail Extension. (S/MIME)** are widely used for this purpose.

## PGP

PGP is largely the effort of a single person, **Phil Zimmermann**, and provides a confidentiality and authentication service that can be used for electronic mail and file storage applications. **Zimmermann** has done the following:

Selected the best available cryptographic functions as building blocks, integrated these functions into general purpose application that is independent of operating system and processor,

Made the package and documentation, including source code, freely available via the Internet, bulletin boards, and commercial networks, and

Also made the Commercial versions easily available.

The actual operation of PGP consists of five services: authentication, confidentiality, compression, e-mail compatibility, and segmentation. A brief summary of PGP services is described in the **figure 4.46**:

Function	Algorithms Used	Description
Digital Signature	DSS/SHA or RSA/SHA	A hash value of the message is generated using SHA-1 algorithm. This hash value is encrypted using DSS or RSA with the sender's private key, and included with the message
Message Encryption	CAST or IDEA or 3DES with Diffie-Hellman or RSA	A message is encrypted using CAST-128 or IDEA or 3DES with a one-time session key generated by the sender. The session key is encrypted using Diffie Hellman or RSA with the recipient's public key, and attached to the message.
Compression	ZIP	A message may be compressed, for storage or transmission, using ZIP
Email-Compatibility	Radix-64-conversion	To provide transparency for e-mail applications, an encrypted message may be converted to an ASCII string using radix-64 conversion.
Segmentation		To accommodate maximum message size limitations, PGP performs segmentation and reassembly.

**Figure 4.46: Services of PGP**

## S/MIME

S/MIME (Secure/Multipurpose Internet Mail Extension) is a security enhancement to the MIME Internet e-mail format standard, based RSA data security technology. Though both S/MIME and PGP are based on IETF standards,

S/MIME is industry standard for commercial and organizational use, and PGP is a choice for personal e-mail security for many users.

MIME is an extension to the RFC 822 framework (traditional email format standard) that is intended to address some of the problems and limitations of the use of SMTP (simple mail transfer protocol) or some other mail transfer protocol and RFC 822.

### **Virtual Private Network (VPN)**

The VPN has become the de facto standard for secure remote access. It provides business partners access to corporate network resources across un-trusted networks. Typically, the untrusted network will be the Internet, but VPNs offer excellent flexibility and can also be used across more traditional network mediums such as frame relay or **ATM** networks. VPNs guarantee the confidentiality and integrity of corporate data through the use of strong encryption and authentication techniques. VPNs have become famous because of excellent cost saving and performance improvements in comparison to more traditional remote access methods. **Types of VPN**

VPNs are of two distinct categories: (1) Site to site VPNs, between two or more offices or data centres; (2) Client to site VPNs, between a desktop client and a central office or data centre.

### **IPSec**

Most clients to site VPNs are based on **IPSec** (short for IP Security), which is a suite of protocols developed by the IETF to support secure transmission of packets at the IP layer. Typically, an IPSec tunnel connection will be created from a Client software component to a VPN gateway (or firewall with VPN functionality). Following the initialization of this tunnel, all packets destined for the remote corporate network will be routed through this tunnel. The tunnel provides the necessary security, by encrypting each packet (using one of a selection of algorithms) before forwarding it to the remote gateway. When packets reach the remote gateway, they are decrypted and then forwarded 'in the clear' to the final destination.

IPSec was initially devised for site to site VPN connections, so in order to add the necessary functionality to IPSec to allow effective client to site connections and management, each vendor has added vendor specific features to its **IPSec** implementation. Good examples of this include Check Point hybrid mode (to allow strong user authentication without certificates) and **NAT** traversal techniques from the majority of vendors.

As shown in the **Figure 4.47**, IPSec clients work by adding extra functionality at the bottom of the IP Layer. This functionality inspects traffic, and encapsulates and encrypts traffic as necessary.

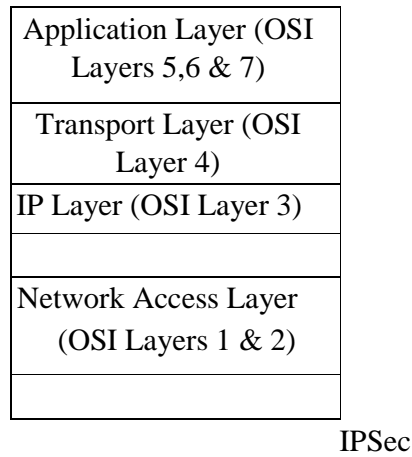

Figure 4.47: Functionality inspects traffic, and encapsulates and encrypt traffic Secure Sockets Layer (SSL)

Netscape originated SSL. Secure Sockets layer is a protocol, which is already imbedded in most IP stacks and placed at the base of the application layer, as shown in the Figure 4.48. SSL has been traditionally and widely deployed for securing web-based applications in the form of HTTPS (or secure HTTP). Even the most novice users are normally aware of the padlock symbol shown on secure web sites, even if they are unaware of the fact that this symbol means that” the site is protected by SSI.

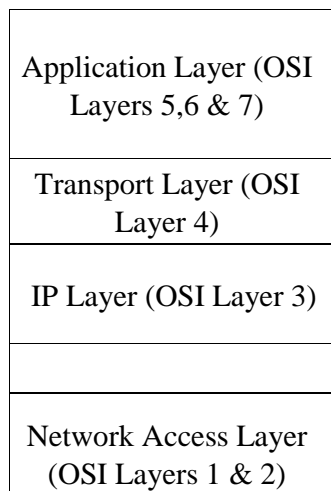

Figure 4.48: Secure socket layer (SSL).

Some SSL VPNs claim to have clientless or near clientless operation. This means access to the VPN can be created from any machine with a Web browser,

including machines in Internet cafe's and home machines. The main drivers for SSL VPN are: Cost saving; independent platform and mobility.

### **Cost saving**

Because SSL VPNs can be clientless, the cost of deploying clients is saved. For large organizations this can be a large outlay.

### **Independent Platform & mobility**

Access can be granted from many types of machine (Linux, Windows, PDAs) and from many locations.

With these benefits, SSL VPNs also has many complications and disadvantages.

### **Benefits of SSL**

#### **Cost saving**

Because SSL VPNs can be clientless, the cost of deploying clients is saved.

#### **Platform independence/independent platform**

Access can be granted from many types of machines with different operating systems (Linux, Windows 2K/XP, Apple Mac, Palm OS, windows 7, windows 8, windows 10, Symbian, Pocket PC).

#### **Client type mobility**

Although IPSec clients can grant access across most mediums (Leased line, DSL, Dial, GPRS) they only offer access from the corporate desktop on which the client is installed. SSL VPNs can be configured to allow access from corporate built laptops, home desktops, customer or supplier desktops or any machine in an Internet cafe. This extra choice allows a much wider audience (i.e., non-laptop users) to improve productivity and work from anywhere (at home or while traveling).

#### **Client IP mobility**

Although widespread deployment is yet to take hold, mobile IP network deployment is growing steadily. A side effect of a mobile IP network is that the client's source address can change as a client moves between cells and networks. This has the effect of breaking an IPSec VPN connection, but because SSL VPNs are not bound to the source IP address, connections can be maintained as clients move. No NA Tissues-Traditionally Hide Network Address Translation Hide NAT) has caused issues with IPSec VPNs. Vendors have generally overcome these issues by developing vendor specific NAT traversal mechanisms based on Payload encapsulation in UDP packets. Although these mechanisms normally



function well, they break and cause interoperability problems between vendors deployments. SSL VPNs do not suffer such issues because they are not tied to the IP layer.

### **Granular access control**

Although IPSec VPNs also offer highly granular access control through machine and the service it provides, SSL VPNs can offer a greater degree of granularity, even as far as the URL. SSL VPNs also lend themselves to more granular access control because each resource accessed must be explicitly defined. This differs from IPSec VPN because the entire corporate network can be defined with a single statement.

### **Restrictive firewall rules**

Organizations with a reasonable security infrastructure employs a firewall rule set with limits outbound access. SSL based VPNs communicate on the port used by Secure HTTP (TCP port 443), which is one of the few ports allowed outbound access from any machine in the corporate network in most environments. Even if the proxy cache servers are deployed, since the HTTPS traffic is encrypted, as a result, this encrypted traffic will pass un-inspected. This is not possible with IPSec based VPN.

As stated above in the [Figure 4.48](#) SSL VPNs make use of the existing SSL functionality that are already present in most IP Stacks. Because SSL fits into the stack between layers 4 and 5, each application must explicitly define its use. Based on this fact, SSL VPNs fall into 3 distinct categories: (i) **Application** layer proxies, (ii) Protocol redirectors, and (iii) Remote control enhancers. Commercial SSL products are combination of the above-mentioned techniques.

These techniques are discussed below:

#### **1 Application layer proxies**

Application layer proxies are the simplest form of SSL VPNs because they rely on the SSL functionality used by existing applications. Because of this, application layer proxies have the least application support. Generally, they only support Email and Web-based traffic. They function by using the SSL setup in existing applications, for example, you would web browse to the gateway which will then proxy web traffic internally (using a simple method to display links to internal systems). To use the email, your administrators would configure the SSL functionality in your email client and proxy all email traffic via the gateway.

One of the advantages of application layer proxies are that they are truly clientless. They operate with nearly all operating systems and web browsers.

#### **2 Protocol redirectors**

Protocol redirectors have more flexibility than application layer proxies, but they are truly clientless in their operation. Protocol redirectors work by downloading a



mini client from the gateway, which is installed locally and redirects traffic. The redirection is depicted in [Figure 4.49](#).

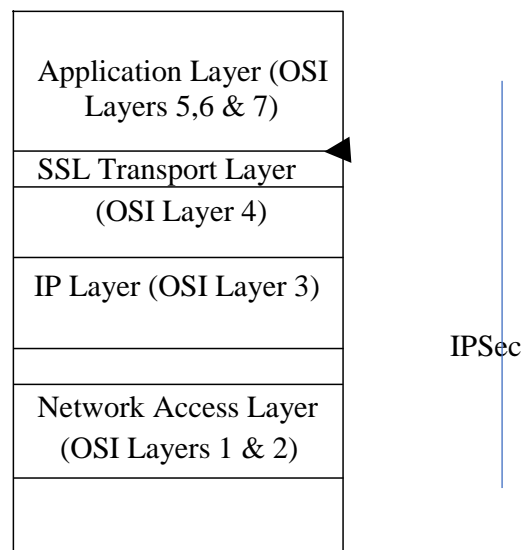

**Figure 4.49: Protocol redirector**

For example, if a connection is made through an application, which does not use the SSL layer, the connection is captured at the base of the IP layer and then encapsulated within an SSL tunnel. Once the traffic reaches the SSL gateway, it is decrypted and then proxied to the original destination.

The only realistic method of capturing the traffic on the way through the IP stack is to redirect traffic based on name resolution to a local resource. For example, to connect to <http://mail.yahoo.com>, the port redirector is enabled, then the name [mail.yahoo.com](http://mail.yahoo.com) will be forced to connect to the localhost (127.0.0.1) through the use of a host file. This means that the mini client must have the ability to write changes to the hosts file, which at a **hardened** desktop may not always be possible. Also, in most implementations, some administrative permission is required on the local desktop to install the mini client, which is rarely possible using a machine in an Internet Café.

The main advantage of the protocol redirection system is that it can support any application that works on fixed TCP or UDP ports and in which some implementations, and applications with dynamic port applications can be supported (such as MS Outlook).

### **3. Remote Control Enhancers**

Remote control enhancers are the most flexible form of SSL based VPN, but they also have heavy overload. They work by enhancing a remote control protocol like Windows Terminal Services or Citrix Metaframe and adding SSL VPN functionality and Web Browser support. This means any application can be added to the SSL VPN by adding the application to the remote control desktop. As a stand-alone application, this has serious limitations, because applications that

reside on the local desktop cannot be used directly. This is why most remote control enhancers are partnered with other SSL VPN technologies.

On the positive side though, they can offer features like the ability to read and update a documents held centrally without ever having to download the entire document. While travelling and using VPN over low speed connections, or when connection quality is poor this could be a better option, because connections are restarted without losing any work.

## **Technical Issues**

### **Other technical considerations include**

Performance; high availability; and network performance.

#### **Performance**

SSL VPNs can support large number of concurrent users with adequate performance.

#### **High Availability**

Most vendors (especially the ones with more mature products) are able to perform some form of internal High Availability and fail over mechanisms.

Network Performance: Performance over a low speed link (GSM data or GPRS) should be good to accept the mobility aspect of SSL VPNs. It has been noticed that SSL VPNs can offer some performance advantages over IPsec VPNs. Not considering the setup operations, which can be considered “one time” for a relatively short-lived connection, the overhead of IPsec on a packet is between 50 and 57 octets (including the new IP header, the ESP header and the trailers), representing a 10% increase on an average packet (500 byte). In contrast to this, SSL VPNs add only 5 octets of data to each packet, just a 1% increase on the average packet. However, setup operations cannot be ignored, but these are roughly similar in size for IPsec and SSL connections. Also, because SSL VPNs work at a much higher layer, they suffer far less from, the packet fragmentation issues normally associated with IPsec VPNs. Finally, SSL has an in-built compression mechanism.

## **Deployment Considerations and Disadvantages of SSL VPNs**

### **Application Support**

The main hurdle to deployment of SSL VPNs is likely to be application support. As SSL works at the boundary of layers 4 and 5, each application must support its use. Vendors add additional support through the use of protocol redirectors, but these often require some user knowledge to operate. Based on this, the first step to take when designing an SSL VPN solution is to look at the access that will be required and assess how simple this will be to provide.

### **Internal Network Security Failings**

With IPsec VPN, a large number of organisations allocate specific IP addresses to remote clients' systems using the RADIUS Protocol. This gives the ability to filter and control traffic based on the IP source, ensuring internal network security. As all sessions from an SSL VPN are normally proxied from a single address, all clients' sessions originate from this single IP. Due to this, a network administrator is unable to allocate privileges using source IP addresses. In reality, this level of control can be handled on the SSL VPN gateway, but if a network is already configured to some IP source-based security, the overhead of altering it, can be very high.

### **Audit and Activity Awareness**

Any security appliance, hardware or software system should include a good level of auditing. With SSL VPN this functionality is seen as the key, because of the relatively simple systems needed to abuse an SSL VPN by a remote hacker (i.e., a web browser), should logon credentials become compromised. Further to this, some form of real time alerting of unusual actions (such as trying to copy an entire disk over the VPN) must be included. Some of this functionality is seen by vendors, as fewer keys and, is still evolving.

### **Client Security**

As SSL VPN offers a much greater choice of client platform with 'clientless' or 'near clientless' operation, the security of any client connecting to the network must be scrutinised. For example, in no way would any organisation consider a PC in an Internet cafe to be as trusted as a corporate issued laptop. Due to this, vendors have developed several mechanisms to boost the trust associated with an un-trusted client connection. Some of these are outlined below:

#### **1. Client Integrity Scanning**

When a client connects to the VPN a small java applet is downloaded to the client machine, which searches for good or bad files, process or ports listening. For example, it can check for a running AV program with current definitions, the presence of a personal firewall with a standard rule set or the presence of any known Trojans. The disadvantage of this mechanism is it may place limitations on the types of clients that can connect, but more importantly, it is only a onetime snapshot of a system. Also with an understanding of the rule set, it seems feasible that these checks may be fooled.

#### **2. Sandbox**

A sandbox is used to store any files downloaded from a corporate network over the SSL VPN. Once the VPN session is terminated, the contents of the sandbox are securely deleted. This avoids issues of email attachments and corporate data being accidentally left on un-trusted machines. Sandboxes can also be used to ensure Citrix Metaframe or other interactive session data is wiped from a machine at logoff.

#### **3. Secure logoff and credential wiping**

This ensures that when users logoff the system all logon credentials are wiped from the client machine. Of course, with enterprise strength VPN solution, a strong authentication mechanism should also be used to protect credentials further.

#### **4. Timeouts and Re-authentication**

To avoid systems being left connected to the network by users, sessions can be terminated after periods of inactivity. Also, to ensure that the correct user is still using the connection, periodic authentication during a session can be implemented on client systems.

#### **5. Virus, Malicious Code and Worm Activity**

As the client is nearly un-trusted, most SSL VPNs can also filter traffic at the application level (especially if an application level proxy is used, rather than a protocol redirector), blocking worms and viruses at the gateway. SSL VPNs used for remote access, no doubt, have significant advantages over the IPSec alternatives. But the advantages they offer also add complexity, which must be weighed against the advantages. Before considering an SSL VPN deployment you should consider: security risks involved; added mobility and flexibility; protocol support required.

### **3.4 Web Security**

With the transformation of the Internet from a network used primarily by universities and research laboratories to a world-wide communications medium, attacks on the World Wide Web and Internet can be have very serious consequences. In today's environment virtually all businesses, government agencies, and many individuals now have their own web sites. But Internet and Web are extremely vulnerable to compromises of various sorts. As a result demand for secure web services grows. Thus, there is a need for protecting nodes on the Internet and for providing for the confidentiality, integrity, and availability of information utilising these networks.

#### **Web Security Considerations**

WWW is fundamentally a client/server application running over the Internet and TCP/IP intranet. This presents new challenge:

The web is vulnerable to attacks on the Web server over the Internet.

Reputation can be damaged and money can be lost if the Web servers are subverted, as it serves as a highly visible outlet for corporate and product information.

The history of the web show that even upgraded, properly installed systems are vulnerable to a variety of security attacks.

#### **SSL/TLS**

The Secure Sockets Layer (SSL) protocol was developed by Netscape in 1994 to protect the confidentiality of information transmitted between two applications, to verify the integrity of communication and to provide authentication means in both directions. SSL implements these functions using public and private key encryption and a message authentication code (MAC).

Microsoft has developed a newer version of SSL, Transport Layer security (TLS). As with SSL, TLS includes confidentiality, integrity and authentication above the transport layer and is application independent. Because SSL and TLS ride on the transport layer protocol, they are independent of the application. Thus, SSL and TLS can be used with application such as telnet, FTP, HTTP and email protocol.

Both SSL and TLS use certificates for public key verification that are based on the X.509 standard. **SSL 3.0**

The design goals of SSL 3.0 were to provide:

- 1 **Cryptographic Security:** Protection of the confidentiality of transmitted messages.
- 2 **Interoperability:** Application should be able to be developed using SSL 3.0 by groups of individuals without knowledge of each other's code.
- 3 **Extensibility:** The ability to incorporate different encryption algorithm into SSL 3.0 without major changes to SSL 3.0.
- 4 **Relative Efficiency:** Efficient utilisation of computing and network resources.

Session keys generated during SSL private key cryptography transaction are either 40-bits or 128-bits in length. Newer browsers support 128-bit encryption. The SSL protocol comprises two layers, the SSL Record Protocol and the SSL Handshake Protocol. The SSL Record Protocol is layered above a transport protocol, such as TCP. This record protocol is used for encapsulation of higher-level-protocols, such as the SSL Handshake protocol. The latter protocol is used for client/server mutual authentication, negotiation of a cryptographic algorithm, and exchange of cryptographic keys.

Thus, through these mechanisms, SSL provides:

- 1 Mutual authentication using public key cryptography based on algorithms, such as, the Digital Signature Standard (DSS) and RSA.
- 2 Encryption of messages using private key cryptography based on algorithm, such as, IDEA, 3DES, and RC4.
- 3 Integrity verification of the message using a keyed message authentication code (MAC) based on hash functions, such as, MD5 and SHA.

## **TLS 1.0**

Similar to SSL, the TLS protocol is comprised of the TLS Record and Handshake Protocols. The TLS Record Protocol is layered on top of a transport protocol such as TCP and provides privacy and reliability to the communications. The privacy

is implemented by encryption using symmetric key cryptography (DES or RC4). A new secret key is generated for each connection; but, the Record Protocol can be used without encryption. Integrity is provided through the use of a MAC (Message Authentication Code) using hash algorithms such as SHA or MD5.

The TLS Record Protocol is also used to encapsulate a higher-level protocol such as the TLS Handshake Protocol. The server and client use this Handshake Protocol to authenticate each other. The authentication can be accomplished using asymmetric key cryptography (RSA or DSS). The Handshake Protocol also sets up the encryption algorithm and cryptographic keys to enable the application protocol to transmit and receive information.

Since TLS is based on SSL, they have similar functionality and goals; however, SSL and TLS have enough differences that they cannot interoperate. In order to address this situation, TLS through built-in mechanism becomes compatible with SSL 3.0.

## **S-HTTP**

Secure HTTP (S-HTTP) is a communication protocol for providing secure messaging over HTTP. S-HTTP provides, equal and symmetric capabilities to both client and server, but when an entity that is S-HTTP enabled communicates with another entity that is not S-HTTP capable, the secure features will not work. S-HTTP implements secure, end-to-end transactions. S-HTTP supports a symmetric key encryption only mode, and therefore, does not require public key encryption for key exchanges. It is flexible, but permits the clients and servers to use different forms of transactions related to the signing of messages, encryption of messages, algorithms used, and types of certificates. S-HTTP protocol supports the following:

- Option negotiations for defining the type of transactions desired,
- A variety of key management mechanisms,
- Various trust models,
- Multiple cryptographic algorithms,
- Multiple operation modes, and
- Different encapsulation formats.

## **Instant Messaging**

Instant messaging supports the real time exchange of messages between two parties using the Internet. To use this service, the user has to have instant messaging client software on his or her computer system. The client software then communicates with an instant messaging server. Some popular messaging utilities are the freeware ICQ (for “I seek you” at [www.Icq.com](http://www.Icq.com)), AIM (America Online’s Instant Messenger), Microsoft’s instant messaging utility in MSN Explorer, and Yahoo Instant Messenger.

One problem with instant messaging is lack of interoperability. A person with an instant messaging utility from one source or vendor may not be able to communicate with a person using a different instant messaging package. To solve

this problem, the Internet Engineering Task force (IETF) has developed a standard protocol for instant messaging- the Instant Messaging Presence Protocol.

### **IM Vulnerabilities**

Messages sent through the instant messaging protocol are not inherently secure and safe. The instant messaging server is vulnerable because it contains both the messages and the connection information of the user. Thus, instant messaging servers should be secure servers located in protected and limited access areas. In addition to that, some of the security features provided by some instant messaging software utilities include:

encryption, integrity, and authentication services using SSL,  
authentication against propriety databases, domains, or LDAP, secure  
transfer of files, ability to use any TCP port,

web-based tools for administration of the instant messaging network on the instant messaging server, including tools for user account administration, logging of critical data, and analysis of log information.

### **Naming Conventions**

New Technology File Systems (NTFS) has the capability to generate names in the DOS 8.3 naming convention to service 16-bit application that access files that do not conform to DOS 8.3 naming. Windows 2000, Windows NT, and Windows NT Workstation support the NTFS file system. Windows 95/98 support, the earlier FAT file system along with the FAT 32, new version. The NTFS enhancement over FATIFAT32 includes optimisation of available disk space, fault tolerance, and improved security features.

Web servers that respond to requests for files in their DOS 83 fields names are vulnerable to attacks that can cause the server to reveal source code. A fix to this problem is, to disable DOS 8.3 file name creation on the NTFS server, but this may result in difficulties in using 16-bit applications.



## **4.0 CONCLUSION**

In this concluding unit of this course you have been taken through digital signature, public key infrastructure, management of public keys as well as web security. It is our belief that with what you have learnt in this course you will be able to show your own among dfgt professionals and build upon it.



## **5.0 SUMMARY**

Computer and Network security relates to technological and Managerial procedures applied to a computer, computer system, computer network to ensure the availability, integrity and confidentiality of data. In this unit covered various

aspects of digital signatures, management of public keys, public key infrastructures in Nigeria Communication and web security etc.



## 6.0 TUTOR MARKED ASSIGNMENT 16

1. What is X.509 certificate?
2. List components of a X.509 Certificate and CRL certificate.
3. List all Certification Authorities Operating in India.
4. Which choice below most accurately describes SSL?
  - a It's a widely used standard of securing email at the Application level.
  - b It gives a user remote access to a command prompt across a secure, encrypted session.
  - c It uses two protocols, the Authentication header and the Encapsulating Security Payload.
  - d It allows an application to have authenticated, encrypted communication across a network.
5. List differences between SSL and TLS.
6. What is S-HTTP?
7. What are instant messaging and its vulnerabilities?



## 7.0 REFERENCES/FURTHER READINGS

William Stallings, *Network Security Essential – Application and standard*, Pearson Education, New Delhi, 2003.

A.S. Tanenbaum, *Computer Networks*. 4. Edition, Practice Hall of India, New Delhi, 2011.

## 8.0 ANSWERS TO SELF ASSESSMENT EXERCISE 9

### Question 1

What does the Electronic Signatures in Global and National Commerce Act do?

### Solution

The Electronic Signatures in Global and National Commerce Act (E-Sign Act), 1 signed into law on June 30, 2000, provides a general rule of validity for electronic records and signatures for transactions in or affecting interstate or foreign commerce. The E-Sign Act allows the use of electronic records to satisfy any statute, regulation, or rule of law requiring that such information be provided in writing, if the consumer has affirmatively consented to such use and has not withdrawn such consent (<https://www.fdic.gov/regulations/compliance/manual/10/x-3.1.pdf>).

### Question 2



What does a signature mean?

**Solution**

This is an individual handwriting written in a unique form as a means of identification in giving permission for a document or to end a written letter.

**Question 3**

Why are handwritten signatures a drawback in some types of transactions?

**Solution**

Handwritten signatures are a drawback in some types of transactions because;

- a. It can be easily forged
- b. It wastes to time before distributing electronically
- c. It is costly to get the manual signature signed electronically
- d. It is very cumbersome to be used for electronic transaction

**Question 4**

What is a digital signature?

**Solution**

A **signature**, or digital **signature**, is a protocol showing that a message is authentic. From the hash of a given message, the signing process first generates a digital **signature** linked to the signing entity, using the entity's private key

(<https://developer.mozilla.org/en-US/docs/Glossary/Signature/Security#:~:text=A%20signature%2C%20or%20digital%20signature,using%20the%20entity's%20private%20key.>)

**Question 5**

What are the benefits of using digital signatures?

**Solution**

The benefits of using digital signatures are that:

1. They give rooms for more efficient and secure workplace
2. Assist organization save time
3. Assist organization save money and space giving room for better **security** while increasing output and reducing paperwork.

**9.0 ANSWERS TO TUTOR-MARKED ASSIGNMENT 16**

**Question 1**

What is X.509 certificate?

### Solution

This is a standard format for public key certificates which its original X.509 certificate (CCITT, The Directory-Authentication Framework, Recommendation X.509, 1988) was developed to provide authentication foundation for the X.500 directory. Each X.509 *certificate* includes a public key, identifying information, and a digital signature

### Question 2

List components of a X.509 Certificate and CRL certificate.

### Solution

The structure of an X.509 v3 digital certificate is as follows:

- a. Certificate. Version Number.
- b. Serial Number.
- c. Signature Algorithm ID.
- d. Issuer Name.
- e. Validity period.
- f. Not Before.
- g. Not After.
- h. Subject name.
- i. Subject Public Key Info.
- j. Public Key Algorithm.
- k. Subject Public Key. ...
- l. Certificate Signature Algorithm.
- m. Certificate Signature.

Each entry in a **Certificate** Revocation List (CRL) include:

- a. the serial number of the revoked **certificate** and
- b. the revocation date.

The **CRL** file is signed by the **Certificate** Authority to prevent tampering

### Question 3

Which choice below most accurately describes SSL?

(i) It's a widely used standard of securing email at the Application level.

Solution

True

(ii) It gives a user remote access to a command prompt across a secure, encrypted session.

True

(iii) It uses two protocols, the Authentication header and the Encapsulating Security Payload.

False

(iv) It allows an application to have authenticated, encrypted communication across a network.

True

#### **Question 4**

List differences between SSL and TLS.

Solution

- a. The SSL and TLS protocols differ in their functions, authentication of messages, alert messages, record protocol, and encryption strengths.
- b. They are also different especially in issues of the procedure that's known as "SSL/TLS handshake." This procedure is done when both the parties (client and server) relate with each other.
- c. There is difference between how SSL and TLS in the way they each establish connections. For instance, the SSL handshake makes clear connections through a port. TLS, similarly, enables implied connections through protocol.
- d. The basic variance between SSL and TLS lies in these cipher suites that show an important role in the safety of the connection.

**The differences are further tabulated in the table below:**

<b>SSL</b>	<b>TLS</b>
SSL means "Secure Socket Layer."	TLS means "Transport Layer Security."
Netscape established the first version of SSL in 1995.	The first version of TLS was established by the Internet Engineering Taskforce (IETF) in 1999.
SSL is a cryptographic protocol that employs explicit linkages to develop secure transmission between web server and client.	TLS is also a cryptographic protocol that allows secure transmission between web server and client through implicit linkages. It was developed after the development of SSL protocol.
Three versions of SSL were released: SSL 1.0, 2.0, and 3.0.	Four versions of TLS were released: TLS 1.0, 1.1, 1.2, and 1.3.
All versions of SSL have been found susceptible, and they all have been	TLS 1.0 and 1.1 have been "broken" and are deprecated as of March 2020. TLS 1.2 is

deployed.

the most widely used protocol version.

### **Question 5**

What is S-HTTP?

### **Solution**

S-HTTP stands for Secure Hypertext Transfer Protocol

### **Question 6**

What are instant messaging and its vulnerabilities?

### **Solution**

Instant messaging is a method of sending messages to be received immediately.

The vulnerabilities are that they are used:

- a. to transport Viruses and worms
- b. to transport Identity theft/authentication spoofing
- c. For Firewall tunnelling

Explain them